

**REGIONAL
INFRASTRUCTURE
TECHNICAL
SPECIFICATIONS
(RITS)**

Updated May 2018



TABLE OF CONTENTS

1	GENERAL INFORMATION	3
2	EARTHWORKS AND GEOTECHNICAL REQUIREMENTS	71
3	TRANSPORTATION	81
4	STORMWATER.....	285
5	WASTEWATER.....	410
6	WATER SUPPLY	502
7	LANDSCAPE	544
8	ACCEPTABLE PRODUCTS	583

1 GENERAL INFORMATION

1.1	Introduction.....	6
1.1.1	The Infrastructure Technical Specification	6
1.1.2	Scope	6
1.1.3	Implementation of the RITS	8
1.1.4	Design Philosophy Statements and Alternative Design.....	8
1.2	Statutory Requirements, Standards and Related Documents.....	9
1.2.1	Statutory Requirements	9
1.2.2	Relationship with the District Plan.....	9
1.2.3	Building Act and Code	9
1.2.4	Relevant Standards and Other Documents.....	10
1.3	Acknowledgements, Abbreviations and Definitions	11
1.3.1	Acknowledgements.....	11
1.3.2	Abbreviations	11
1.3.3	Definitions.....	12
1.4	Three Waters Management	19
1.5	Resource Consents	19
1.6	Approval for Design Construction.....	20
1.6.1	Council Contracts	20
1.6.2	Development Works to be Vested.....	20
1.7	Site Development / Construction.....	28
1.7.1	Commencement of Work	28
1.7.2	Site Works	28
1.7.3	Standard Audits	28
1.7.4	Quality of Work	29
1.7.5	Stop Work Notices	29
1.7.6	Emergencies.....	30
1.7.7	On-Site Testing.....	30
1.7.8	Connection to Existing Services.....	30
1.7.9	Stormwater Quality	30
1.7.10	Stormwater Catchpits.....	31
1.8	Completion and Practical Completion.....	31
1.8.1	Quality Systems.....	31
1.8.2	Council Contracts	31
1.8.3	Development Works to be Vested.....	31
1.8.4	Defects Liability Period	32
1.8.5	Bonds for Uncompleted Works	32
1.9	As-Built Plans	33
1.9.1	General.....	33
1.9.2	Drawing Standards	34
1.9.3	Datums and Units of Measurement.....	34
1.9.4	Areas of Filling.....	34
1.9.5	Other Utility Services	34

1.9.6 As-Built Plan and Data Attributes	35
1.9.7 Submitting As-built Data	37
1.9.8 Threshold Matrix for As-Built Information	37
1.10 Traffic and Pedestrian Safety	38
1.11 Corridor Access Requests	38
1.11.1 Works Access Permits	39
1.12 Repair of Damage	39
1.13 Traffic Management	39
1.13.1 Temporary Traffic Management	39
1.13.2 Traffic Management Plans.....	39
1.13.3 Generic Traffic Management Plans	40
1.13.4 Site Specific Traffic Management Plans	40
1.13.5 Temporary Road Closures	40
1.13.6 School Sites	41
1.13.7 Bus Routes	41
1.13.8 Cyclists and Pedestrians	41
1.13.9 'Special' Parking Areas	42
1.13.10 Audits	42

LIST OF APPENDICES

Appendix 1A: Standard Symbols.....	43
Appendix 1B: Example As-Built Drawings.....	44
Appendix 1C: Three Waters Asset Attributes	50
Appendix 1D : Landscape (Parks & Facilities) Asset Data Forms	67

LIST OF TABLES

Table 1-1: Introduction to Sections of the RITS.....	7
Table 1-2: Abbreviations	11
Table 1-3 Definitions	12
Table 1-4: Influencing Policy's and Strategies.....	19
Table 1-5: Engineering Plan Descriptions	22
Table 1-6: Engineering Plan Requirements.....	23
Table 1-7: Supporting Documentation for Approval.....	26
Table 1-8: Drawing standard scales.....	34
Table 1-9: SHP Files.....	36
Table 1-10: DXF Files	36
Table 1-11: Threshold Matrix for As-built Information.....	37
Table 1-12: Three Waters As-Built Data Templates	50
Table 1-13: Stormwater Asset Attributes.....	51
Table 1-14: Wastewater Asset Attributes	58
Table 1-15: Water Asset Attributes	64
Table 1-16: Landscape Asset Data Forms	67

LIST OF FIGURES

Figure 1-1: Acceptance process.....	21
Figure 1-2: Standard symbols	43

LIST OF DRAWINGS

Drawing 1-1: Wastewater as-built plan..... 45
 Drawing 1-2: Stormwater as-built plan 46
 Drawing 1-3: Water as-built plan 47
 Drawing 1-4: Wetland as-built plan 48
 Drawing 1-5: Wetland as-built long section plan..... 49

LIST OF EQUATIONS

Equation 1-1: Asset value calculation 35

1.1 INTRODUCTION

The Regional Infrastructure Technical Specification (RITS) sets out the standards for design and construction of public infrastructure within the following councils' boundaries:

- Hamilton
- Hauraki
- Matamata-Piako
- Otorohanga
- South Waikato
- Waikato
- Waipa
- Waitomo

Wherever the term 'the Council' is used throughout this specification, this shall be deemed to refer to the relevant council in which the infrastructural work is being carried out.

1.1.1 The Infrastructure Technical Specification

The philosophy underpinning the Infrastructure Technical Specifications is to:

- a) Maximise the efficient use of infrastructural resources to ensure that any infrastructural development work is cost effective and appropriate for the long term.
- b) Provide a means to achieve requirements set down in the relevant district plan, resource consent(s), or contract when specified.
- c) Provide a means for alternative/innovative design and construction to be considered when undertaking infrastructure development or development works.
- d) Provide context and support to urban design when considering development works proposals.
- e) Be a "living" document that is easily updated as standards, construction or materials change as well as respond to matters amended in the relevant District Plan via plan change processes or similar.
- f) Be used for the design and construction of new infrastructure and for maintenance of existing infrastructure, including asset renewal, unless the standards are not compatible with the existing assets.

The RITS is the Council's acceptable technical specification. Some works will require specific design/specification i.e. large scale works, such as outlined in 1.1.4.2.

1.1.2 Scope

Any person undertaking infrastructure design and construction within the boundaries of any of the councils listed above via either:

- a) the Council's capital and/or operational works contracts or professional services agreements;

- b) development works regardless of whether the infrastructure will be vested in Council or remain in private ownership; or
- c) any other form of infrastructure development that will connect to Council’s existing infrastructure system;

shall use the RITS as the means of designing, constructing, testing and signing off development works within the council’s boundaries.

The Council acknowledges that the development of some infrastructure associated with the capital and/or operational works contracts will not be covered by the RITS.

Examples of such areas are:

- Reservoir construction
- Bulk water mains
- Interceptor sewers
- Other structures such as buildings

In these cases design and construction will be undertaken on an alternative design basis involving development engineers and project managers, relevant codes and standards and in accordance with accepted industry practice. This alternative design basis is outlined in 1.1.4.2.

The RITS incorporates the following sections:

Table 1-1: Introduction to Sections of the RITS

SECTION	TITLE	CONTENTS
1	General Information	<p>This section:</p> <ul style="list-style-type: none"> • Introduces the philosophy and use of the RITS; • Provides referencing and definitions for the RITS; • Identifies statutory requirements; • Outlines the three water management philosophy of the Council; • Describes the engineering approval process for subdivisions; • Provides generic specifications and guidance across all infrastructure groups for: <ul style="list-style-type: none"> ○ As-builts ○ Working in the transportation corridor ○ Temporary traffic management ○ General forms and checklists for subdivisions
2	Earthworks	<p>The earthworks and geotechnical section gives guidance on the requirements for assessment of land suitability and earthworks as part of a development. The development may include the construction of buildings, structures, roads, utilities, water courses and water bodies.</p>
3	Transportation	<p>This section builds on the transportation provisions of the relevant District Plan and sets out requirements and guidance for the design and construction of roads and the transportation network that incorporate facilities for vehicles, pedestrians, cyclists, public transport, utilities, and landscaping.</p>
4	Stormwater	<p>This section sets out requirements for the design and construction requirements for piped systems and stormwater treatment and detention devices.</p>

SECTION	TITLE	CONTENTS
5	Wastewater	This section sets out and details the technical requirements for the design and construction of wastewater systems. It covers the design of up to and including DN 225 pipes.
6	Water Supply	This section sets out requirements for the design and construction of drinking water supply systems. It covers the design of water pipes up to and including DN 250 mm diameter.
7	Landscape	This section sets out requirements for the design and construction of landscape and planting.
8	Acceptable Products	This section contains a list of products that have been accepted for use within the relevant council boundaries.

1.1.3 Implementation of the RITS

The RITS is governed by the requirements of the Local Government Act 2002.

The administration of the RITS is undertaken by the Local Authority Shared Services (LASS).

The RITS is a controlled document under the LASS's Quality System.

1.1.3.1 RITS Review

An initial review of the RITS will be carried out 6 months from date of publication. A further review will be carried out 12 months later, followed by two yearly reviews thereafter. Users will be invited to submit suggestions for improvement prior to each review.

Any user of the RITS has the ability to suggest improvements. All suggestions should be made in writing, preferably using the [suggestion form](#) on the Waikato Local Authority Shared Services website (www.waikatolass.co.nz) or sent to the LASS Secretary at regionalits@waidc.govt.nz. All suggestions will be considered prior to the next scheduled review, unless the suggestion is considered to be urgent. The originator will be advised of the decision made regarding their suggestion.

1.1.4 Design Philosophy Statements and Alternative Design

1.1.4.1 Design Philosophy

All designs submitted to the Council for approval shall be accompanied by a Design Philosophy Statement as detailed in Section 1.6.2.1. Note: this may not be required for smaller developments.

1.1.4.2 Alternative Design

The Council supports and encourages innovation and specifications/designs which add value. Alternative designs/specifications can be submitted provided the alternative specification meets or exceeds the RITS and addresses any operational and maintenance aspects. The alternative specification provided must include all relevant supporting information to enable assessment by the Council and be described in the Design Philosophy Statement.

Where a designer identifies a solution/product that is not currently accepted, an application should be made to the Council for the item to be considered – [see Section](#)

[8, Part B](#). Application and discussions for alternative products should occur at an early stage in the design process. A key consideration for council will be the impact on operations and ongoing maintenance requirements.

1.2 STATUTORY REQUIREMENTS, STANDARDS AND RELATED DOCUMENTS

1.2.1 Statutory Requirements

Infrastructure design and construction shall be carried out in accordance with the Regional Policy Statement and the relevant Council's district plan, strategies, bylaws and or policies. These can be found on the relevant Council's website.

The provisions and standards in the RITS shall be read in conjunction with the:

- Requirements of the relevant District Plan
- [Resource Management Act 1991](#)
- [Local Government Act 2002](#)
- [Building Act 2004](#)
- [Land Transfer Act 1952](#)
- [Unit Titles Act 2010](#)
- [Property Law Act 2007](#)
- [Local Government Official Information and Meetings Act \(LGOIMA\) 1987](#)
- [Health and Safety at Work \(General Risk & Workplace Management\) Regulations 2016](#)
- [Health Act 1956](#)
- [Health \(Drinking Water\) Amendment Act 2007](#)
- [Resource Management \(National Environmental Standard for Sources of Human Drinking Water\) Regulations 2007](#)
- [Waikato Regional Plan](#)
- [Waikato Regional Policy Statement](#)
- [Reserves Act 1977](#)

1.2.2 Relationship with the District Plan

The RITS is a document that sits outside the District Plan. If, when considering development applications, conflict occurs between standards outlined in the District Plan and the RITS then the District Plan takes precedence.

1.2.3 Building Act and Code

The Building Act and Code is the leading statute under which building development is undertaken to ensure that buildings are safe, sanitary and have suitable means of escape from fire. The building regulations enacted by the Building Act provide the requirements for building control in the form of the New Zealand Building Code. The Building Code contains objectives, functional requirements and performance criteria that building works must achieve.

The Building Code should guide all private infrastructure. There is reference in this RITS to the building code in relation to:

- a) Use of water sensitive techniques including:
 - (i) Grey water re-use
 - (ii) Green roofs
 - (iii) Soakage
- b) Private pipes especially those servicing multi-unit properties
- c) Private right of ways and shared access ways
- d) The construction of safety fences and rails

1.2.4 Relevant Standards and Other Documents

1.2.4.1 NZS 4404 Land Development and Subdivision Infrastructure

The Council recognises New Zealand Standard NZS 4404 and has used this as a basis for these specifications.

The RITS refers to NZS 4404 and its content throughout; therefore it is recommended that the RITS is considered in conjunction with NZS 4404.

1.2.4.2 Standards

A list of relevant standards and other references, including specifications, guidelines and other publications, is provided at the front of each section of this RITS.

1.2.4.3 Bylaws and Policies

There are a number of references in the RITS to bylaws, plans, strategies and policies. These can be found on the council's website - refer to the relevant council's bylaws and policies.

1.2.4.4 Environmental Plans

The following Environmental Plans shall be complied with and referenced within the catchment of the development or contract works

- Waikato -Tainui Environmental Plan
- Maniapoto Environmental Management Plan
- Raukawa Environmental Management Plan

1.2.4.5 Document Hierarchy

Where any conflict exists between any New Zealand Standard or other standard referred to in the RITS, then the specific requirements of the RITS take precedence.

1.3 ACKNOWLEDGEMENTS, ABBREVIATIONS AND DEFINITIONS

1.3.1 Acknowledgements

Waikato LASS acknowledges Hamilton City Council who have provided the template for the RITS.

1.3.2 Abbreviations

A list of abbreviations used throughout these specifications is as follows:

Table 1-2: Abbreviations

ABBREVIATION	DEFINITION
ARI	Average Recurrence Interval, sometimes known as ‘return period’. It is the average number of years that it is predicted will pass before an event of a given magnitude occurs. For example, a 50 year ARI event would on average happen every 50 years.
The Council	The relevant participating Council as listed in Section 1.1 Introduction .
CPTED	Crime Prevention Through Environmental Design – a crime prevention philosophy based on the premise that ‘proper design and effective use of the physical environment can produce behavioural effects that will reduce the incidence and fear of crime, thereby improving the quality of life.’ (Crowe, 1991, Crime Prevention Through Environmental Design: Applications of Architectural Design and Space Management Concepts).
CBR	The load-bearing strength of subgrade is measured by California Bearing Ratio (CBR) test.
CMP	Catchment Management Plan – a plan that considers the full hydrological catchment or sub-catchment and is specific to stormwater.
DN	Nominal internal diameter under the pipe manufacturing standard.
EPO	Environmental Protection Overlay
GRP	Glass Reinforced Plastic
HAIL	Hazardous Activities and Industries List
ICMP	Integrated Catchment Management Plan – a plan that considers the effects of the full hydrological catchment for stormwater and plans for water, wastewater and stormwater.
LASS	Local Authority Shared Services
MDPE	Medium Density Polyethylene
NZTA	New Zealand Transportation Agency responsible for the management and operations of the State Highway network and allocation of central government roading funds.
PE	Polyethylene
PVC	Polyvinyl Chloride
RAMM	Road Assessment and Maintenance Management and is a computer-based maintenance system that helps to manage the maintenance and renewal of all transportation assets.

ABBREVIATION	DEFINITION
RCC	Road Corridor Co-ordinator
RITS	Regional Infrastructure Technical Specification
RPZ	Reduced Pressure Zone Device or Backflow Prevention Device
RRPS	Road Reserve Planting Strategy
SW	Stormwater
TA	Territorial Authority
TMP	Traffic Management Plan
TTM	Temporary Traffic Management
WIA	Water Impact Assessment
WRC	Waikato Regional Council
WW	Wastewater

1.3.3 Definitions

In this Technical Specification, unless inconsistent with the context, the following shall apply.

Table 1-3 Definitions

TERM	DEFINITION
Access/Inspection Point	A place where access may be made to a connection for inspection, cleaning or maintenance as defined in the NZ Building Code.
Access Way (or Accessway)	As defined in s315(1) of the Local Government Act 1974.
Applicant	The person or company that submits the fully completed application to Council for the purposes of receiving Council's consent to subdivide land.
As-built Plan	A plan that depicts the final installed configuration and highlights any departures from the approved design.
Backflow	The unplanned reversal flow of water, or mixtures of water and contaminants into the water supply system.
Berm	A piece of land between the trafficable road surface and the road legal boundary. These areas may be grassed and contain a footpath, signs, streetlights, drainage, bunds or other street furniture.
BPO	Best Practicable Option: in relation to a discharge of a contaminant means the best method for preventing or minimising the adverse effects on the environment.
Bus Lane	A lane reserved by a marking or sign installed at the start of the lane and at each point at which the lane resumes after an intersection, for the use of buses and cycles, mopeds and motorcycles, unless either or both are specifically excluded by the signs.
Carriageway	An area of road reserve provided for the movement of vehicles and cycles or parking of vehicles.

TERM	DEFINITION
Cement Lining	An internal lining of a pipe, often sacrificial, to extend the life of the pipe from corrosive environments. Typically used to line the inside of steel pipes to protect from corrosion.
City	Hamilton City Council
CLM	Contaminant Load Model to determine contaminant concentrations predicted for the existing and proposed land-use scenarios.
Code of Practice for Temporary Traffic Management (COPTTM)	Part 8 of the <i>Traffic Control Devices Manual (TCD Manual)</i> which sets out the requirements for all temporary traffic management on State Highways and local roads. It includes the various levels of temporary traffic management, signs and forms used, and examples of traffic management plans.
Collector/Arterial Roads	Roads carrying greater than 1000 vehicles per day (vpd) but note that this is the HCC definition.
Connection	Wastewater and Stormwater Connection – also known as a lateral. A pipeline branch which has no terminal manhole structure which terminates in a private area for the purpose of connecting a premise. Water Connection – also known as service pipe. The section of water pipe between a water main and the point of supply.
Contractor	The company engaged to undertake the physical works on behalf of the council only, it does not relate to an applicant's/developer's contractor. The Contractor's responsibility shall be as defined by the General Conditions of Contract for the works.
Corridor Access Request (CAR)	The process by which utility organisations gain approval to work within the transportation corridor through an application under the National Code of Practice for Utilities' Access to the Transport Corridors.
Council representative Council officer	A person appointed by the Council to approve the Engineering work.
CSDC	Comprehensive Stormwater Discharge Consent defining stormwater consent conditions.
Cycle Lane	A longitudinal strip within a roadway reserved by a marking or sign for the use of cycles.
Cycle Path	A part of the road that is physically separated from the roadway that is intended for the use of cyclists, but which may be used also by pedestrians. This includes a cycle track formed under section 332 of the Local Government Act 1974.
Developer	The company or person who has been granted or holds planning consent for the land being subdivided or is responsible for the consent application. The Developer shall ensure that only suitably qualified and experienced professionals are appointed to undertake the design and supervision of the development works.
Developer's Representative	A suitably qualified professional appointed by the Developer to represent them, including registered Engineer and geo-professional (see definition below).
Disconnection	The physical cutting and sealing of any customer connections at the point of discharge or supply.
District	The relevant participating district council.
Drain (Private Drain)	Refers to the private wastewater or stormwater systems that connect the premise at the point of discharge. This section of drain is owned and maintained by the

TERM	DEFINITION
	customer or group of customers.
Footpath	A portion of any road, pedestrian accessway or public reserve that is laid out or constructed by authority of the Council primarily for pedestrians; and may include the edging, kerbing and channelling thereof.
Geo-professional	A suitably qualified and experienced Geotechnical Engineer, Engineering Geologist or Hydrogeologist holding membership with the Institution of Professional Engineers New Zealand (IPENZ) or equivalent professional body, including a current Professional Indemnity Insurance Policy acceptable to the Council
Greenfield Development	Development within the council's growth cells characterised by creating of new sections, roading and associated servicing infrastructure. Means subdivision and/or urban development of previously undeveloped rural land.
Groundwater Drainage	Subsoil drainage system to manage the water content within soils.
Gully Trap	Fitting designed to prevent foul air escaping from the drainage system and used to receive the discharge from private internal waste pipes.
Household Unit	Any building or group of buildings, or part thereof, used or intended to be used principally for residential purposes and occupied or intended to be occupied by not more than one household.
Infill Development	Redevelopment of urban land through either subdivision or Building Consent.
Infiltration	Groundwater entering a public sewer or private drain through defects such as poor joints and cracks in pipes or manholes. It does not include inflow.
Inflow	Water discharged into private drains from non-complying connections or other drain laying faults. It includes stormwater entering through illegal downpipe connections or from low gully traps.
Interceptor	Strategic gravity wastewater pipe with an external diameter of 525 mm or greater diameter.
Land Drainage System	The flow of stormwater and groundwater focussing on the control of peak surface water runoff, sediments and water quality for such discharges and their reticulation under urban conditions.
Level of Service	The expected performance level of infrastructure.
Local Authority	A regional council or territorial authority as defined in the Local Government Act 2002.
Local Roads	Roads carrying up to 1000 vehicles per day (VPD), note that this is the HCC definition.
Manhole	Service opening which allows access for inspection, cleaning or maintenance of a public wastewater or stormwater system.
Means of Compliance	The method by which the requirements of the relevant District Plan may be complied with. It implies that there may be other methods which may meet the requirement, but which may be subject to specific consideration or approval.
Natural Hazard	Any atmospheric or earth or water related occurrence (including earthquake, tsunami, erosion, volcanic and geothermal activity, landslip, subsidence, sedimentation, wind, drought, fire or flooding) the action of which adversely affects or may adversely affect human life, property, or other aspects of the environment.
Owner	The owner of the land being subdivided (may or may not be the Developer).

TERM	DEFINITION
Parking Bays	The parking spaces and associated manoeuvring areas of a road or proposed road (as defined by the kerb) which are accessed directly from the road
Pedestrian Access Ways	A path between two roads primarily for the use by pedestrians, these do not include paths on reserves.
Pedestrian Mall	A specified road or part of road that Council has declared a pedestrian mall as set out in Part 336 of the Local Government Act 1974 thereby prohibiting or restrict the driving, riding, or parking of any vehicle, or the riding of any animal, on all or any portion of the pedestrian mall either generally or during particular hours.
PE or Epoxy Lining	Trenchless underground relining and rehabilitation of existing pipes.
Point of Discharge	The boundary between the public sewer and private drain normally at the boundary of the property. Where a public sewer or stormwater system passes through private property the connection point shall be the upstream end of the pipe fitting which forms the junction with the public sewer or stormwater pipe.
Point of Supply	The point on the water pipe leading from the water main to the premises, which marks the boundary of responsibility between the customer and the Council, irrespective of property boundaries.
Potable	In relation to drinking water, means water that does not contain or exhibit any determinants to any extent that exceeds the maximum acceptable values (other than aesthetic guideline values) specified in the drinking-water standards applicable at the time.
Primary Design Flow	The estimated runoff selected to provide a reasonable degree of protection to the surrounding land.
Primary System (Stormwater)	The primary stormwater system is to accommodate a specified design rainfall event appropriate for the zone as defined in Section 4: Stormwater , Clause 4.2.3. It may include (but not limited to) wetlands, ponds, lakes, rain gardens, swales and filters, pipelines, inlet/outlet structures and soakage areas.
Principal Main	A water main of a minimum of 100mm internal diameter (DN 100) fitted with fire hydrants.
Private Road	Any roadway, place, or arcade laid out or formed within a district on private land, whether before or after the commencement of Part 315 of the Local Government Act 1974, by the owner thereof, but intended for the use of the public generally.
Private Treatment Device	Stormwater treatment device located on private land and maintained by the private owner.
Private Way	Has the meaning ascribed to it in Section 315 of the Local Government Act 1974. A private way is designed to provide vehicular and/or pedestrian access to a public street, and may comprise separately owned entrance strips subject to rights-of-way or a separate lot (access lot) which is jointly owned and used by adjacent lots. It includes any common area defined for the purposes of providing the vehicular access for cross-lease or unit title subdivision.
Professionals	Suitably qualified and experienced persons capable of undertaking the various activities associated with the planning and design phases of the project.
Prohibited Characteristics	Trade waste discharged containing the physical and chemical characteristics which the Council has determined must not be discharged into the public sewer system.
Public Treatment Device	Stormwater treatment device vested to and maintained by the Council. Usually providing treatment for large catchments.
Resource Consent	An authorisation given to certain activities or uses of natural and physical resources

TERM	DEFINITION
	required under the Resource Management Act (the RMA) by the Council and/or Regional Council.
Restricted flow supply	A type of water supply connection where a small flow is supplied through a flow control device, and storage is provided by the customer to cater for demand fluctuations.
Restrictor	A flow control device fitted to the service pipe to limit the flow rate of water to a customer's premises.
Rider Main	A water main of a minimum of 50 mm internal diameter (DN 50) up to DN 100.
Right of Way (ROW)	A piece of land for vehicular access and with rights as defined in the Property Law Act 2007.
Rising Main (RM)	A pressure main through which wastewater is pumped.
Road	Means all land comprising formed and unformed roads as defined in section 315(1) of the Local Government Act 1974.
Road Controlling Authority	The party that controls the road and is responsible for its operation and maintenance. This is typically the NZ Transport Agency for State Highways and the Territorial Authority for other public roads. Means the territorial local authority, agency or approved organisation in control of roads in accordance with section 317 Control of Roads of the Local Government Act 1974. Approved organisation is defined in the Land Transport Management Act 2003.
Road Culvert	A structure that allows water to flow from one side of the road to the other but does not connect to the council stormwater system. Typically embedded so as to be surrounded by soil, a culvert may be made from a pipe, reinforced concrete or other material.
Road Opening Notice	See Corridor Access Request.
Root protection zone	Means the minimum area required to ensure a tree's health and stability is safeguarded.
Rural Water Supply Area	An area formally identified by the Council as an area serviced by a reticulated water supply system that is intended to supply water for specified purposes via restricted flow supplies and/or on demand supplies but not necessarily with a fire fighting capability. (Refer to the Council's Water Supply Bylaw or GIS).
Secondary Flow Path	The path taken by stormwater runoff in excess of the primary design flow. Capable of providing protection to the surrounding buildings for a once in 100 years return period rain event for commercial, industrial, and habitable residential floor levels.
Service Lane	Any lane laid out or constructed either by the authority of the Council or the Minister of Works and Development or, on or after 1 April 1988, the Minister of Lands for the purpose of providing the public with a side or rear access for vehicular traffic to any land. Means land dedicated as service lane which is used from time to time for the vehicular servicing of adjacent properties.
Service Pipe	See 'Connection'
Service Vehicles	Vehicles that are used to service the needs of the residences, and undertake operation and maintenance activities on the infrastructure within the road corridor such as; rubbish trucks, road sweepers, recycling trucks, line marking trucks, resealing trucks.
Sewer / public sewer	See 'Wastewater System'

TERM	DEFINITION
Shared Zone	A length of road that is intended to be used by both pedestrians and vehicles, where pedestrians have the right of way over vehicles, as set out in the Land Transport (Road User) Rule 2004 clause 10.2
Shoulder	The portion of the side of the road that is not normally trafficked and resides between the solid white edge line and the edge of seal.
Special Vehicle Lane	A lane defined by signs or markings and restricted to a specified class or classes of vehicle; and includes a bus lane, a transit lane, a cycle lane, multiple occupancy lanes and a light-rail vehicle lane.
Subdivision	<p>As described in section 218 of the Resource Management Act 1991.</p> <p>Has the same meaning as contained within section 218 of the Resource Management Act 1991 which means:</p> <p>a) The division of an allotment:</p> <ol style="list-style-type: none"> i. By an application to a District Land Registrar for the issue of a separate certificate of title for any part of the allotment. ii. By the disposition by way of sale or offer for sale of the fee simple to part of the allotment. iii. By a lease of part of the allotment which, including renewals, is or could be for a term of more than 35 years. iv. By the grant of a company lease or cross-lease in respect of any part of the allotment. v. By the deposit of a unit plan, or an application to a District Land Registrar for the issue of a separate certificate of title for any part of a unit on a unit plan. <p>b) An application to a District Land Registrar for the issue of a separate certificate of title in circumstances where the issue of that certificate of title is prohibited by section 226.</p> <p>The term subdivide land has a corresponding meaning.</p>
Supply Pipe	The section of pipe between the point of supply and the customer's premises through which water is conveyed to the premises. This pipe is owned and maintained by the customer.
Survey plan	As described in Section 2 of the Resource Management Act 1991
Territorial Authority (TA)	A city council or a district council named in Part 2 of Schedule 2 of the Local Government Act 2002
The Works	The works shall generally be defined as the works for which this specification is being used and shall have the definition of 'Contract Works' as defined in NZS 3910:2013.
Trade Waste	Is any liquid, with or without matter in suspension or solution, that is or may be discharged from a trade premises to the Council's wastewater system in the course of any trade or industrial process or operation, or in the course of any activity or operation of a like nature; and may include condensing or cooling water or stormwater which cannot be practically separated.
Transit Lane	<p>A lane reserved for the use of the following (unless specifically excluded by a sign installed at the start of the lane):</p> <ul style="list-style-type: none"> • Passenger service vehicles • Motor vehicles carrying not less than the number of persons (including the driver) specified on the sign • Cycles • Motorcycles
Transportation Corridor	All Roads as defined above and includes all land from boundary to boundary (including the Berm and Carriageway).

TERM	DEFINITION
Tree Protection Zone	Minimum protection of existing trees in a work site is by erecting temporary fencing in a circle with a radius equal to the maximum crown extension (drip line) or 4m radius from the trunk – whichever is greatest.
Trunk Wastewater Pipe	A gravity wastewater pipe with in internal diameter of 225 mm to 450 mm which forms part of the Councils wastewater system.
Trunk Water	A strategic water main 250-375 mm diameter inclusive.
Urban Water Supply Area	An area formally designated by the council as an area serviced by a reticulated water supply system with a fire fighting capability, that is intended to supply water to customers via on demand supplies. (Refer to councils Water Supply Bylaw.)
USEPA	United States Environmental Protection Agency used for guidance on water quality maximum concentrations for the council's receiving environments.
Wastewater (sewage)	Water or other liquid, including waste matter in solution or suspension, discharged from a premises to the wastewater system.
Wastewater Reticulation Main	A gravity wastewater pipe with an internal diameter of 150 mm which forms part of the Councils wastewater system.
Wastewater System	The collection, treatment and disposal of wastewater and trade wastes, including all sewers, pumping stations, storage tanks, wastewater treatment plant, outfall and other related structures operated by Council and used for the reception, treatment and disposal of wastewater and trade wastes.
Watercourse	A watercourse is a natural or artificial channel that a flowing body of water follows. These include rivers, streams, branches and canals. If it is navigable it is a waterway.
Water Efficiency Measure	A Water Efficiency Measure is a water sensitive technique that has been confirmed as appropriate for specific catchments or developments in general. Specific Water Sensitive Techniques that are generally considered appropriate include (but not limited to) water re-use tanks, detention, permeable surfaces, soakage and bio retention. Appropriate Water Sensitive Techniques may also be identified within ICMP's and Water Impact Assessments prepared for catchments or individual developments respectively.
Water Impact Assessments	How the proposal is consistent with, or otherwise complies with, the recommendations, measures and targets of any relevant Integrated Catchment Management Plan.
WSD	Water Sensitive Design, an inter-disciplinary design approach for land-use planning and land development scenarios in both greenfield and brownfield applications, with specific focus on stormwater and freshwater management.
WQV	Water Quality Volume, the treatment volume used to assess efficiencies of existing devices and to determine sizing requirements for proposed devices. It is calculated using the Auckland TP10 guideline for stormwater management devices (or equivalent document).
Water-sensitive Techniques	A variety of methods that aim to achieve better outcomes for water related issues. They include many techniques referred to under other names e.g. Low Impact Design (LID), Low Impact Urban Design and Development (LIUDD), Sustainable Urban Drainage Systems (SUDS) 'natural', 'green' and 'sustainable'.
Water Supply System	All those components of the system between the point of abstraction from the natural environment and the point of supply. This includes but is not limited to: wells, infiltration galleries, intake structures, open raw water storage ponds/lakes, falling mains, treatment plants, treated water reservoirs, trunk mains, service mains, rider mains, pump stations and pumps, valves, hydrants, scour lines, service pipes, boundary assemblies, meters, backflow prevention devices and tobies.
Water Supply	Water Supply Authority (WSA), as defined in the Council's Water Supply Bylaw.

TERM	DEFINITION
Authority	

1.4 THREE WATERS MANAGEMENT

Pressure on water resources in the region is increasing due to a growing population and associated concentration of activities and industry. This pressure affects demand for water resources and Three Waters infrastructure (drinking water, wastewater and stormwater).

Well managed land-use planning is critical in minimising conflicts between infrastructure and land development to sustain water quality and quantity for future generations. It will also assist with the efficient and effective removal of waste and stormwater, while protecting and enhancing the natural environment.

The Council is required to give effect to a number of national and regional legislative drivers, industry standards and the Council’s own policy and plans.

1.5 RESOURCE CONSENTS

As a territorial authority, the Council manages significant resource consents from the Waikato Regional Council for conducting its responsibilities under various Acts and legislation. To ensure compliance with these consents Councils must impose their own standards and conditions on development within their boundaries.

Other key influences include:

Table 1-4: Influencing Policy’s and Strategies

INFLUENCE	SPECIFIC REQUIREMENTS
Waikato-Tainui Raupatu Claims (Waikato River) Settlement Act 2010	The overarching purpose of the Waikato River Settlements is to restore and protect the health and wellbeing of the respective rivers for future generations. These Settlements are supported by the Vision and Strategy for the Waikato River, Te Ture Whaimana o Te Awa o Waikato. One of the strategies from the vision and strategy is to “ensure that cumulative adverse effects on the Waikato River and activities are appropriately managed in statutory planning documents at the time of their review”. In order to ensure that the cumulative adverse effects on the Waikato River are managed, developments that require water, wastewater or stormwater connections will need to submit an Integrated Catchment Management Plan or Water Impact Assessment.
Drinking Water Standards for New Zealand 2005 (Revised 2008)	Infrastructure shall be designed and constructed to: <ul style="list-style-type: none"> • Ensure that the water system is functional • Ensure the required quality and quantity of water is supplied to all customers and the council’s Ministry of Health grading is not compromised
Regional Policy Statement (May 2016)	<i>Objective 3.12: Built Environment</i> requires integrating land use and infrastructure planning. This objective may be met by the development of Integrated Catchment Management Plans and Water Impact Assessments

1.6 APPROVAL FOR DESIGN CONSTRUCTION

1.6.1 Council Contracts

For Council contracts, refer to the relevant Contract Documentation for construction commencement. Contract documentation may refer to this RITS.

1.6.2 Development Works to be Vested

The Developer shall ultimately be responsible for all requirements and processes including:

- a) Interpreting the requirements of the Resource Consent, including any related regional council resource consent(s).
- b) Employment of a competent and suitably qualified engineer for all design works
- c) Submitting engineering plans and liaising with the Council staff throughout the engineering plan clearance procedure
- d) Construction monitoring of the physical works and certifying that the work has been completed to the required standards.
- e) Submission of as-built and associated documentation prior to vesting.
- f) Developers are strongly encouraged to consult with the Council on all infrastructure design, including landscaping, at an early stage of the development.

The following figure sets out the acceptance process.

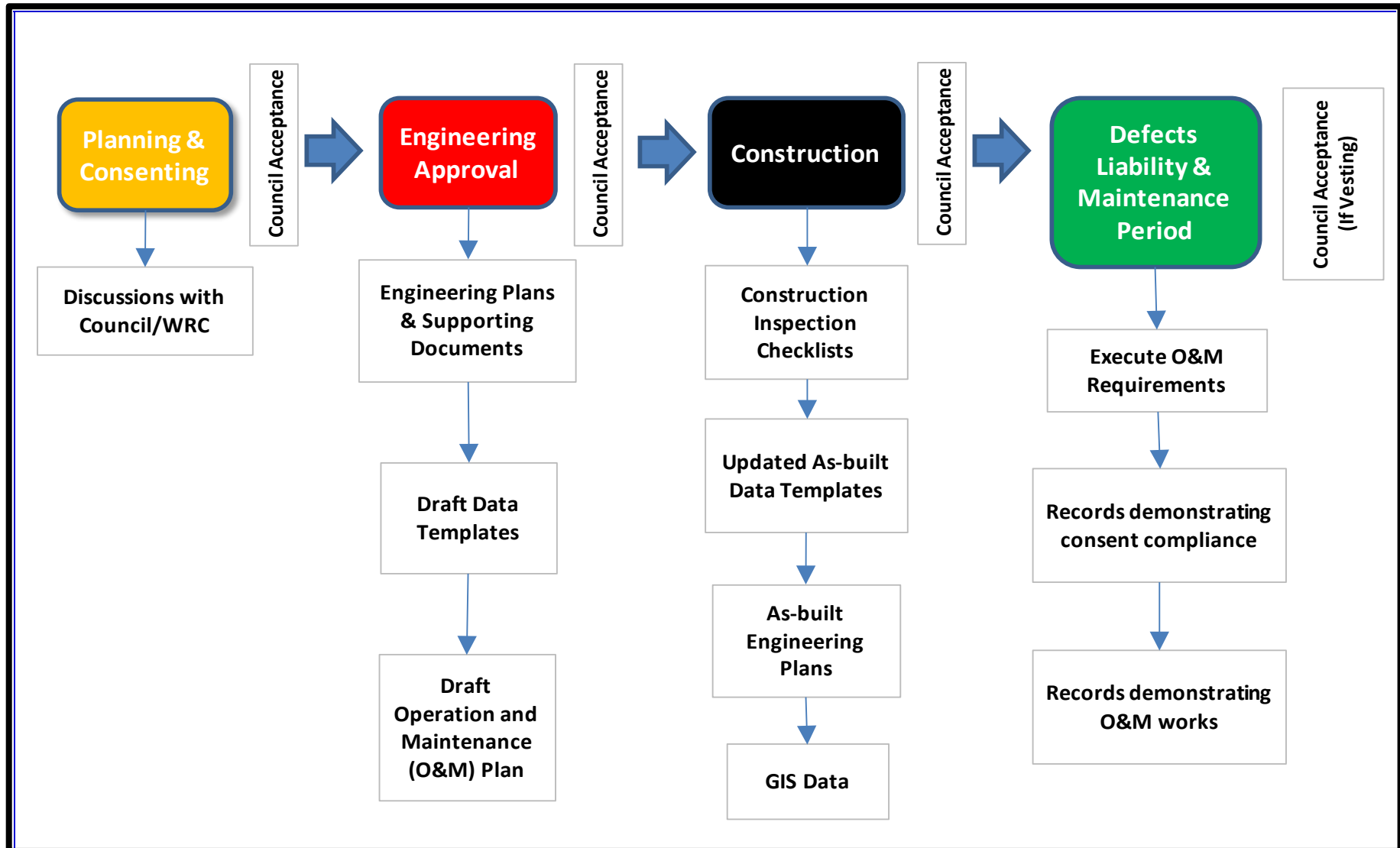

Figure 1-1: Acceptance process

1.6.2.1 Design Statements and Engineering Plans

All engineering plans shall be accompanied by a design statement which describes the proposed infrastructure and its relationship to the RITS. Any alternative design solutions shall be described in the design statement.

The design statement and engineering plans will be supported by the information summarised in Table 1-7: Supporting Documentation for Approval.

Acceptance of Engineering Plans and calculations is required before construction commences.

The following individual engineering plans shall be submitted for approval (see Table 1-6 for full plan requirements)

Table 1-5: Engineering Plan Descriptions

PLAN	DESCRIPTION
1. Locality Plan	Showing information sufficient to locate the subject site relative to existing features such as roads and already developed land, etc.
2. Earthworks Scheme Plan	Showing what earthworks are proposed (cut and fill contours) and any associated drainage requirements, and highlight any areas of slope stability concerns.
3. Road Layout	Including parking arrangements, footpaths, cycleway, road marking, signs, vehicle crossings and street lighting (both existing and proposed).
4. Stormwater Management System	Showing downstream and upstream systems, connections, disconnections, stormwater treatment, detention devices and overland flow paths, for both existing and proposed works.
5. Wastewater Reticulation	Showing downstream and upstream systems, connections, disconnections and pump stations, for both existing and proposed works.
6. Water Reticulation	Showing downstream and upstream systems, connections, and disconnections, for both existing and proposed works
7. Landscaping Plans	Note where applicable, landscaping plans shall be overlaid on to Road Layout Plans to show conflicts.
8. Staging Plan	Where the development is likely to be constructed in stages, a plan showing the pattern and chronology of the land development shall be submitted. The staging should have been decided as part of the resource consent application process.
9. Drawings of Standard Details	all Include drawings of all standard details to be used in the physical works, such as kerb and channel profile, cobblestone laying patterns, typical cross section showing footpath, berms, kerb and channel and pavement layers. For ducts a location diagram with measurements from reference points to the ends of the ducts and to any angles in the alignment.

Engineering plans should be submitted in their entirety to ensure prompt processing. The plans should clearly demarcate the extent of development that they refer to, private assets, and include any common features such as property boundaries.

Staged submission of detailed engineering plans may be considered where an overall concept plan (with supporting calculations) is submitted. Fully compliant and permanent “end treatments” are to be designed at the stage boundaries for water, wastewater, stormwater and roading.

Table 1-6: Engineering Plan Requirements

	PLAN VIEW	LONG SECTIONS	OTHER
Earthworks	<ul style="list-style-type: none"> • Original contours • Final contours • Overland drainage pattern • Cuts and fills • Provision for control of silt transport 		
Transportation	<ul style="list-style-type: none"> • Design centreline and meterage • Changes in surfacing material or age (e.g. concrete, surfacing Joins), changes in pavement design. • Horizontal alignment of kerb and channel including traffic facilities, with differing symbology for different K&C types • Secondary flow paths • Horizontal alignment of footpaths • Horizontal alignment of cycleways • Parking and Bus Bays • Location of vehicle crossings where known • Locations of ducts and other below ground features • Location of streetlight columns, with differing symbols for different light or column types. • The size, location and depth of all cables • Traffic signal details • Location of landscaping areas and street trees • Location of all street furniture including tactile pavers, bollards, handrails, guardrails • Traffic islands • Stormwater treatment devices within the road corridor • Road Marking 	<ul style="list-style-type: none"> • Existing ground levels at no greater than 0.5m intervals • Proposed final centre line levels • Cuts and fill • Grades • Vertical curve information • Location of catch pits or any other stormwater treatment devices • Location of intersecting roads • Location of pipelines 	<ul style="list-style-type: none"> • Cross Sections: • Proposed road • Typical cross sections showing pavement designs • Existing ground contour extending at least 3 metres into adjacent land • Road Marking and Signage • Location and types of signage • Location and alignment of all road markings • Separate construction drawings must be provided for retaining walls, bridges and underpasses
Stormwater	<ul style="list-style-type: none"> • Horizontal alignment of all pipelines relative to property boundaries or kerb lines as appropriate and tie-in to existing services • Easements • Location of all manholes 	<ul style="list-style-type: none"> • Existing ground levels • Proposed ground levels • Pipe depths inverts and grade • Pipe type size and class • Existing and proposed pipelines, cables and ducts 	

	PLAN VIEW	LONG SECTIONS	OTHER
	<ul style="list-style-type: none"> • Location of all conveyance, detention and treatment devices • Location of any open drain • Position of all property connections relative to property boundaries and the depth at the property boundary • Secondary flow paths including their easements • Site plan showing property boundaries, finished land level contours (maximum one metre interval), catchment and sub-catchment boundaries used in stormwater flow calculations together with label annotations providing a link to the stormwater runoff calculations. (Preferably show the stormwater drainage system on this drawing as well). • Construction plan details for stormwater treatment and detention devices; plan view to include contours at 0.5 metre interval and elevation view to show normal, discharge and overflow water levels • Location of catch pits, leads and manholes • Location of culverts and drainage, subsoil drainage and other drainage structures e.g. soakage devices 	<p>crossing the alignment</p> <ul style="list-style-type: none"> • Invert levels of all pipelines connecting to a manhole • Inlet, outlet and hydraulic information for all treatment and detention devices • Hydraulic grade line for the design storm 	
Wastewater	<ul style="list-style-type: none"> • Horizontal alignment of all pipelines relative to property boundaries or kerb lines as appropriate and tie-in to existing services • Location of all manholes • Location of all structures (including pump stations) • Position of all property connections relative to property boundaries • Show finished land level contours (not greater than 1 metre intervals – include RL labels on contours) 	<ul style="list-style-type: none"> • Existing ground levels • Proposed ground levels • Pipe depths inverts and grade • Pipe type size and class • Existing and proposed pipelines, cables and ducts crossing the alignment • Invert levels of all pipelines connecting to a manhole 	<ul style="list-style-type: none"> • Pump Station (including rising main and overflow) • Show all relevant details to enable the design to be audited and the structure constructed. • Construction drawing of pump station structure • Rising main plan and long section (including air and scour valves) • Water and electrical services to the pump station • Show the provision for pump station overflow in both plan and elevation views

	PLAN VIEW	LONG SECTIONS	OTHER
Water	<ul style="list-style-type: none"> Horizontal alignment of all pipelines relative to face of kerb (or boundary as appropriate) and tie-in to existing services Location of all valves Location of all hydrants and building sites to be provided with fire protection Pipe type, size and class Position of all property connections relative to property boundaries and the depth at the property boundary Location of all flushing valves 	<ul style="list-style-type: none"> Existing and proposed pipelines, cables and ducts crossing the alignment Pipe depths where it is planned for the pipeline to be at a different depth to that specified in the RITS. Long sections are required for pipelines of 250 mm NB and larger. The long section shall show existing and proposed pipelines, cables and ducts crossing the alignment 	
Landscaping	<ul style="list-style-type: none"> Landscaping plan with plant locations Furniture Playgrounds 		

Layout of Engineering Plans

All engineering plans shall have provision to be signed and dated as accepted by council, i.e. two spaces measuring 80mm by 40mm clear for stamping per plan.

Engineering Plans – Submitting Documentation

Engineering plans should be presented and submitted as per the as-built standards, Section 1.9

Acceptance of Engineering Plans

Prior to acceptance of engineering plans it may be necessary to amend drawings. It may also be necessary for accepted drawings to be amended due to unforeseen site conditions.

Amended drawings shall be:

- Submitted with an accompanying Document Transmittal Form; and
- Appropriately revision controlled

Changes to Accepted Engineering Plans

The accepted engineering plans may only be amended after consultation with Council and subsequent approval.

In all cases the changes must be documented and the amendments shown on the accepted engineering plans.

1.6.2.2 Supporting Documentation

In addition to the engineering plans the information presented in Table 1-7 is required prior to, during and after construction.

An erosion and sedimentation control plan will be required for all developments where runoff from a construction site can enter into either a Council stormwater system or open watercourse.

A health and safety plan shall be provided and approved by the Council if any works are in the public area i.e. roads, parks etc.

Table 1-7: Supporting Documentation for Approval

SECTION	PRIOR TO CONSTRUCTION COMMENCING	DURING CONSTRUCTION	AFTER CONSTRUCTION
Geotechnical Information	<ul style="list-style-type: none"> • Geotechnical Report • Contaminated Site Validation Report • Earthworks and Fill Design Report 	Construction monitoring	<ul style="list-style-type: none"> • Geotechnical Completion Report • Site Contamination Validation Report • Statement of Professional Opinion - - Schedule 2A (Appendix A, Section 2 : Earthworks) (adapted from NZS4404 Schedule 2A) • Final contour plan identifying areas of fill
Transportation	<ul style="list-style-type: none"> • See Section 3.7, Transportation Quality Systems • For traffic signals see section 3.6 • Road pavement design calculations including results of preliminary soil testing. • Approval for sub-soil drainage discharge (if appropriate) • Completed lighting design. • Road Safety Audits shall be required unless Council accepts an 'Exemption Declaration' • Design and Access Statement. See Section 3, Transportation Section, 3.1.7. • Producer Statement for design of structures. PS1 & PS2 if applicable. • Temporary traffic management plan for any work being undertaken within the existing road corridor • Approval of All Engineering Plans. See Table 1-6: Engineering Plan Requirements. 	<ul style="list-style-type: none"> • Construction monitoring • See Section 3.7 Transportation Quality Systems • For traffic signals see section 3.6 	<ul style="list-style-type: none"> • See Section 3.7, Transportation Quality Systems • For traffic signals see section 3.6 • Producer Statements for the construction of Structures (PS3), along with recommended maintenance schedules • Producer Statements for the construction of Private Ways • CoC or ESC signed by an authorized person for electrical work • Post Construction Road Safety Audit • Applicable warranties and guarantees for assets, including; <ul style="list-style-type: none"> ○ Streetlight Components and Coatings • As-built plans (refer Clause 1.9) • Quality forms (Appendix D) • As-built data forms (Appendix D)
Stormwater	<ul style="list-style-type: none"> • ICMP, CMP or WIA • Detailed catchment runoff calculations showing for each sub- 	Site Supervision	<ul style="list-style-type: none"> • CCTV Inspection and Report • Final operations and maintenance manuals for

SECTION	PRIOR TO CONSTRUCTION COMMENCING	DURING CONSTRUCTION	AFTER CONSTRUCTION
	<p>catchment the formula input factors used in the calculations</p> <ul style="list-style-type: none"> • Upstream and downstream effects • Detailed pipeline flow capacity analysis. • For stormwater treatment and detention devices, detailed analysis demonstrating the design performance in respect of stormwater quantity and quality as appropriate, including completed relevant sections of the stormwater management device datasheet. • Proposed operations and maintenance manuals for stormwater treatment and detention devices • Proposed landscaping plan for stormwater treatment and detention devices • A stage/storage/discharge table 		<p>stormwater treatment and detention devices</p> <ul style="list-style-type: none"> • As-built plans (refer Clause 1.9) <p>Asset attributes spreadsheets (Appendix C)</p>
Wastewater	<ul style="list-style-type: none"> • ICMP or WIA • Wastewater flow estimates supported by the estimates of population equivalents for each catchment together with catchment boundaries and catchment areas • Pipe flow calculations showing pipe capacity and flow velocity for average dry weather flow, peak daily flow and peak wet weather flow • Pump station calculations justifying the selection of wet well size, storage, pump selection and rising main hydraulics. 	Site Supervision	<ul style="list-style-type: none"> • CCTV Inspection and Report • As-built plans (refer Clause 1.9) • Asset attributes spreadsheet (Appendix C) • Pump station test results and sign off documentation
Water	<ul style="list-style-type: none"> • ICMP or WIA • Fire flow calculation 	Site Supervision	<ul style="list-style-type: none"> • As-built plans (refer Clause 1.9) • Asset attributes spreadsheet (Appendix C) • Pressure tests • Coliform tests
Landscaping	<ul style="list-style-type: none"> • Statement of design intent and design objectives • Plant schedule • Existing tree and vegetation plan • Maintenance schedule for weeding and replacement planting during Defects Liability Period 	Site Supervision	<ul style="list-style-type: none"> • As-built plans (refer Clause 1.9) • As-built data forms

1.7 SITE DEVELOPMENT / CONSTRUCTION

1.7.1 Commencement of Work

1.7.1.1 Council Contracts

For Council contracts, refer to Contract Documentation on Construction Commencement.

1.7.1.2 Development Works to be Vested

For developments the following shall apply:

Once engineering approval has been granted, the Developer shall inform Council of the intention to commence construction works. No engineering works shall commence on any subdivision or development until all approvals and acceptances (resource consents engineering and others) have been obtained.

Due to the size and complexity of the development, a pre-construction meeting may be required. At the pre-construction meeting, Council auditing procedures will be discussed and provisional dates and notification lead time for verification tests will be discussed. Where construction proceeds in stages, a separate pre-construction meeting shall be held for each stage.

1.7.2 Site Works

1.7.2.1 Council Contracts

For Council contracts refer to the Conditions of Contract and Specifications for construction auditing requirements.

1.7.2.2 Development Works to be Vested

For subdivisions the following shall apply:

- a) Developers are advised that the onus rests with them to ensure that works are to a standard acceptable to Council. Furthermore Developers are advised to retain the services of a suitable qualified or professional person(s) to certify works.
- b) Developers should carry out regular audits of the construction and maintain records of audits which will be submitted to Council on application for 224(c) or works sign off.
- c) In addition to the construction monitoring carried out by the Developer, Council will also audit the works.
- d) Auditing requirements for types of works are covered in the various sections. Council reserves the right to enter the work site at any time for auditing, inspecting or checking purposes.

1.7.3 Standard Audits

The following are key milestones that the Developer must notify to Council to enable any audit to be carried out if required.

- a) Commencement of work;
- b) Prepared earthworks and subsoil drainage prior to filling;

- c) Completed earthworks and prepared subgrade for carriageway, footpath cycleway and walkway;
- d) Commencement of stormwater, wastewater (including pump stations) and or water reticulation;
- e) Finished sub-base construction;
- f) Prior to commencement of carriageway surfacing.

Audits will be carried out within one working day of notification if possible. Work shall not proceed until the audit has been satisfactorily completed. When work has been interrupted or delayed, Council shall be notified before it is recommenced.

1.7.4 Quality of Work

1.7.4.1 Council Contracts

For Council contracts refer to the Conditions of Contract and Specifications for construction auditing requirements.

1.7.4.2 Development Works to be Vested

For subdivisions the following shall apply:

- a) The Developer is responsible for ensuring that the engineering works constructed by their Contractors are carried out according to these specifications, accepted plans and best work practices
- b) Council staff are not responsible for quality assurance
- c) The Developer shall be responsible for satisfactory completion of any Quality System Checklists required (refer to the individual sections for requirements). Where the Quality checklists require the presence of a Council representative, then the Developer shall make such arrangements as required. At least 24 hours' notice should be given
- d) General procedures/requirements and Quality Assurance forms are provided for use during construction, however, Council will accept Developers/Contractors/Agents own Quality Assurance forms that convey similar information
- e) Copies of completed checklists (found in the relevant section(s) of this RITS) shall be forwarded to Council as the works progress

1.7.5 Stop Work Notices

Any person or persons carrying out 'on site' works as part of any Council approved development project shall cease such work, or part thereof, immediately upon receipt of a written stop work notice specifying restrictions and issued by Council or an authorised agent.

The Developer has the right to appeal to Council to override or amend a stop work notice. A copy of Council's written decision will be recorded on Council's resource consent or project file. Work may recommence when the Council advises this in writing.

1.7.6 Emergencies

If a situation is observed that is likely to endanger the safety and/or the security of the public, public or private property, or the operation of any public facility, the Developer will be instructed to undertake remedial action to alleviate the danger and secure the site. Any such work or supply of materials will be at the Developer's expense.

1.7.7 On-Site Testing

Any work that requires testing in the presence of a Council officer shall be pre-tested and proved satisfactory by the Developer prior to the witnessed testing.

If the work does not meet the standard, then a fee will be charged for the second and any subsequent visit to re-measure or retest the work.

Specific testing regimes are set out in the relevant sections. Subsequent work dependent on a satisfactory test result shall not be undertaken until compliance has been demonstrated.

1.7.8 Connection to Existing Services

Connection of new stormwater, wastewater and water supply reticulation to existing systems shall be undertaken by Council using its standard procedures.

The new services must be tested and shown to meet all requirements prior to the connection being made.

1.7.9 Stormwater Quality

Stormwater quality is governed by the requirements of the Developer's discharge consent conditions, compliance with Waikato Regional Plan rules, an approved ICMP, CMP and consistency with Council's own stormwater consents.

The Developer shall be responsible for ensuring that mechanisms exist both during construction and at completion within the stormwater systems to prevent water-borne litter, such as paper and plastics, and gross sediments from entering the downstream system. Attenuation and quality treatment will likely be required. Design plans shall demonstrate how this is achieved.

The outcome will be that the design of the system will need to achieve the following as a minimum (more stringent requirements may be included within the CMP or ICMP or Discharge Consent):

- a) Avoid or minimise, the discharge of any substance that is likely to cause the production of conspicuous oil, or grease films, scums or foams, or floatable suspended materials in stormwater receiving water bodies
- b) Avoid or minimise, the discharge of suspended solids that causes conspicuous changes in colour or visual clarity, smothering of benthic organisms by sediment or make the receiving waters unsuitable for contact recreation
- c) Avoid or minimise, discharges that are likely to adversely affect aquatic ecosystems and cause the following effects in stormwater receiving waters after reasonable mixing and consideration of the background levels:
 - (i) Dissolved oxygen levels to fall below 80% of saturation

- (ii) pH to fall below 6 or exceed 9
- (iii) Suspended sediments to smother benthic organisms
- (iv) Undesirable biological growths
- (v) Water temperature to change by more than 3°C or exceed 25°C
- (vi) Turbidity levels to exceed 25 NTU between the months of August and December;
- (vii) Ammoniacal nitrogen concentrations to exceed 0.88 grams of nitrogen per cubic metre; and
- (viii) Other contaminant concentrations to exceed the United States Environmental Protection Agency National Recommended Water Quality Criteria (USEPA, 2009) - Criteria Maximum Concentration.

1.7.10 Stormwater Catchpits

Regular inspections of stormwater catchpits within and adjacent to the site works shall be carried out to ensure that stormwater contaminants do not enter into the stormwater system. All methods necessary to prevent sediment and other contaminants entering the catchpits shall be employed.

1.8 COMPLETION AND PRACTICAL COMPLETION

1.8.1 Quality Systems

Works clearance will not be considered until all certificates and quality assurance forms are complete and as-built plans/datasheets are received and accepted. Refer Table 1-7 for a list of requirements and the relevant activity sections of the RITS for the required forms.

The Developer/Contractor shall also submit, where required, completed producer statement forms and any specific testing results.

1.8.2 Council Contracts

For Council Contracts refer to the Condition of Contract, Specifications and NZS 3910 or NZS 3916 for Practical Completion and Final Completion requirements.

1.8.3 Development Works to be Vested

Works clearance is reached when the works described in the Conditions of Consent have been constructed. Any recommendations from the Road Safety Audit(s) shall also be implemented (refer clause 3.1.6) before works clearance is reached.

A works clearance will be issued when all infrastructure conditions have been met, subject to any bonds and defects liability periods. The 224(c) certificate can then be issued.

Completion is when all defects that have arisen during the defects liability period have been corrected.

The Developer is not liable for fair wear and tear.

1.8.4 Defects Liability Period

Works carried out during the development will be subject to a defects liability period of 12 months; however in specific circumstances, e.g. stormwater planting, this is likely to be increased to 24 months. The defects liability period commences from the date of issue of the 224(c) certificate (developments) or practical completion certificate (contracts).

Any works that are completed after the date of the issue of the 224(c) certificate will be subject to an extension of the defects liability period for 3 months following the completion of those delayed works.

1.8.5 Bonds for Uncompleted Works

The Council may consider accepting bonds to cover works that are uncompleted at the time of application for the 224(c) certificate and also work completed but potentially damaged.

The value of the bond will be set at one and a quarter times the estimated cost of the works for developments involving 10 or more lots/dwellings and twice the estimated cost of the works for smaller projects. In some circumstances however, such as planted stormwater devices that may have a long construction phase or a higher risk of failure, the bond may be increased to twice the estimated cost of the works.

The estimated cost of the works shall be as agreed between the parties or, in the absence of agreement, as estimated by Council. All costs associated with the provision of a bond will be the responsibility of the Developer.

A time for the work to be completed will be specified. If the work is not completed within time, the Developer may apply for an extension. Only one extension for time will be considered and the application must set out grounds for the request.

Once the specified time period has expired, including any extension granted, the Council will arrange for the work to be done. Funds for the work, including administration, will be charged against the Bond amount. Any remaining funds after payment of all costs will be refunded to whoever provided the bond.

It is the Developer's responsibility to inform the Council that the work is completed and to request an audit as a pre-requisite for the bond release. This request must be accompanied by certification stating the outstanding work has been completed to the required standard. There is a charge for this audit at the level set out in Council's Fees and Charges.

Where a Developer fails to request their bond release and Council is unable to locate them, Council may retain the bond money.

Refer Resource Management Act Section 222 and Section 224(c) (iii) in relation to bonds.

1.9 AS-BUILT PLANS

1.9.1 General

Upon completion of construction and prior to issue of work clearance/practical completion, copies of as-built plans showing details as constructed and certified as correct by the Developer/Contractor, shall be submitted to the Council. The plans will show all of the details as required by Table 1-6: Engineering Plan Requirements. These plans are required to update the Council's records and for archiving purposes.

Separate plans are required for:

- Roading (including plans for lighting, traffic signals and cables)
- Earthworks (finished contours)
- Landscape works (Parks & Facilities) - where not included in landscaping plans
- Stormwater, wastewater and water systems, including all stormwater treatment and detention devices and pump stations. For small developments refer section 1.9.8

Plans presented in fulfilment of this requirement shall be shown as "As-Built" in the amendments part of the drawing title block and signed-off as 'approved for issue' by a person having responsibility for the quality assurance aspect of the as-built information.

General information to be shown on as-built plans includes:

- a) All attributes identified in [Appendix 1A](#).
- b) Name of company and person who prepared the as-built plans
- c) Drawing Title with project name or subdivision name (including subdivision stage number)
- d) Unique drawing number
- e) Council contract number (Council projects)
- f) Council project ledger code (Council projects)
- g) Plan revision
- h) Date when signed
- i) Lot boundaries as submitted to Land Information New Zealand including legal descriptions (in the case of subdivisions)
- j) Lot numbers and house numbers
- k) Datum reference
- l) Origin benchmark reference, reduced level and coordinates
- m) Scale bar
- n) North arrow
- o) Legend
- p) New assets (and tie-in to existing assets)
- q) Existing assets, notated with Council's asset reference/identifier
- r) Abandoned or removed assets
- s) Plans for wastewater, stormwater and water supply must use the line formats and symbols as indicated in [Appendix 1A: Standard Symbols](#).

Note: Occasionally privately owned assets need to be shown on as-built plans; such assets shall be clearly labelled 'Private ...asset type' e.g. Private SW Manhole.

Lists of specific assets, their attributes to be shown on plans together with example as-built drawings are contained in the appendices of this section.

Construction plans are not acceptable as as-built plans.

1.9.2 Drawing Standards

Drawings shall be A3 size, and must be scalable using the following scales:

Table 1-8: Drawing standard scales

Plan and long section	Horizontal	1:1000, 1:500, 1:250
	Vertical	1:100, 1:50
Cross Sections	Horizontal	1:100
	Vertical	1:50

In all cases the plan size must be appropriate for the level of detail shown.

In particular, use of 1:1000 scale is to be confined to site plans, roading and three waters layout plans.

1.9.3 Datums and Units of Measurement

Only metric units are to be used in as-built data. Principally these are millimetres (mm), metres (m), litres/sec (L/s), cubic metres /day (m³/day).

- a) All levels are to be in terms of the Moturiki Datum 1953 and to two decimal places.
- b) Geographic coordinates shall be:
 - (i) New Zealand Geodetic Datum 2000 (NZGD2000)
 - (ii) Projection: New Zealand Transverse Mercator (NZTM) or Mt Eden Circuit 2000

Coordinates should be presented in standard 6 digit format (east coordinate followed by north coordinate) to 2 decimal places e.g. 305718.97, 643728.35.

Accuracy of coordinates shall be for: X, Y within +/-0.1m, Z within +/-0.01m.

1.9.4 Areas of Filling

The areas of filling shall be shown by contours showing the depth of fill in the form of lines, joining all points of equal fill depth, or by contours showing original ground levels and finished ground levels.

1.9.5 Other Utility Services

In applying for works completion, the Developer/Contractor shall submit the appropriate checklists from all other utility system operators confirming that they have received the required as-built information.

1.9.6 As-Built Plan and Data Attributes

The following files and data attributes are required to facilitate the easy transfer of data into Council’s asset management system.

Electronic spreadsheets, listing various attributes of the assets constructed, and as-built data forms, are listed in the appendices and available from the LASS website.

Three waters attribute data templates are listed in [Appendix C](#).

Note: Levels are to be in metres (m), in terms of Moturiki datum

1.9.6.1 Transportation As-built Data Sheets

Quality forms and as-built data sheets for transportation data are in [Appendix 3B Transportation Asset Data Forms](#).

1.9.6.2 Landscape Works

Quality forms and as-built data sheets for landscape works (parks & facilities) are listed in [Appendix 1D Landscape \(Parks & Facilities\) Asset Data Forms](#).

Where construction or land development works involve landscaping to be owned/managed by the Council, an as-built plan of landscaping works shall be provided to Council showing the following details:

- a) Location and extent, types of materials
- b) Botanical and Common name and location (measured position in the berm) of street trees
- c) Names, grades, number, planting density of traffic island planting

1.9.6.3 Asset Value

The Council is legally required to maintain an asset valuation register for all infrastructure assets. The asset value is calculated as:

Equation 1-1: Asset value calculation

$$AssetValue = AssetDirectCost + \left(\sum IndirectCosts \times \frac{AssetDirectCost}{\sum AssetDirectCosts} \right)$$

Whereby:

- a) Asset Direct Costs include materials and installation/construction cost
- b) Indirect costs include such items as professional fees for design and construction supervision, resource consents, insurance and traffic control
- c) All values shall be exclusive of GST

1.9.6.4 Files

Council’s preference is for ESRI ArcGIS Shape (SHP) files but Data Exchange (DXF) or DWG files may be accepted. In any case a PDF copy of the plans should also be provided.

SHP Files

SHP format files are to be supplied containing the points and line-work connecting assets together in the following format.

- a) File Format: ESRI SHP (with “.shp” Suffix)
- b) Projection: Mount Eden Circuit 2000 or NZTM
- c) PDF copy

Separate files are required for the three asset groups and a fourth file is required for the property boundary and road information:

Table 1-9: SHP Files

SHP FILE NAME	SHP FILE CONTENT
BD.shp	Road Centrelines, Property and Road Boundary Vectors and lot numbers
WW.shp	All Wastewater Assets
WS.shp	All Water Supply Assets
SW.shp	All Stormwater Assets

- a) Each pipe shall be represented by a single continuous line i.e. the pipe centreline
- b) Feature location X, Y, Z coordinates are to match the requirements identified in the relevant technical specification
- c) Each pipe shall run continuously between manholes and other junctions (and broken at manholes or junctions)
- d) The pipe is NOT to be broken by service connections or laterals
- e) All point assets such as manholes, valves, hydrants shall be snapped to their associated pipe and vice versa
- f) Each pipe (including service connections) shall be captured in the direction of flow, except in the case of watermains and ducts
- g) Each SHP file shall have only one asset type in it, e.g. water or wastewater or stormwater, and separate layers should be used for each asset e.g. water pipe layer, water valve layer, stormwater manhole layer etc.
- h) All stormwater management devices shall be represented by a polygon outlining the device footprint, the treatment catchment and the hydrological catchment draining to the device

DXF Files

DXF format files are to be supplied containing the points and line-work connecting assets together in the following format.

- a) File Format: Release 1 ASCII DXF (with “.DXF” Suffix) or later release
- b) Projection: Mount Eden Circuit 2000
- c) PDF copy

Separate files are required for the three asset groups and a fourth file is required for the property boundary and road information:

Table 1-10: DXF Files

DXF FILE NAME	DXF FILE CONTENT
BD.dxf	Road Centrelines, Property and Road Boundary Vectors and lot numbers

WW.dxf	All Wastewater Assets
WS.dxf	All Water Supply Assets
SW.dxf	All Stormwater Assets

- a) Each pipe shall be represented by a single continuous line i.e. the pipe centreline
- b) Feature location X, Y, Z coordinates are to match the requirements identified in the relevant technical specification
- c) Each pipe shall run continuously between manholes and other junctions (and broken at manholes or junctions)
- d) The pipe is NOT to be broken by valves, hydrants, service connections or laterals
- e) All point assets such as manholes, valve, hydrants shall be snapped to their associated pipe and vice versa
- f) Each pipe (including service connections) shall be captured in the direction of flow, except in the case of water mains and ducts
- g) The pipe network shall be in a single continuous file/drawing (not tiled or split in any form)
- h) Each DXF file shall have only one asset type in it, e.g. water or wastewater or stormwater, and separate layers should be used for each asset e.g. water pipe layer, water valve layer, stormwater manhole layer etc. Do not include property boundaries, road labels, text, tables etc. in these DXF files
- i) All symbology such as manholes should be 'exploded' prior to saving as a DXF file
- j) All stormwater management devices shall be represented by a polygon outlining the device footprint, the treatment catchment and the hydrological catchment draining to the device

All long-sections shall be provided as a PDF.

1.9.7 Submitting As-built Data

As-built requirements shall be sent to:

- a) In the case of subdivisions -

E-mail electronic files to: [asbuilt@xxxxx\(Council\).govt.nz](mailto:asbuilt@xxxxx(Council).govt.nz)

Include in the subject heading: Subdivision Consent Number, subdivision name and stage number.

- b) In the case of Council contracts - send to the Engineer as instructed in the contract documents.

1.9.8 Threshold Matrix for As-Built Information

For small developments (up to 2 lots) the provision of separate as-built plans and attribute data for each service with SHP or DXF files are not justified. Therefore the following matrix has been developed to guide when each type of data presentation is required. If the data presented is not clear, the Council may still request additional information.

Table 1-11: Threshold Matrix for As-built Information

	SMALL DEVELOPMENT (≤2 LOTS)	MEDIUM DEVELOPMENT (3 TO 10 LOTS)	LARGE DEVELOPMENT (>10 LOTS)	CONTRACT
Separate plan for each service	No	Not required if adequate clarity is possible on same plan	Yes	Yes, unless specified otherwise in contract documents
SHP or DXF Files (DXF files shall identify individual reticulation assets, lines or points)	Please supply if available	Yes	Yes	As above
Asset Attribute spreadsheet files	No, include information on plans, no coordinates required.	Yes	Yes	As above
Roading as-built data sheets	Yes	Yes	Yes	As above
GST invoice on vesting	Yes	Yes	Yes	As above
PDF plan size	A3	A3	A3	A3

1.10 TRAFFIC AND PEDESTRIAN SAFETY

The Developer shall take all reasonable measures to protect the public from the adverse effects of the work. Particular attention should be paid to the erection and maintenance of temporary fencing, especially in areas of potential ponding. Signs shall be erected warning of danger within the site area. These protection measures should be shown in the accepted Health and Safety Plan.

Where any work is in, or affects, any road, footpath, cycleway, walkway, vehicle access, service lane, carpark or other area that the public has the right of access to, the Developer/Contractor shall maintain safe, readily negotiable passage across or around the work site for all types of traffic, including pedestrians and cyclists. Access to public and private property shall be maintained at all times unless prior arrangements, acceptable to all parties, have been made.

1.11 CORRIDOR ACCESS REQUESTS

All excavation and trenching work carried out within the road corridor must be carried out in accordance with the [National Code of Practice for Utilities Operators Access to the Transport Corridors](#) and the [Code of Practice for Temporary Traffic Management](#).

Any person or business planning to dig up part of the road/berm as part of a project (including smaller projects such as installing a new driveway, laying water pipes or holding an event) must have an approved Corridor Access Request. If work is being carried out on private property or business property but needs to use some of the road reserve, refer to council's website for the process and consider whether a Corridor Access Request (CAR) is required.

A Corridor Access Request application can be made by going to the [BeforeUDig website](#), (Excavations and Utility Installations) or [Corridor Access Request website](#) (Non-

Excavations and Events) registering, filling in an application form including a sketch or plan of the location and works, and then clicking "submit".

A Traffic Management Plan will also need to be submitted when applying for a Corridor Access Request. This can be done at the same time as the application. To find out more about Traffic Management plans, visit the council's website.

Fees are applicable for applications from Utility Operators for access to the Council's transport corridor in accordance with the National Code of Practice for Utility Operators Access to Transport Corridors (issued 2014). A link to the latest fees can be found on the council's website.

Where works are proposed that affect roads from an adjoining District Council or a State Highway, the Developer/Contractor shall obtain additional approvals from that authority.

1.11.1 Works Access Permits

The Local Conditions of each council apply to all Work Access Permits issued within that council in accordance with the National Code of Practice for Utility Operator's Access to the Transport Corridor (the Code).

A copy of the relevant Local Conditions can be found on the relevant council's website:

1.12 REPAIR OF DAMAGE

The Developer/Contractor shall be solely responsible for all damages that may result from their operations, and shall satisfy Council that they have made proper reinstatement. Should no satisfactory efforts be made by the Developer/Contractor within a reasonable period of time, Council may seek another Contractor to carry out the reinstatement to the full requirements of Council. All costs resulting from the work will be deducted from any monies due, or which may become due, to the Developer/Contractor.

1.13 TRAFFIC MANAGEMENT

1.13.1 Temporary Traffic Management

Temporary Traffic Management (TTM) must be established on every site where work is to be undertaken within the transportation corridor, where a public road or footpath is affected, either directly by the works or the Contractor's access to or from a site.

1.13.2 Traffic Management Plans

A Traffic Management Plan (TMP) must be prepared and implemented in accordance with the Code of Practice for Temporary Traffic Management (CoPTTM). This plan must be prepared by a qualified Site Traffic Management Supervisor (STMS) and submitted to the Council via Beforeudig.co.nz (excavations) or www.corridoraccess.co.nz (events) for approval. A copy of the approved plan must be held on site and be available for checking.

TMPs for complex projects or those that cover an extended time period may need several layout plans for various stages of the work. Revised or additional TMPs should be submitted if there is a significant change in circumstances.

1.13.3 Generic Traffic Management Plans

For work that is repeatable and has minor effect on traffic, Contractors are encouraged to submit generic TMPs for typical work activities. Once approved these plans may be implemented throughout the council area (other than State Highways).

The STMS or Traffic Controller (TC) must ensure the TTM is appropriate for the site and make any adjustments to the generic TMP that are necessary. All generic TMPs are to be reviewed and submitted for re-approval at a maximum of 12 monthly intervals and at any other time a significant change is identified as necessary.

1.13.4 Site Specific Traffic Management Plans

For any site where either:

- a) A reduction in the number of traffic lanes on arterial roads is proposed; or
- b) A major intersection such as a roundabout or signals is involved; or
- c) There is no suitable generic TMP applicable, a site specific TMP shall be prepared and submitted for approval at least 5 days before work commences via Beforeudig.co.nz

1.13.4.1 State Highways

When the Contractor is planning to carry out an activity within the State Highway road reserve (boundary to boundary) an Approval to Work on the State Highway (ATWOSH) application and an accompanying Traffic Management Plan is required to be submitted for approval to the NZTA Network Consultant.

1.13.4.2 Arterial Roads

Apart from emergency works, no work that interferes with traffic flow on arterial roads shall be carried out during the peak traffic periods of 7.30am–9.00am and 4.00pm–5.30pm Monday to Friday, or during major public events, without specific approval from the Council's Road Corridor Co-ordinator (RCC).

1.13.5 Temporary Road Closures

The Contractor or applicant may apply for a temporary closure of a road or part thereof in order to carry out the works.

The application must demonstrate that either:

- The closure is essential to allow the works to be built or run safely; or
- A closure will allow the works to be completed more efficiently, taking into account the direct construction costs, the costs of delays to road traffic and the costs of increased travel distance

If permission for a temporary road closure is given, the Contractor shall prepare and submit for approval a TMP that includes:

- a) A suitable detour around the closure
- b) Access for public having legitimate purpose or business in the affected area.
- c) Access to public and private property unless prior arrangements suitable to all parties have been made.

- d) Immediate access to any emergency services and provision to curtail or cease work if necessary.
- e) Suitable arrangements for the regular refuse and recycling collections, either by allowing the collection vehicles to access the site or taking the refuse and recyclables to one end of the job for collection. Any wheeled bins and recycling crates must be returned to the location they were collected from.
- f) Alternative routes for public bus services affected, including temporary bus stops.
- g) 2 weeks advance notification to all affected parties including on site signage prior to the closure, public notices via the weekly road works reports and press/media releases.
- h) The RCC will arrange further publicity for significant closures.
- i) Events will require 42 days public notification in accordance with the Local Government Act.

1.13.6 School Sites

Special attention is to be paid to works outside or adjacent to school or preschool institutions. Ideally such works will be undertaken outside school hours and no footpath closures will occur.

No work shall be undertaken on school days within 200 metres of a school between 30 minutes before or after the school bell in the mornings and afternoons. Consultation with the school should be undertaken to determine the start and finish times of the school, as they vary. Many schools have a 40 km/hr. speed zone. TMPs for work within these areas shall incorporate the 40 km/hr. speed restrictions as necessary.

Provision for the continued operation of any school patrols shall also be considered in consultation with the school, and if necessary, provisions for alternative safe crossing facilities will need to be included within the TMP.

1.13.7 Bus Routes

If a work site is on a regular bus route and is likely to disrupt bus operations the Contractor shall ensure that the Waikato Regional Council and bus route operator(s) are advised of the works at least:

- a) 72 hours prior to commencement for minor interruptions; or
- b) 10 working days prior to commencement for major interruptions that will require an alternative route or bus stops. The Contractor shall co-operate with making any changes needed to minimise adverse impacts on the bus services.

1.13.8 Cyclists and Pedestrians

The Contractor shall ensure that both pedestrians and cyclists have safe access past the site where required.

In particular:

- a) No TTM signs are to be placed in marked cycle lanes or block footpath access.
- b) Provision must be made for pushchairs, mobility scooters etc. including kerb ramps if there is no suitable crossing
- c) Particular care must be taken near schools and preschools
- d) The surface shall be reasonably smooth and usable in all weather conditions

1.13.9 'Special' Parking Areas

If 'Special' parking areas such as marked bus stops, taxi stands, loading zones, mobility parks or metered parking bays are affected by the works these shall be identified in the TMP and suitable alternative facilities provided, if required by Council.

1.13.10 Audits

Council may carry out random audits of any site in accordance with CoPTTM procedures and the results will be forwarded to the Developer/Contractor. Any site scored as 'Dangerous' will be immediately closed down until the necessary improvements have been made. As required by CoPTTM a 'Notice of Non Conformance' will be issued for a Dangerous site. The on-site Traffic Controller or STMS will be advised about any site scored as 'Needs Improvement'. The improvements are required to be implemented by the next working day.

APPENDIX 1A: STANDARD SYMBOLS

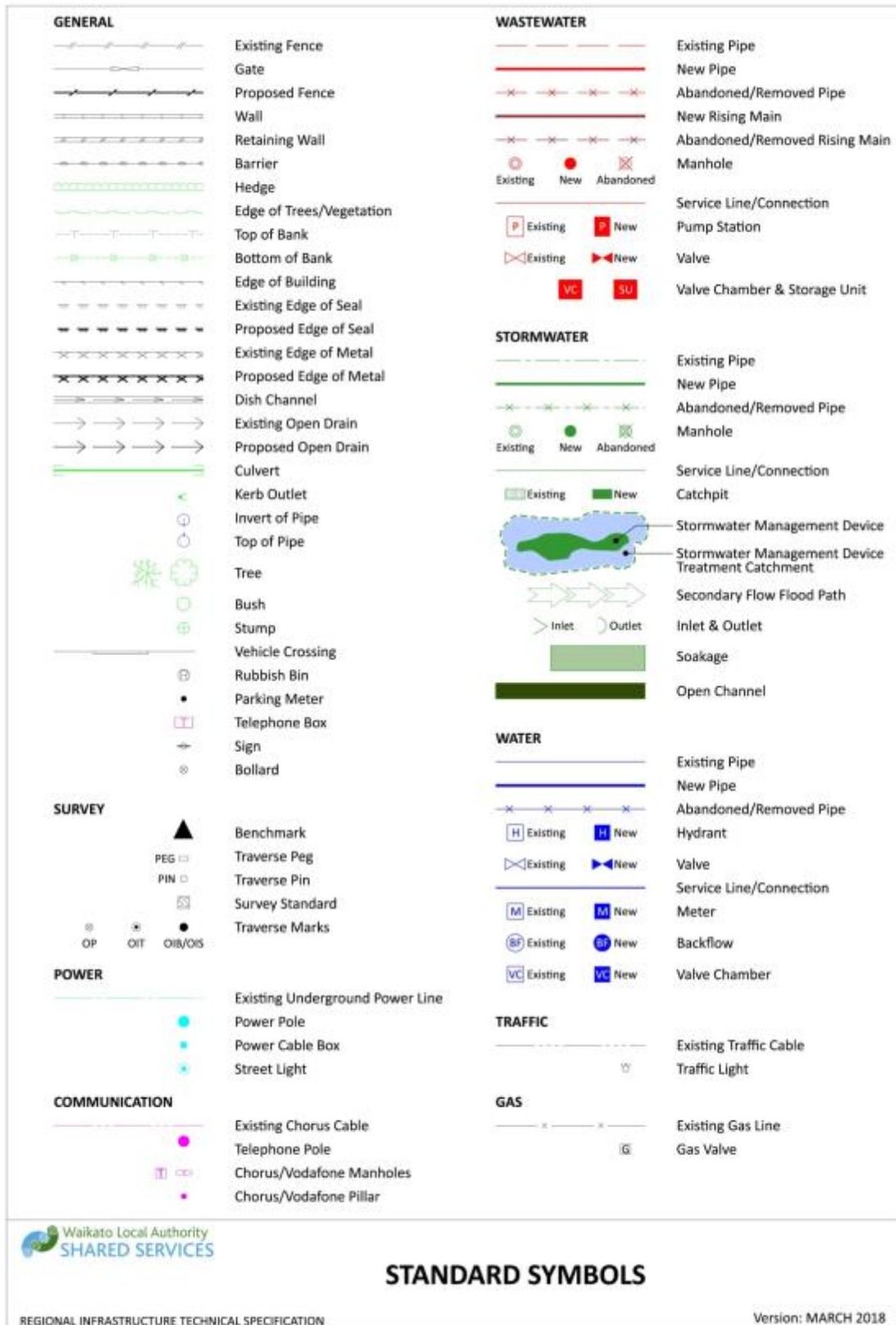

Figure 1-2: Standard symbols

APPENDIX 1B: EXAMPLE AS-BUILT DRAWINGS

[Wastewater see Drawing D1.1](#)

[Water supply see drawing D1.3](#)

[Stormwater network see Drawing D1.2](#)

[Wetlands see Drawing 1.4.1](#) and [Drawing 1.4.2](#)

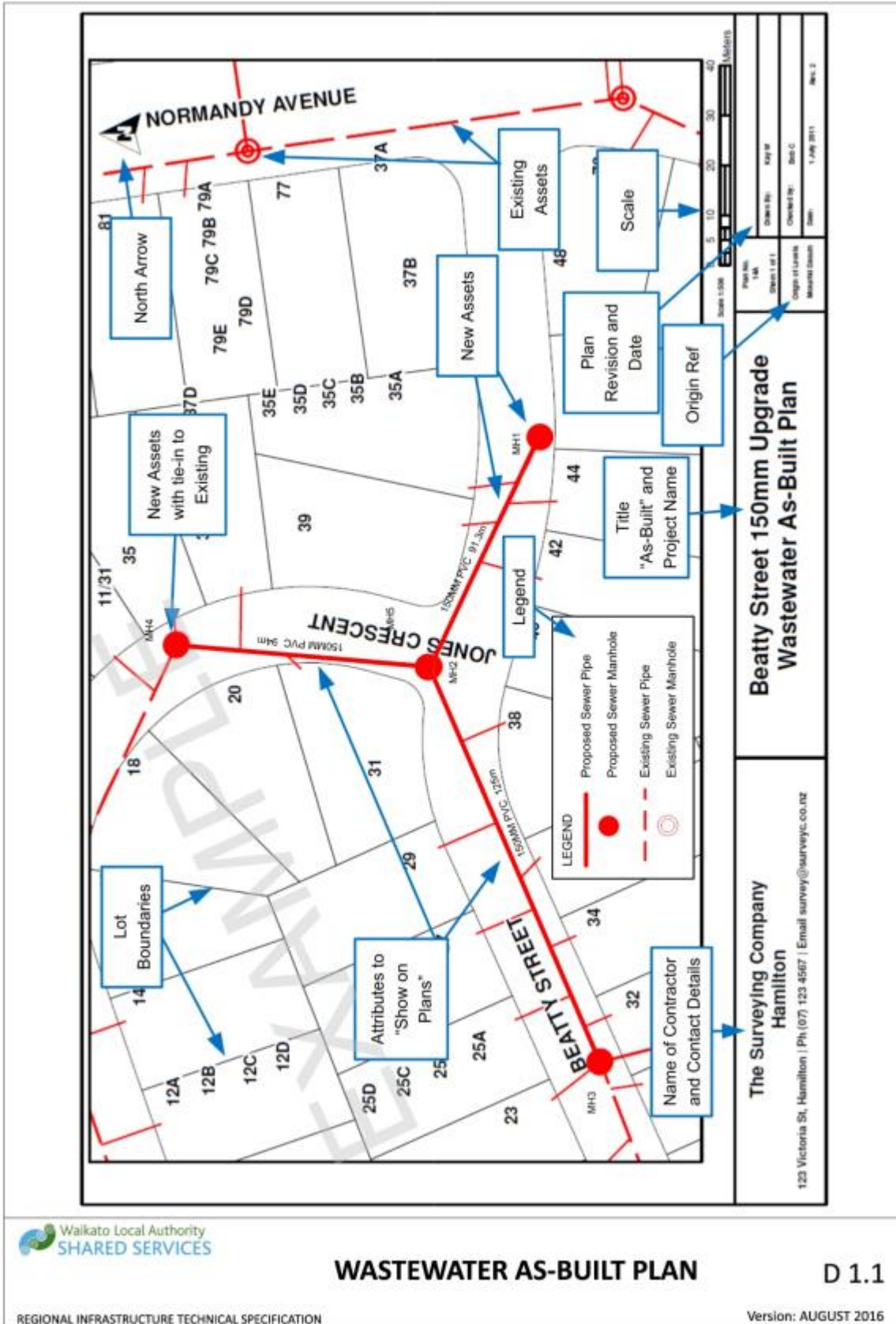

Drawing 1-1: Wastewater as-built plan

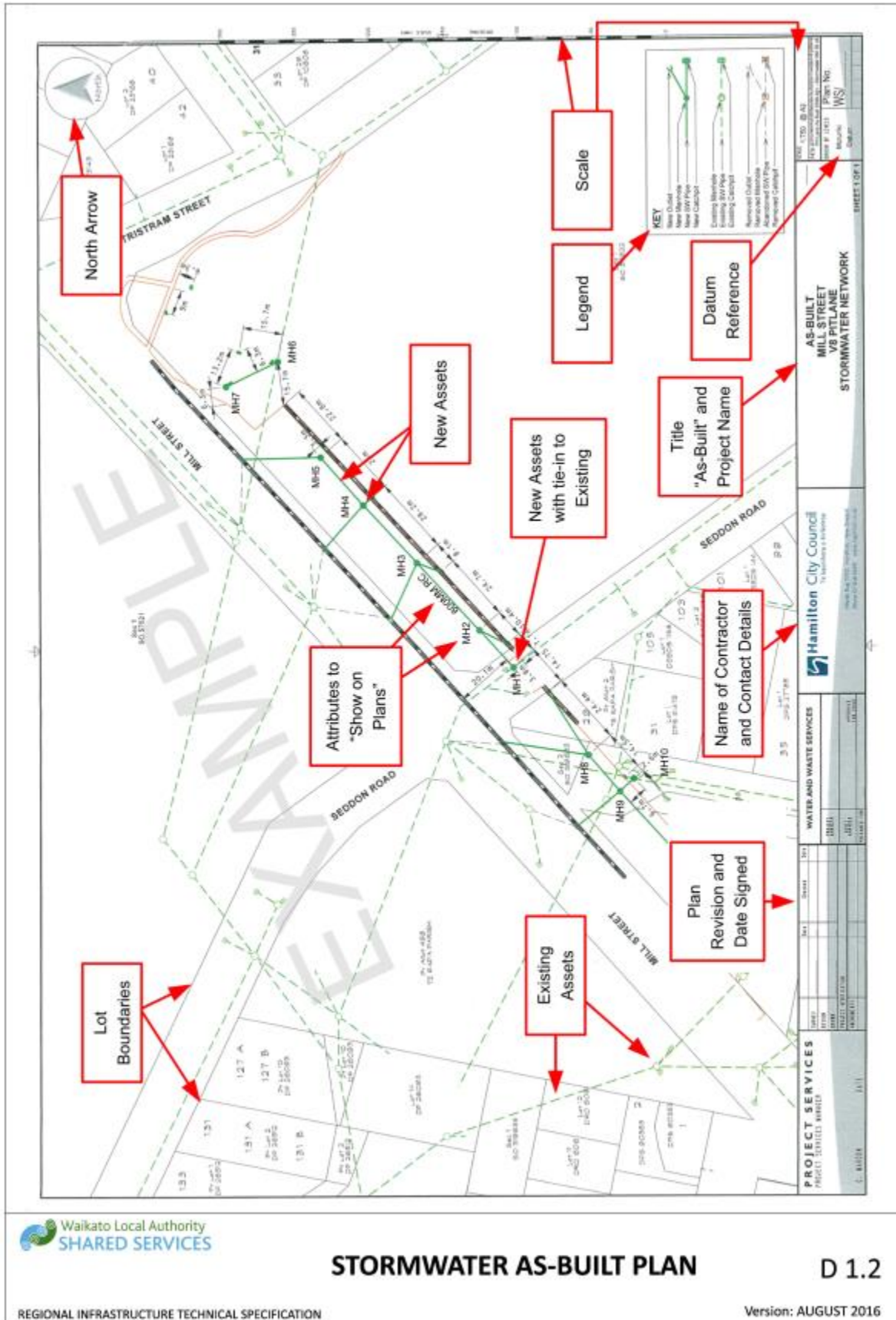

Drawing 1-2: Stormwater as-built plan

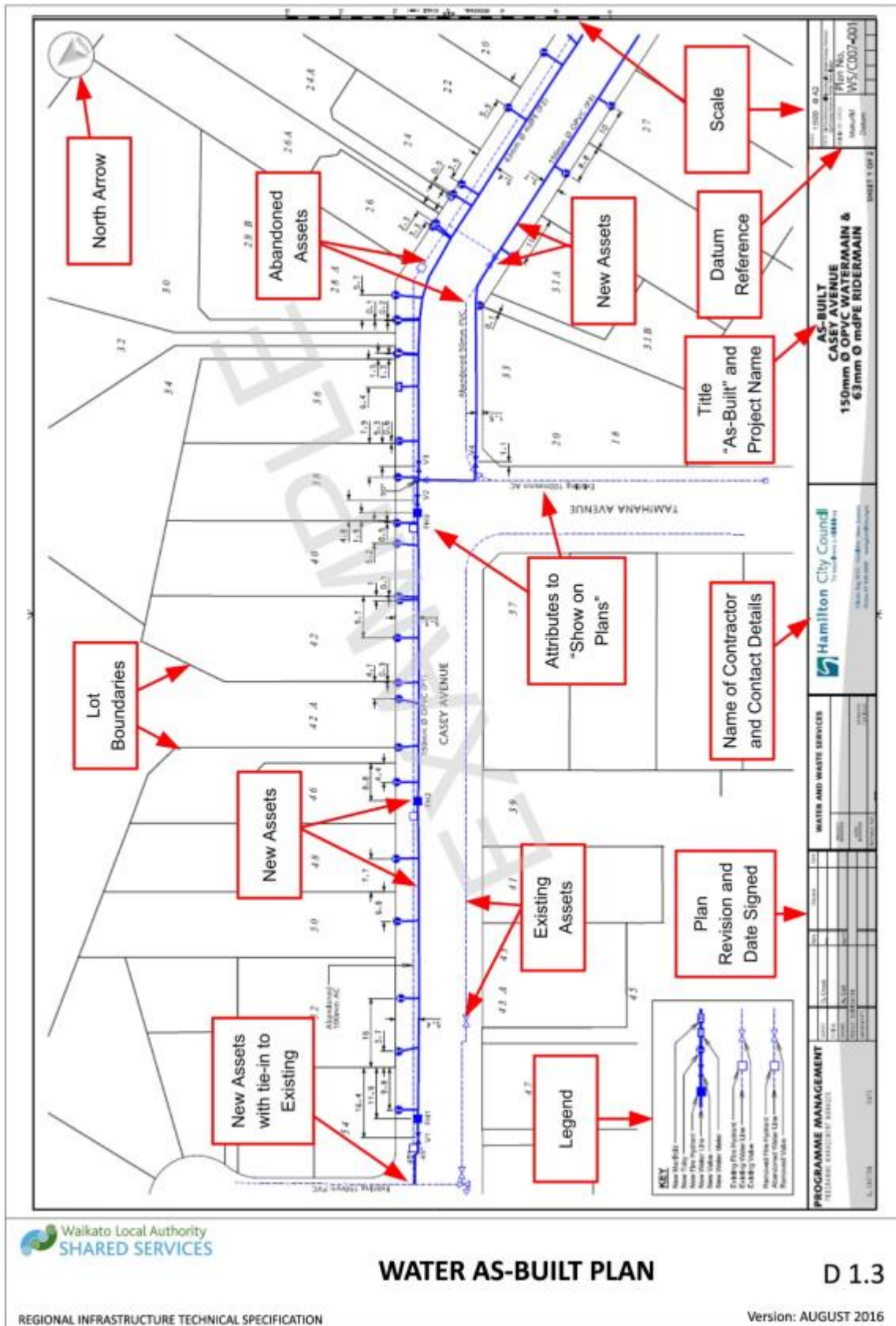

Drawing 1-3: Water as-built plan

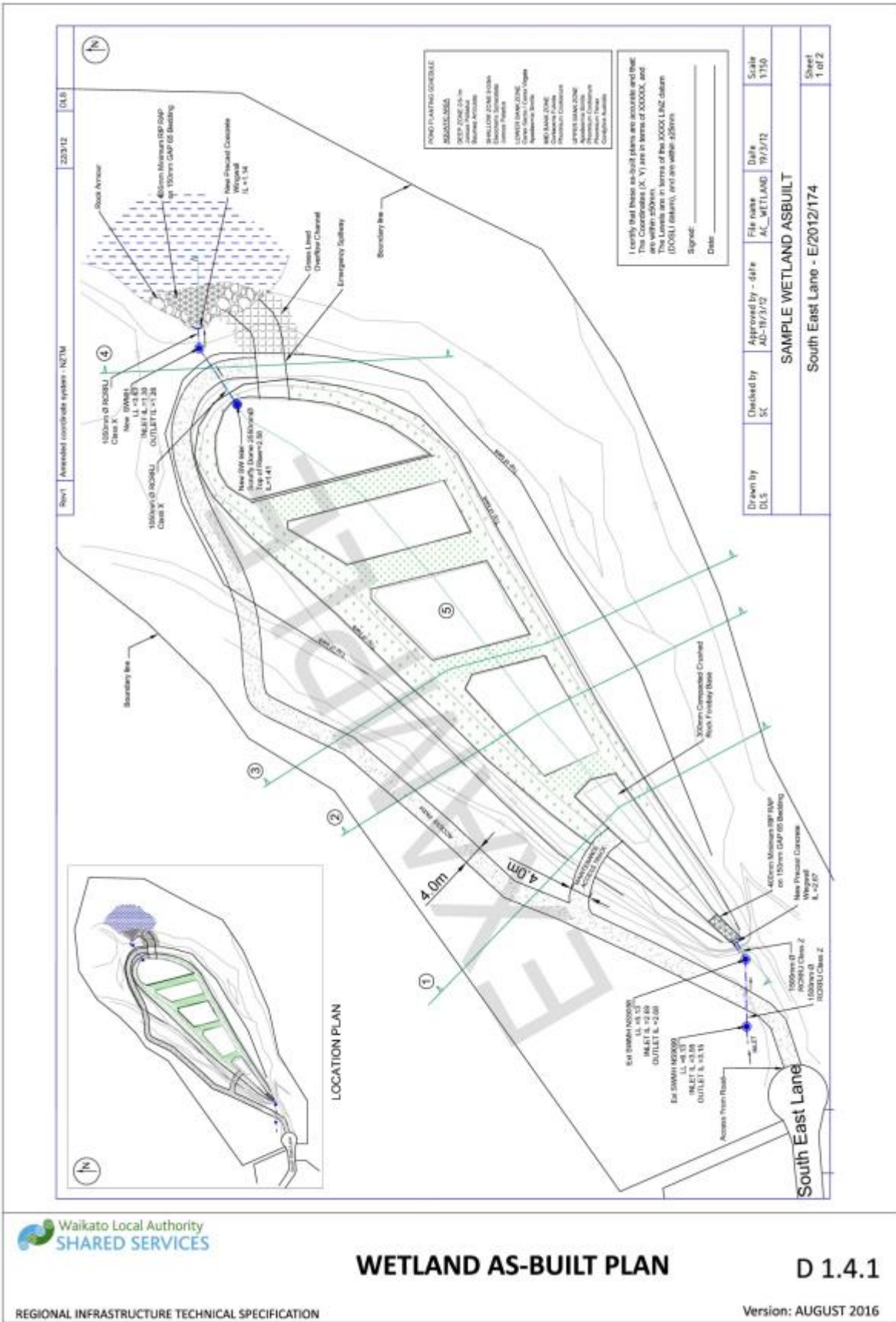

Drawing 1-4: Wetland as-built plan

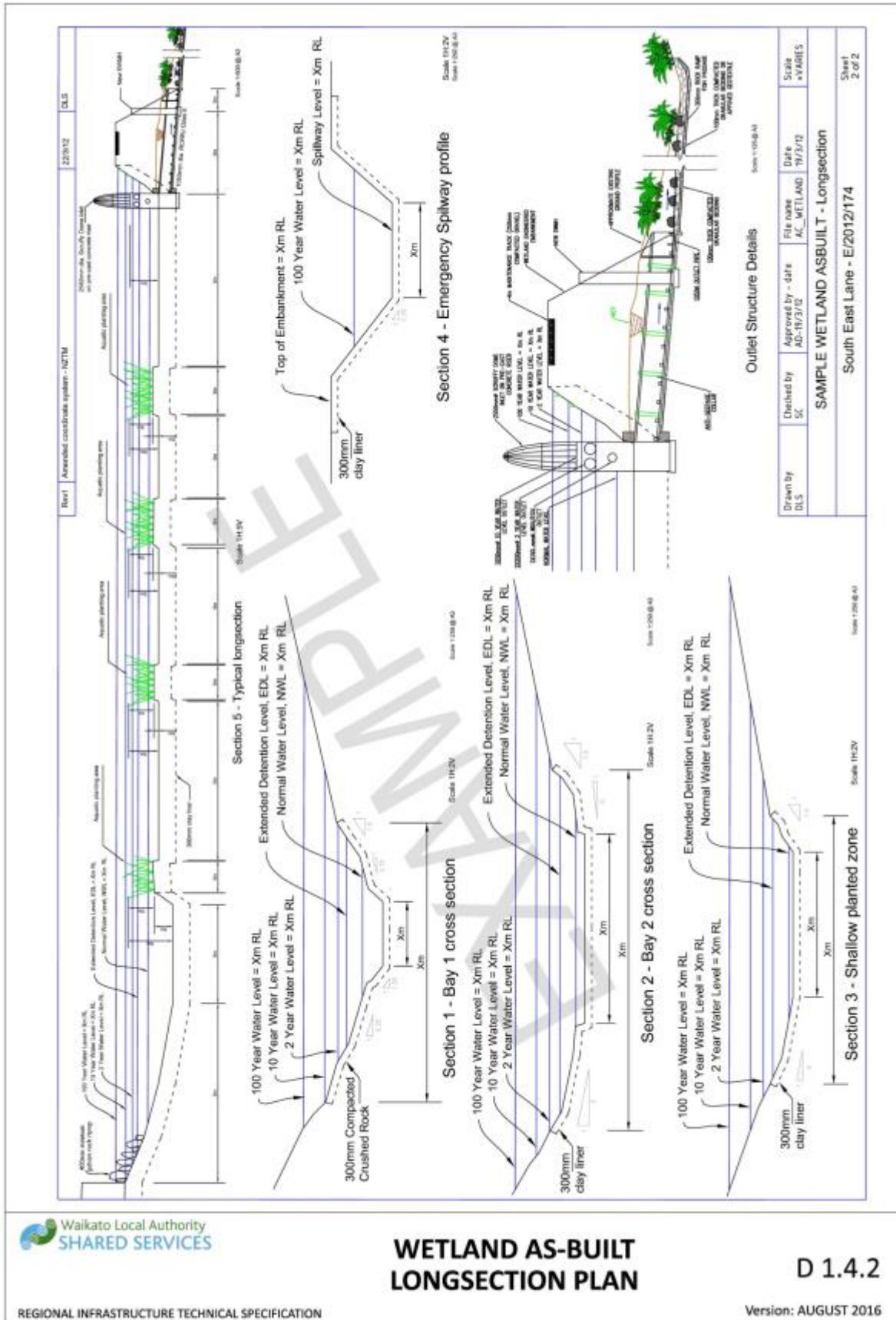

Drawing 1-5: Wetland as-built long section plan

APPENDIX 1C: THREE WATERS ASSET ATTRIBUTES

Table 1-12: Three Waters As-Built Data Templates

The following sets of electronic templates are to be completed as appropriate. They are available on the Co-Lab website.

WITHIN THIS DOCUMENT	CO-LAB WEBSITE AUTOMATIC DOWNLOAD LINK
Stormwater asset attributes	Stormwater pipes Stormwater management device (also available on the website)
Wastewater	Wastewater CCTV (also available on the website)
Water	Water Plants (available on the website)

Table 1-13: Stormwater Asset Attributes

ASSET COMPONENT TYPE	ASSET ATTRIBUTE REQUIRED	SHOW ON PLANS	DESCRIPTION OF ASSET ATTRIBUTE
Stormwater Inlet	Plan ID	Yes	Plan number used to identify as-built plan
	Downstream MH ID	Yes	
	Property ID	Yes	Either property number or legal description adjacent to manhole
	Street Name	Yes	If street name is not applicable use a property deposited plan (DP) number
	Street Type	Yes	Qualifier to street name e.g. Crescent, Road, Lane, etc.
	Location		Private property, roadway, berm, reserve
	Reduced Level	Yes	
	Structure Type	Yes	Plain end pipe, headwall, in-ground chamber, etc. Show structure location on plan
	Structure Material		PVC, concrete, timber, etc.
	Eastern Coordinate		
	Northern Coordinate		
	Service Status	Yes	'E' if an existing asset, 'A' if an abandoned/removed asset, 'N' if a new asset
	Asset Value		Refer Clause 1.9.6 of this section
	Install Date		Installation date
Comments		Any pertinent comments (particularly water table depth and soil conditions)	
Stormwater Pipeline (including culverts)	Plan ID	Yes	Plan number used to identify as-built plan
	Upstream MH ID	Yes	Use pipe-end ID if pipeline is simply blanked-off
	Downstream MH ID	Yes	Or ID of stormwater outlet structure
	Street Name	Yes	If street name is not applicable use a property deposited plan (DP) number
	Street Type	Yes	Qualifier to street name e.g. Crescent, Road, Lane, etc.
	Physical Location		Private property, roadway, berm, reserve, adjoining street
	Pipe Diameter	Yes	Nominal bore
	Pipe Length	Yes	Length upstream MH to downstream MH
	Pipe Material	Yes	Material and strength classification
	Joint Type		RRJ
	Invert Upstream	Level Yes	Pipe invert level

ASSET COMPONENT TYPE	ASSET ATTRIBUTE REQUIRED	SHOW ON PLANS	DESCRIPTION OF ASSET ATTRIBUTE
	Invert Level Downstream	Yes	Pipe invert level
	Secondary Flow Path	Yes	Show on as-built plans (easement required on private land). Not required on data sheet.
	Service Status	Yes	'E' if an existing asset, 'A' if an abandoned/ removed asset, 'N' if a new asset
	Asset Value		Refer Clause 1.9.6 of this section
	Install Date		Installation date
	Comments		Any pertinent comments (particularly water table depth and soil conditions) Identify culverts
Stormwater Service Connection	Plan ID	Yes	Plan number used to identify as-built plan
	Upstream MH ID	Yes	Use 'Pipe-End ID' if pipeline is simply blanked-off
	Downstream MH ID	Yes	Or ID of downstream asset
	Property ID	Yes	Either property number or legal description
	Street Name	Yes	If street name is not applicable use a property deposited plan (DP) number
	Street Type	Yes	Qualifier to street name e.g. Crescent, Road, Lane, etc.
	Service Type		Pipe drain, K & C connection
	Service Diameter	Pipe Yes	Nominal bore in millimetres
	Service Length	Pipe Yes	
	Service Material	Pipe Yes	Material and strength classification
	Invert Level at Private End	Yes	Pipe invert level
	Depth at Private End		Depth from ground level to invert level
	Eastern Coordinate Connection		Coordinate of customer end of service connection
	Northern Coordinate Connection		Coordinate of customer end of service connection
	Distance from left (LB) or right (RB) boundary	Yes	Distance to customer connection point relative to left-hand or right-hand boundary facing the property from the street
	Distance from front (FB) or back (BB) boundary	Yes	
	Service Status	Yes	'E' if an existing asset, 'A' if an abandoned/removed asset, 'N' if a new asset

ASSET COMPONENT TYPE	ASSET ATTRIBUTE REQUIRED	SHOW ON PLANS	DESCRIPTION OF ASSET ATTRIBUTE
	Asset Value		Refer Clause 1.9.6 of this section.
	Install Date		Installation date
	Comments		Any pertinent comments (particularly water table depth and soil conditions)
Stormwater Manhole	Plan ID	Yes	Plan number used to identify as-built plan
	MH ID	Yes	
	Property ID	Yes	Either property number or legal description adjacent to manhole
	Street Name	Yes	If street name is not applicable use a property deposited plan (DP) number
	Street Type	Yes	Qualifier to street name e.g. Crescent, Road, Lane, etc.
	Lid Level	Yes	Top edge and northern part of rim casting
	Invert Level	Yes	
	MH Diameter		Nominal Bore of MH risers
	Eastern Coordinate		Location as per lid level
	Northern Coordinate		Location as per lid level
	Service Status	Yes	'E' if an existing asset, 'A' if an abandoned/removed asset, 'N' if a new asset
	Asset Value		Refer Clause 1.9.6 of this section.
	Install Date		Installation date
	Comments		Any pertinent comments (particularly water table depth and soil conditions)
Stormwater Soakage Trench	Plan ID	Yes	Plan number used to identify as-built plan
	Street Name	Yes	If street name is not applicable use a property deposited plan (DP) number
	Street Type	Yes	Qualifier to street name e.g. Crescent, Road, Lane, etc.
	Location		Roadway, private, recreation reserve, etc.
	Trench Soakage Media	Yes	
	Length	Yes	
	Width	Yes	
	Depth	Yes	
	Volume	Yes	
	Ground Level		
	Invert Level		
	Eastern Coordinate End 1	–	
	Northern		

ASSET COMPONENT TYPE	ASSET ATTRIBUTE REQUIRED	SHOW ON PLANS	DESCRIPTION OF ASSET ATTRIBUTE
	Coordinate End 1	–	
	Eastern Coordinate End 2	–	Only one set of coordinates is required if the 'trench' is circular, i.e. a 'soakage hole'
	Northern Coordinate End 2	–	Only one set of coordinates is required if the 'trench' is circular, i.e. a 'soakage hole'
	Structure Type	Yes	Proprietary name, lined hole, perforated pipe, etc.
	Service Status	Yes	'E' if an existing asset, 'A' if an abandoned/removed asset, 'N' if a new asset
	Asset Value		Refer Clause 1.9.6 of this section
	Install Date		Installation date
	Comments		Any pertinent comments (particularly water table depth and soil conditions)
Stormwater Outlet	Plan ID	Yes	Plan number used to identify as-built plan
	Upstream MH ID	Yes	
	Property ID	Yes	Either property number or legal description adjacent to manhole
	Street Name	Yes	If street name is not applicable use a property deposited plan (DP) number
	Street Type	Yes	Qualifier to street name e.g. Crescent, Road, Lane, etc.
	Location	Yes	Private property, roadway, berm, reserve
	Structure Type	Yes	Plain end pipe, headwall, etc. Show structure location on plan
	Structure material		PVC, concrete, timber, etc.
	Discharges To		Name of receiving water body, e.g. Waikato River
	Ground Level		
	Eastern Coordinate		Location at point of stormwater discharge
	Northern Coordinate		Location at point of stormwater discharge
	Service Status	Yes	'E' if an existing asset, 'A' if an abandoned/removed asset, 'N' if a new asset
	Asset Value		Refer Clause 1.9.6 of this section.
	Install Date		Installation date
	Comments		Any pertinent comments (particularly water table depth and soil conditions)
Stormwater Catchpit	Plan ID	Yes	Plan number used to identify as-built plan
	Catchpit ID	Yes	Provide a catchpit ID to ensure correct association of tabulated information and plan
	Property ID	Yes	Either property number or legal description adjacent

ASSET COMPONENT TYPE	ASSET ATTRIBUTE REQUIRED	SHOW ON PLANS	DESCRIPTION OF ASSET ATTRIBUTE
			to manhole
	Street Name	Yes	If street name is not applicable use a property deposited plan (DP) number
	Street Type	Yes	Qualifier to street name e.g. Crescent, Road, Lane, etc.
	Catchpit Type	Yes	Footpath berm, single or double sump, vertical entry
	Catchpit Grate Level		
	Eastern Coordinate		Centre of catchpit grate
	Northern Coordinate		Centre of catchpit grate
	Asset Value		Refer Clause 1.9.6 of this section
	Install Date		Installation date
	Comments		Any pertinent comments (particularly water table depth and soil conditions)
Stormwater catchpit connection lead	Plan ID	Yes	Plan number used to identify as-built plan
	Catchpit ID	Yes	Identifier to associate pipeline with correct catchpit
	Downstream MH ID	Yes	Or ID of downstream asset
	Property ID	Yes	Either property number or legal description adjacent to manhole
	Street Name	Yes	If street name is not applicable use a property deposited plan (DP) number
	Street Type	Yes	Qualifier to street name e.g. Crescent, Road, Lane, etc.
	Connection Pipe Diameter		Nominal Bore of connection pipeline
	Connection Pipe Length	Yes	
	Connection Pipe Material		Material of connection pipeline
	Invert level Downstream End of Connection		RL of pipeline invert when catchpit connected to a manhole
	Asset Value		Refer Clause 1.9.6 of this section
	Install Date		Installation date
	Comments		Any pertinent comments (particularly water table depth and soil conditions)
Stormwater Open Channel	Plan ID	Yes	Plan number used to identify as-built plan
	Upstream Outlet ID	Yes	Define lengths of open channel as draining between structures or junctions with other water courses / drains

ASSET COMPONENT TYPE	ASSET ATTRIBUTE REQUIRED	SHOW ON PLANS	DESCRIPTION OF ASSET ATTRIBUTE
	Downstream Inlet ID	Yes	Define lengths of open channel as draining between structures or junctions with other water courses / drains
	Street Name	Yes	If street name is not applicable use a property deposited plan (DP) number
	Street Type	Yes	Qualifier to street name e.g. Crescent, Road, Lane, etc.
	Location	Yes	Private property, roadway, berm, reserve, adjoining street
	Channel Lining Material	Yes	
	Channel Length	Yes	Length upstream outlet to downstream inlet
	Channel Width	Yes	
	Average Depth		Formation depth, ground level to invert level
	Invert Level Upstream	Yes	
	Invert Level Downstream	Yes	
	Eastern Coordinate Upstream Inlet.	–	
	Northern Coordinate Upstream Inlet	–	
	Eastern Coordinate Downstream Outlet	–	
	Northern Coordinate Downstream Outlet	–	
	Asset Value		Refer Clause 1.9.6 of this section excluding land value, formation cost only
	Install Date		Installation date
	Comments		Any pertinent comments (particularly water table depth and soil conditions)
Stormwater Subsoil Drain	Plan ID	Yes	Plan number used to identify as-built plan
	Downstream MH ID	Yes	Or ID of discharge point for drain
	Street Name	Yes	If street name is not applicable use a property deposited plan (DP) number
	Street Type	Yes	Qualifier to street name e.g. Crescent, Road, Lane, etc.
	Location	Yes	Private property, roadway, berm, reserve, adjoining street
	Ownership	Yes	Public or private responsibility for the subsoil drain

ASSET COMPONENT TYPE	ASSET ATTRIBUTE REQUIRED	SHOW ON PLANS	DESCRIPTION OF ASSET ATTRIBUTE
	Pipe Diameter	Yes	Nominal bore in millimetres
	Pipe Length	Yes	Length upstream MH to downstream MH
	Pipe Material	Yes	PE, Earthenware, etc.
	Invert Level Upstream	Yes	
	Invert Level Downstream	Yes	
	Eastern Coordinate Upstream End	-	
	Northern Coordinate Upstream End	-	
	Eastern Coordinate Downstream Outlet	-	
	Northern Coordinate Downstream Outlet	-	
	Service Status	Yes	'E' if an existing asset, 'A' if an abandoned/removed asset, 'N' if a new asset
	Asset Value		Refer Clause 1.9.6 of this section
	Install Date		Installation date
	Comments		Any pertinent comments (particularly water table depth and soil conditions)
Stormwater Management Devices	Wetlands Ponds Raingardens Swales Overland flowpaths	Yes	Requirements are listed within the As built data template 'Stormwater Management Devices'. The requirements are numerous and in a different format to other datasheets, due to the technical nature of these devices, and the uses of the data for such requirements as modelling inputs and stormwater consent compliance.

Table 1-14: Wastewater Asset Attributes

ASSET COMPONENT TYPE	ASSET ATTRIBUTE REQUIRED	SHOW ON PLANS	DESCRIPTION OF ASSET ATTRIBUTE
Wastewater Pipeline	Plan ID	Yes	Plan number used to identify as-built plan
	Upstream MH ID	Yes	Use 'pipe-end ID' if pipeline is simply blanked-off
	Downstream MH ID	Yes	
	Street Name	Yes	If street name is not applicable use a property deposited plan (DP) number
	Street Type	Yes	Qualifier to street name e.g. Crescent, Road, Lane, etc.
	Physical Location		Private property, roadway, berm, reserve, adjoining street
	Pipe Diameter	Yes	Nominal bore
	Pipe Length	Yes	Length from upstream MH to downstream MH
	Pipe Material	Yes	Material and strength classification e.g. uPVC SN16
	Joint Type		e.g. RRJ
	Invert Upstream Level	Yes	Pipe invert level
	Invert Downstream Level	Yes	Pipe invert level
	Service Status	Yes	Abandoned or removed pipelines are required to be identified on as-built records. 'E' if an existing asset, 'A' if an abandoned/removed asset, 'N' if a new asset
	Asset Value		Refer Clause 1.9.6 of this section.
Install Date		Installation date	
Comments		Any pertinent comments (particularly water table depth and soil conditions)	
Wastewater service connection	Plan ID	Yes	Plan number used to identify as-built plan
	Upstream MH ID	Yes	Use pipe-end ID if pipeline is simply blanked-off
	Downstream MH ID	Yes	
	Property ID	Yes	Either property number or legal description
	Street Name	Yes	If street name is not applicable use a property deposited plan (DP) number
	Street Type	Yes	Qualifier to street name e.g. Crescent, Road, Lane, etc.
	Service Diameter	Pipe	Nominal bore
	Service Length	Pipe Yes	
	Service Material	Pipe	Material and strength classification
	Invert Level at	Yes	Pipe invert level

ASSET COMPONENT TYPE	ASSET ATTRIBUTE REQUIRED	SHOW ON PLANS	DESCRIPTION OF ASSET ATTRIBUTE
	Private End		
	Depth at Private End		Depth from ground level to Invert Level
	Eastern Coordinate End 1		Coordinate of upstream end of service connection
	Northern Coordinate End 1		Coordinate of upstream end of service connection
	Distance from left (LB) or right (RB) boundary	Yes	Left-hand or right-hand boundary facing the property from the street
	Distance from front (FB) or back (BB) boundary	Yes	
	Service Status	Yes	'E' if an existing asset, 'A' if an abandoned/removed asset, 'N' if a new asset
	Asset Value		Refer Clause 1.9.6 of this section.
	Install Date		Installation date
	Comments		Any pertinent comments (particularly water table depth and soil conditions)
Wastewater Manhole	Plan ID	Yes	Plan number used to identify as-built plan
	MH ID	Yes	
	Property ID	Yes	Either property number or legal description adjacent to manhole
	Street Name	Yes	If street name is not applicable use a property deposited plan (DP) number
	Street Type	Yes	Qualifier to street name e.g. Crescent, Road, Lane, etc.
	Lid Level	Yes	Top edge and northern part of rim casting
	Invert Level	Yes	Invert level of wetwell
	MH Diameter		Nominal Bore of MH risers
	Eastern Coordinate		Location as per lid level
	Northern Coordinate		Location as per lid level
	Service Status	Yes	Abandoned or removed pipelines are required to be identified on as-built records. Show "A" for abandoned pipes, "R" for removed pipes, otherwise leave blank 'E' if an existing asset, 'A' if an abandoned/removed asset, 'N' if a new asset
	Asset Value		Refer Clause 1.9.6 of this section.
	Install Date		Installation date
	Comments		Any pertinent comments (particularly water table depth and soil conditions)

ASSET COMPONENT TYPE	ASSET ATTRIBUTE REQUIRED	SHOW ON PLANS	DESCRIPTION OF ASSET ATTRIBUTE
Wastewater Pump Station			
Pump Station General	Plan ID	Yes	Plan number used to identify as-built plan
	Street name	Yes	If street name is not applicable, use a property deposited plan (DP) number
	Street type	Yes	Qualifier to street name, e.g. Crescent, Road, Lane, etc.
	Pump Station Lot Location	Yes	Show the pump station Lot boundary and surround lots and roads, including the accessway up to the Pump Station
	Install Date		Installation date
	Maximum Design Flow Rates		
	Design ADWF		ADWF – average dry weather flow
	Design PWWF		PWWF – peak wet weather flow
Pump Station Wet Well	Location	Yes	Show on a separate pump station site layout plan & cross-section plan at suitable scale
	Rising Main Discharge Point	Yes	Manhole ID
	Rising Main Diameter	Yes	The rising main should appear as an item on the schedule of wastewater pipelines
	Overflow Discharges To	Yes	Refer to the ID of the overflow pipe which should appear as an item on the schedule of wastewater pipelines
	Overflow level	Yes	RL at which overflow begins
	Length	Yes	Internal length dimension of wet well
	Width	Yes	Internal width dimension of wet well
	Diameter	Yes	Internal diameter of wet well (circular wet wells)
	Floor Elevation	Yes	Invert level of chamber
	Ground Elevation	Yes	RL of wet well access covers
	Inlet Diameter	Yes	Repeat for each inlet
	Inlet Elevation	Yes	Repeat for each inlet
	Asset Value		Refer Clause 1.9.6 of this section.
	Install Date		Installation date
	Comments		Any pertinent comments (particularly water table depth and soil conditions)
Storage Chamber	Location	Yes	Show on a separate pump station site layout plan & cross section plan at suitable scale
	Length	Yes	Internal length dimension of chamber
	Width	Yes	Internal width dimension of chamber
	Diameter	Yes	Internal diameter of chamber (circular chambers)

ASSET COMPONENT TYPE	ASSET ATTRIBUTE REQUIRED	SHOW ON PLANS	DESCRIPTION OF ASSET ATTRIBUTE
	Floor Elevation	Yes	Invert level of chamber
	Ground Elevation	Yes	RL of storage chamber access covers
	Inlet Diameter	Yes	Repeat for each inlet
	Inlet Elevation	Yes	Repeat for each inlet
	Service Status	Yes	'E' if an existing asset, 'A' if an abandoned/removed asset, 'N' if a new asset
	Asset Value		Refer Clause 1.9.6 of this section.
	Install Date		Installation date
	Comments		Any pertinent comments (particularly water table depth and soil conditions)
Valve Chamber	Location	Yes	Show on a separate pump station site layout plan & cross section plan at suitable scale
	Depth	Yes	
	Water Supply Backflow Prevention Device		Make & Model
	Rising Main Check Valve		Nominal Bore - Repeat for each valve
	Rising Main Isolation Valve		Nominal Bore - Repeat for each valve
	Service Status	Yes	'E' if an existing asset, 'A' if an abandoned/removed asset, 'N' if a new asset
	Asset Value		Refer Clause 1.9.6 of this section - Repeat for each valve
	Install Date		Installation date
	Comments		Any pertinent comments
Bio Filter	Location	Yes	Show on a pump station site layout plan
	Length	Yes	Internal length dimension of chamber
	Width	Yes	Internal width dimension of chamber
	Inlet Diameter	Yes	Repeat for each inlet
	Inlet Elevation	Yes	Repeat for each inlet
	Asset Value		Refer Clause 1.9.6 of this section
	Install Date		Installation date
	Comments		Any pertinent comments relating to the type of bio filter media used
Magflow Meter	Location	Yes	Show on a pump station site layout plan
	Manufacturer		
	Model Number		
	Magflow Serial number		
	Asset Value		Refer Clause 1.9.6 of this section.
	Install Date		Installation date

ASSET COMPONENT TYPE	ASSET ATTRIBUTE REQUIRED	SHOW ON PLANS	DESCRIPTION OF ASSET ATTRIBUTE
Pumps	Manufacturer		
(repeat for each pump)	Model Number		
	Performance Curve ID		
	Motor Serial Number		
	Motor Current Rating		Nameplate current in amps
	Motor Power Rating		Nameplate power rating in kW
	Asset Value		Refer Clause 2.4.3 - Repeat for each pump
	Comments		Any pertinent comments (particularly water table depth and soil conditions)
Level Controls	Manufacturer		
	Model ID		
	Backup Battery Type		
	Start Level		Repeat for each pump
	Stop Level		Repeat for each pump
	High Alarm Level		
	Low Alarm Level		
	Overflow Alarm Level		
	Asset Value		Refer Clause 1.9.6 of this section - lump sum for whole level control system
	Comments		Any pertinent comments
Electrical Cabinet	Location	Yes	Show on a pump station site layout plan
	Pump Overload Setting		Repeat for each pump
	Pump Contactor Type		Repeat for each pump
	Pump Starter Type		Repeat for each pump
	Service Status	Yes	'E' if an existing asset, 'A' if an abandoned/removed asset, 'N' if a new asset
	Asset Value		Refer Clause 1.9.6 of this section - lump sum for electrical cabinet
	Install Date		Installation date
	Comments		Any pertinent comments
Telemetry	RT Brand		
	RT Model		

ASSET COMPONENT TYPE	ASSET ATTRIBUTE REQUIRED	SHOW ON PLANS	DESCRIPTION OF ASSET ATTRIBUTE
	Aerial Type		
	Micrologix 110 Allen Bradley Module Model		
	Asset Value		Refer Clause 1.9.6 of this section - lump sum for telemetry
	Comments		Any pertinent comments (particularly water table depth and soil conditions)

Table 1-15: Water Asset Attributes

ASSET COMPONENT TYPE	ASSET ATTRIBUTE REQUIRED	SHOW ON PLANS	DESCRIPTION OF ASSET ATTRIBUTE
Water Pipeline	Plan ID	Yes	Plan number used to identify as-built plan
	Pipe ID	Yes	Use a pipe numbering system to link individual pipes and related information such as length, diameter, material, coordinates, etc. Pipe ends occur at pipe intersections and when pipe diameter changes
	Pipe Diameter	Yes	Nominal bore
	Pipe Length	Yes	Show pipeline location on the plan Show dimensions to adjacent boundaries
	Laying Depth	Yes	Average depth below ground level to top of pipe
	Pipe Material	Yes	Material and strength classification
	Joint Type		RRJ, gibault, welded etc.
	Service Status	Yes	Abandoned or removed pipelines are required to be identified on as-built records. 'E' if an existing asset, 'A' if an abandoned/removed asset, 'N' if a new asset
	Asset Value		Refer Clause 1.9.6 of this section – pipe, pipe bends, and tees and associated fittings; show valves and hydrants separately
	Install Date		Installation Date
	Comments		Any pertinent comments (particularly water table depth and soil conditions)
Water Service Connection	Plan ID	Yes	Plan number used to identify as-built plan
	Pipe ID	Yes	Use a pipe numbering system to identify individual pipes if Property ID or Street numbering is not adequate.
	Property ID	Yes	Either property number or legal description
	Street Name	Yes	If street name is not applicable use a property deposited plan (DP) number
	Street Type	Yes	Qualifier to street name e.g. Crescent, Road, Lane, etc.
	Service Pipe Diameter		Nominal bore
	Service Pipe Length	Yes	Show pipeline location on the plan
	Service Pipe Material		Material and strength classification
	Eastern Coordinate		Coordinate of customer end of service pipeline i.e. at the service valve or toby
	Northern Coordinate		Coordinate of customer end of service pipeline i.e. at the service valve or toby
	Toby Lid Level		From middle of toby lid
	Distance from left (LB) or right (RB) boundary	Yes	Distance to customer connection point relative to left-hand or right-hand boundary facing the property from the street
	Meter Installed	Yes	Yes / no response (if yes complete a council ' Water Meter' form for each installation)
	Install Date		Installation Date
Service Status	Yes	'E' if an existing asset, 'A' if an abandoned/removed asset, 'N' if a new asset	

ASSET COMPONENT TYPE	ASSET ATTRIBUTE REQUIRED	SHOW ON PLANS	DESCRIPTION OF ASSET ATTRIBUTE
	Asset Value		Refer Clause 1.9.6 of this section – include all components from tapping band to toby
	Comments		Any pertinent comments
Water Valves	Plan ID	Yes	Plan number used to identify as-built plan
	Pipe ID	Yes	Use a pipe numbering system to identify individual pipes if Property ID or Street numbering is not adequate
	Property ID	Yes	Either property number or legal description
	Street Name	Yes	If street name is not applicable use a property deposited plan (DP) number
	Street Type	Yes	Qualifier to street name e.g. Crescent, Road, Lane, etc.
	Valve Size		Nominal bore in millimetres
	Valve Manufacturer		
	Location	Yes	Roadway, berm
	Eastern Coordinate		Coordinate of valve
	Northern Coordinate		Coordinate of valve
	Valve Level		From middle of Valve Lid
	Service Status	Yes	'E' if an existing asset, 'A' if an abandoned/removed asset, 'C' if a new asset
	Asset Value		Refer Clause 1.9.6 of this section – include all fittings such as gibaults, flanged spigots, surface box, marker post, etc.
	Install Date		Installation Date
	Comments		Any pertinent comments such as 'attached to anchor block'
Water Valve Chamber	Plan ID	Yes	Plan number used to identify as-built plan
	Property ID	Yes	Either property number or legal description
	Street Name	Yes	If street name is not applicable use a property deposited plan (DP) number
	Street Type	Yes	Qualifier to street name e.g. Crescent, Road, Lane, etc.
	Chamber Size		Dimensions of chamber in millimetres
	Chamber Volume		Volume of chamber in cubic metres
	Service Status	Yes	'E' if an existing asset, 'A' if an abandoned/removed asset, 'N' if a new asset
	Asset Value		Refer Clause 1.9.6 of this section
	Install Date		Installation Date
	Comments		Any pertinent comments
Hydrants	Plan ID	Yes	Plan number used to identify as-built plan
	Pipe ID	Yes	Use a pipe numbering system to identify individual pipes if Property ID or Street numbering is not adequate
	Property ID	Yes	Either property number or legal description
	Street Name	Yes	If street name is not applicable use a property deposited plan (DP) number
	Street Type	Yes	Qualifier to street name e.g. Crescent, Road, Lane, etc.
	Hydrant Size		Nominal bore in millimetres

ASSET COMPONENT TYPE	ASSET ATTRIBUTE REQUIRED	SHOW ON PLANS	DESCRIPTION OF ASSET ATTRIBUTE
	Hydrant Manufacturer		
	Location	Yes	Roadway, berm
	Eastern coordinate		Coordinate of hydrant
	Northern coordinate		Coordinate of hydrant
	Hydrant Level		From middle of Hydrant Lid
	Service Status	Yes	'E' if an existing asset, 'A' if an abandoned/removed asset, 'N' if a new asset
	Asset Value		Refer Clause 1.9.6 of this section – include all fittings such as gibaults, flanged spigots, surface box, marker post, etc.
	Install Date		Installation Date
	Comments		Any pertinent comments

APPENDIX 1D : LANDSCAPE (PARKS & FACILITIES) ASSET DATA FORMS

Table 1-16: Landscape Asset Data Forms

WITHIN THIS DOCUMENT	LASS WEBSITE LINK
New assets	New assets
Assets removed	Assets removed
As-built drawings	As-built drawings

ASSET DATA FORMS – NEW ASSETS

Regional Infrastructure Technical Specification

July 2017

Parks & Facilities - New Assets

Community: _____
 Reserve/Park: _____
 Location: _____
 Property No: _____

Project No: _____
 Project Account Code: _____
 Project Manager: _____
 Surveyor/Contractor: _____
 Photo file path: _____

Total Cost: _____
 Internal Ref: _____
 Date: _____
 Page: _____ of _____

New Asset Details:

Item	Description/location	Qty	Cost	Material			GPS coordinates	GPS coordinates	Photo no.

Parks & Facilities (Other Use Only)

Entered into Asset Register Date: _____
 Requestor Notified Date: _____
 P & F notified Date: _____
 Date Received P&R: _____
 Finance notified Date: _____

ASSET DATA FORMS – ASSETS REMOVED

Regional Infrastructure Technical Specification

July 2017

Parks & Facilities - Assets Removed

Community: _____
 Reserve/Park: _____
 Location: _____
 Property No: _____

Project No: _____
 Project Manager: _____
 Surveyor/Contractor: _____
 Photo file path: _____

Total Cost: _____
 Internal Ref: _____
 Date: _____
 Page: _____ of _____

Removed Asset Details:

Item	Description	Unit	Qty.	Material	GPS coordinate	GPS coordinate	Photo No.

Parks & Facilities Office Use Only

<input type="checkbox"/> Entered into Asset Finda/SPM	Date: _____	<input type="checkbox"/> Requester Notified	Date: _____	<input type="checkbox"/> P & F notified	Date: _____	<input type="checkbox"/> Finance notified	Date: _____	Date Received P&F: _____
---	-------------	---	-------------	---	-------------	---	-------------	--------------------------

ASSET DATA FORMS – AS BUILT DRAWINGS

Parks & Facilities - As-built Drawing

Regional Infrastructure Technical Specification

July 2017

The Contractor shall prepare and submit to the Engineer, copies of as-built information. All information to be of good quality and accurately titled, numbered, cross-referenced, and dated.

Record all positions of installed components as the works progresses for inclusion in as-built drawings:

Community: _____	Project No: _____	Total Cost: _____
Reserve/Park: _____	Project Manager: _____	Internal Ref: _____
Location: _____	Surveyor/Contractor: _____	Date: _____
Property No: _____		Page: _____ of _____

Parks & Facilities Office Use Only			Date Received P&R: _____
<input type="checkbox"/> Entered into BizAsset Date: _____	<input type="checkbox"/> Requestor Notified Date: _____	<input type="checkbox"/> Facilities notified Date: _____	<input type="checkbox"/> Finance notified Date: _____

Return To: Asset Information Officer

10

2 EARTHWORKS AND GEOTECHNICAL REQUIREMENTS

2.1	Introduction.....	72
2.1.1	Objectives.....	72
2.1.2	References and Abbreviations.....	72
2.1.3	Waikato Regional Council Requirements.....	73
2.1.4	Council Requirements.....	73
2.1.5	Heritage New Zealand.....	73
2.1.6	Geotechnical Requirements.....	74
2.2	Design.....	74
2.2.1	Land Contamination.....	74
2.2.2	Ground Investigation Methods.....	74
2.2.3	Erosion, Sediment and Dust Control.....	75
2.2.4	Geotechnical Assessment Report.....	75
2.3	Construction and Final Documentation.....	77
2.3.1	Construction.....	77
2.3.2	Dust Management.....	77
2.3.3	Erosion and Sediment Control Maintenance.....	78
2.3.4	Final Documentation.....	78
2.3.5	Resource Consents.....	78

LIST OF APPENDICES

Appendix 2A: Schedule 2A (NZS 4404:2010) Statement of Professional Opinion on Suitability of Land for Building Consent.....	79
---	----

LIST OF TABLES

Table 2-1: Standards, legislation and guidelines referenced.....	72
--	----

LIST OF FIGURES

No table of figures entries found.

LIST OF DRAWINGS

No table of figures entries found.

LIST OF EQUATIONS

No table of figures entries found.

2.1 INTRODUCTION

Participating Councils have chosen to adopt the geotechnical requirements of NZS 4404 : 2010 and this section shall be read in conjunction with NZS 4404. Any specific requirements relating to geotechnical assessments, testing and earthworks which are to be carried out within the boundaries of the participating councils are referenced here.

2.1.1 Objectives

The objective of this section is to set out some, but not necessarily all, of the matters which need to be considered in the planning and construction of a land development project.

2.1.2 References and Abbreviations

2.1.2.1 References

Details of standards, legislation and guidelines referenced in this section are as follows:

Table 2-1: Standards, legislation and guidelines referenced

STANDARD/LEGISLATION	TITLE
	Health and Safety at Work Act 2015
	Resource Management Act 1991 Resource Legislation Amendment Act 2017
ISO 31000:2009	Risk Management – Principles and Guidelines
NZS 4404:2010	Land Development and Subdivision Infrastructure
NZS 4431:1989	Code of practice for earth fill for residential development
Ministry of Business, Innovation and Employment	Building Code B1 Structure
Ministry of Business, Innovation and Employment/ NZ Geotechnical Society	Earthquake Geotechnical Engineering Practice Series
Ministry for Environment (MfE)	Contaminated Land Management Guidelines No. 1, Reporting on Contaminated Sites in New Zealand, Revised 2011); Hazardous Activities and Industries List (HAIL), Oct 2011 Good Practice Guide for Assessing and Managing Dust
New Zealand Geotechnical Society	Field Description of Soil and Rock, Guideline for the Field Classification and Description of Soil and Rock for Engineering Purposes, Dec 2005 New Zealand Ground Investigation Specification, Volumes 0, 1, 2 & 3
National Environment Standard (NES)	Resource Management (National Environmental Standard for Assessing and Managing Contaminants in Soil to Protect Human Health) Regulations 2011
Waikato Regional Council	Guidelines, as follows: <ul style="list-style-type: none"> Erosion and Sediment Control – Guidelines for Soil Disturbing Activities Erosion and Sediment Control Plan and Preparation Guideline

STANDARD/LEGISLATION	TITLE
	<ul style="list-style-type: none"> • Winter Works Application Preparation Guideline • Pre-construction meeting checklist • AS-built Certification Sheets

2.1.2.2 Abbreviations

IQP = Independently Qualified Person

HAIL = Hazardous Activities and Industries List

NES = National Environmental Standard

EPO = Environmental Protection Overlay

WRC = Waikato Regional Council

2.1.3 Waikato Regional Council Requirements

The Waikato Regional Council (WRC) plays a significant role in the management of earthworks and the supporting sediment control management systems.

Reference shall be given to the WRC guidelines listed in 2.1.2.1 above:

2.1.3.1 WRC Consents

Resource Consents from WRC will typically be required for the following:

- a) Works within a high risk erosion area
- b) Placement of structures in or adjacent to a bed in a waterway (e.g. outfalls, culverts, bridges, dams)
- c) Earthworks exceeding permitted activity
- d) The permanent diversion of natural water as a consequence of the development
- e) The discharge of stormwater into natural waterways
- f) The discharge of contaminants during construction work
- g) The diversion of natural water during construction work
- h) Large scale groundwater takes (dewatering) during construction work
- i) Tracking and vegetation removal during construction

2.1.4 Council Requirements

Consents for earthworks may be required from the Council - refer to the relevant District Plan for requirements. Dust mitigation is also a requirement of the District Plan.

In addition to subdivision resource consents from the Council, the following additional consents may also be required:

- a) Working within 5m of a waterway in an EPO layer
- b) Earth removal works and Vegetation removal
- c) Works within a high risk erosion area

2.1.5 Heritage New Zealand

Some sites may require consent from Heritage New Zealand.

2.1.6 Geotechnical Requirements

The Developer shall appoint a geo-professional to carry out functions as described in NZS 4404 Section 2.2.4. An IQP shall carry out an evaluation as required on other hazards.

Seismic and liquefaction hazards should also be addressed in accordance with MBIE's [Earthquake Geotechnical Engineering Practice Series](#).

2.2 DESIGN

The design process for geotechnical assessments and reports is as per NZS 4404 Section 2.3 with the following additions.

Reference shall be made to the Health and Safety at Work Act 2015 to ensure safety in design.

2.2.1 Land Contamination

The Waikato Regional and participating Councils maintain registers of sites that have been used for industrial activities which have the potential to cause land contamination. If the site is listed in one of these registers, or if signs of potential contamination are observed, the developer shall engage a suitably qualified professional to investigate contamination potential and required remedial measures as set out in the National Environmental Standard for Assessing and Managing Contaminants in Soil to Protect Human Health (NES). Early liaison with the Council contaminated land/environmental officers and staff is highly recommended in these circumstances.

It should be noted that such registers are not fully comprehensive and that developers should also make their own enquires as to past site uses. Potentially contaminative hazardous activities are listed in the Ministry of Environment 'HAIL' list.

If contamination is present on site then supervision and sampling and testing of soil and groundwater must be undertaken as set out in the NES. The assessment report shall detail the contamination and include a remediation action plan. The plan shall then be prepared and submitted to the relevant Council and Regional Council with the geotechnical assessment report.

2.2.2 Ground Investigation Methods

Reference shall be made to the following publications, as appropriate:

- NZS4404 Land Development and Subdivision Infrastructure, Clause 2.2.4
- NZS4431 Code of practice for earth fill for residential development
- NZ Geological Society – NZ Ground Investigation Specification
- MBIE – Building Code B1 Structure
- MBIE/NZGS - Earthquake Geotechnical Engineering Practice Series

2.2.3 Erosion, Sediment and Dust Control

2.2.3.1 Erosion and Sediment Control

Section 2.3.7 of NZS 4404 shall be read in conjunction with Waikato Regional Council's guidelines. Where ambiguity exists between documents Waikato Regional Council requirements shall take precedence.

2.2.3.2 Dust Control

Reference should be made to MfE's Good Practice Guide for Assessing and Managing Dust.

2.2.4 Geotechnical Assessment Report

A geotechnical assessment report shall be used to inform land use/subdivision layout and infrastructure design. The report shall be submitted to Council for approval prior to any earthworks taking place on the site.

The report shall consider, and as appropriate include, but not be limited to:

- a) A brief description of the site and its geology.
- b) Ground water levels, soil classifications and permeability.
- c) WRC and council's resource consent requirements.
- d) Preliminary site evaluation and findings.
- e) Evaluation of the foundation design parameters for building development, road and infrastructure design.
- f) Recommendations regarding the stability and accessibility to the building platform.
- g) Identification of the existence and extent of any previous filling activities on the site, and comment on the quality and suitability of such fills for development purposes.
- h) Evaluation of earthworks requirements in terms of area, volume, earth working methods, disposal of unwanted excavated material and specification for earthworks control, dust and silt management.
- i) Description of the type and methodology of fill to be used on the site. This shall include the source of the material, what testing has been carried out to prove that it is fit for design purpose, details of the compaction methodology and acceptance criteria, the end product specification, frequency of testing and site supervision requirements.
- j) Descriptions of any specific requirements regarding cuttings and embankments.
- k) Identification of any work necessary to manage the risk of geotechnical issues during the construction process i.e. temporary stability of excavations, groundwater control, fills and haul roads.
- l) If contamination of the site is found provide a detailed assessment of the contamination and recommend a remedial action plan.
- m) Erosion and Sediment Control Plan as per WRC guidelines.
- n) Identification and remedial recommendations for any natural hazards such as potential flooding, erosion, seismic, liquefaction and other either within the site or on neighbouring land. The assessment of natural hazards shall follow a risk based approach in accordance with ISO 31000:2009.

- o) Recommendations for site inspection levels and testing to be undertaken during construction to ensure the compaction of the material meets the earthworks specification.
- p) The geotechnical assessment report may require peer review, refer to NZS 4404 Section 2.3.2(g).

2.2.4.1 **Specification for Material, Placement and Compaction**

Fill Material

The report must state the source of the material, whether it is to be imported or sourced on site.

A description of this material in engineering terms must be given and be in accordance with the NZ Geotechnical Society publication, Field Description of Soil and Rock, Guideline for the Field Classification and Description of Soil and Rock for Engineering Purposes.

The report must state what testing has been undertaken on the source material to prove it is fit for the design purpose. This must include the type of test, what testing standards the testing has been carried out to, the number of tests undertaken, and the test results.

This testing may consist of, but not be limited to:

- a) NZ Standard Compaction Testing
- b) Shear Vane Testing
- c) Moisture Content Determination
- d) Plasticity Index Testing
- e) Particle Size Distribution
- f) California Bearing Ratio (CBR) Tests

Details of any under fill drainage and geosynthetics used in the design and plan showing where these are to be used, the type of geosynthetics and the function of the geosynthetic must be included.

2.2.4.2 **Compaction Criteria and Methodology**

Refer to NZS 4431 for the standard of compaction and method of determination.

Details of the compaction methodology to be adopted for the placement of fill must be presented together with the compaction acceptance criteria proposed for the works.

The acceptance criteria may be based on any combination of the following:

- a) A target percentage of the maximum dry density of the compacted material
- b) A range of suitable moisture contents of the material
- c) A maximum air voids of the material
- d) A maximum and minimum shear strength of the material

The basis upon which the chosen criteria are selected must be presented in the Geotechnical Assessment Report.

2.2.4.3 End Product Specification

Where an end product specification is required, the desired compaction criteria of the placed and compacted fill are specified and the earthworks contractor is free to choose whatever method of compaction they wish to achieve the targets specified.

2.2.4.4 Frequency of Tests

During the earthworks, soil tests need to be undertaken on the placed fill to ensure the necessary degree of compaction is being achieved. The methods of testing and frequency of tests shall be specified and included in the Fill Design Report.

2.2.4.5 Cuttings and Embankments

For cuttings and embankments formed as part of the earthworks, details of analytical methods used to determine slope stability are to be included. As part of this, the engineering properties and relevant ground investigation information is required.

As these earthwork features can affect the groundwater and surface run off, or need drainage measures to ensure stability, details of the drainage must be included.

If embankments form part of the proposed site works, settlement calculations must be included and justified from ground investigation data.

Details of any special measures to analyse slope or control settlements shall be included.

2.2.4.6 Topsoil

Top soiled surfaces shall be between 150–300mm consolidated depth, and shall consist of the outermost layer of natural soil with the highest concentration of organic matter and microorganisms, and generally be free of vegetation, large clumps, excessive and large stones, and be suitable for easy spreading in an even layer.

This topsoiling should endeavour to mimic the pre-existing conditions.

2.3 CONSTRUCTION AND FINAL DOCUMENTATION

2.3.1 Construction

During construction, site inspection and or testing shall be undertaken by a suitability qualified geo-professional with the requirements outlined in the geotechnical assessment report.

If any archaeological site or waahi tapu is discovered or disturbed during the works, Iwi and the Council shall be notified immediately

2.3.2 Dust Management

Reference should be made to MfE's Good Practice Guide for Assessing and Managing Dust.

During dry weather, where there is more than 400 m² of bare soil exposed on a development, one or more of the measures below is to be employed to reduce wind erosion and the amount of airborne dust emanating from the site:

- daily watering with hose and sprinkler for smaller areas;
- daily watering with spray equipped water truck for larger areas
- mulching with straw for long term dust control;
- hydromulching and hydroseeding for permanent control

2.3.3 Erosion and Sediment Control Maintenance

Maintenance of any erosion and sediment control devices shall be carried out as detailed in the approved Erosion and Sediment Control Plan.

2.3.4 Final Documentation

2.3.4.1 Geotechnical Completion Report

Where excavation or filling has been carried out, a plan (with before/after contours not exceeding 1m intervals) and a geotechnical completion report shall be submitted by the geotechnical engineer engaged by the developer as per NZS 4404 Section 2.6 prior to the final inspection of the development. The report shall be accompanied by a statement of professional opinion on the suitability of land for building construction (NZS 4404 Schedule 2A – see **Error! Reference source not found.**). If a development contains more than 10 lots, a matrix of geotechnical recommendations for each new lot should be attached to Schedule 2A.

2.3.4.2 Contaminated Site Validation Report

When earthworks have been undertaken on a potentially contaminated sites or a site known to be contaminated, a Site Validation Report shall be prepared.

As a minimum this must contain the data and all test results listed in the MfE Contaminated Land Management Guideline No 1.

A post construction Management and Monitoring Plan will form part of the Site Verification Report that is required on completion of any remedial works undertaken.

2.3.5 Resource Consents

The Developer is responsible for completing any requirements under any Resource Consents that have been issued for the development.

APPENDIX 2A: SCHEDULE 2A (NZS 4404:2010) STATEMENT OF PROFESSIONAL OPINION ON SUITABILITY OF LAND FOR BUILDING CONSENT

Development:

Developer:

Location:

I, _____ of _____
 (Full name) _____

 (Name and address of firm)

Hereby confirm that:

1. I am a geo-professional as defined in **Clause 1.3.3 of Section 1 (General Information) of the Regional Infrastructure Technical Specification (RITS)** and was retained by the developer as the geo-professional on the above development.

2. The extent of my preliminary investigations are described in my Report(s):
Number(s): _____ **Date:** _____

and the conclusions and recommendations of that/those document(s) have been re-evaluated in the preparation of this report.

3. The extent of my inspections during construction, and the results of all tests and/or re-evaluations carried out are as described in my geotechnical completion report:
Number: _____ **Date:** _____

4. In my professional opinion, not to be construed as a guarantee, I consider that (delete as appropriate):

(a) The earth fills shown on the attached Plan No _____ have been placed in compliance with the requirements of the _____ Council and my specification.

(b) The completed works take into account land slope and foundation stability considerations, subject to the appended foundation recommendations and earthworks restrictions (which should be read in conjunction with the appended final site contour plan).

(c) Subject to 3(a) and 3(b) of this Schedule, the filled ground is suitable for the erection of buildings designed according to NZS 3604 provided that:

- i. _____
- ii. _____

- (d) Subject to 3(a) and 3(b) of this Schedule, the filled ground is suitable for the erection of buildings designed according to NZS 3604 provided that:
- i. _____
 - ii. _____

- (e) The original ground not affected by filling and the filled ground are not subject to erosion, subsidence, or slippage in accordance with the provisions of section 106 of the Resource Management Act 1991 provided that:
- i. _____
 - ii. _____

NOTE – These subclauses may be deleted or added to as appropriate, to include such considerations as expansive soils where excluded by NZS 3604, and site seismic characteristics as covered in clause 3.1.3 of NZS 1170.5.

- (f) This professional opinion is furnished to the TA and the developer for their purposes alone on the express condition that it will not be relied upon by any other person and does not remove the necessity for the normal inspection of foundation conditions at the time of erection of any building.
- (g) This certificate shall be read in conjunction with my geotechnical report referred to in clause 2 above and shall not be copied or reproduced except in conjunction with the full geotechnical completion report.

Signed: _____

Date: _____

Full name: _____

Title: _____

Professional qualification: _____

Copyright waived¹

¹ Note : The above schedule is a copy of that included in NZS 4404:2010. The form is identical to Schedule 2A except in Clause 1 where the definition of a 'geo-professional' is referred to the definitions included in Section 1 of this RITS instead of the definitions included in NZS4404:2010.

3 TRANSPORTATION

3.1	Scope	86
3.2	General	86
	3.2.1 Objective.....	86
	3.2.2 Reference Documents	86
	3.2.3 Guidelines.....	89
	3.2.4 Functions of a Transportation Corridor.....	90
	3.2.5 Road Safety Audit.....	91
	3.2.6 Design and Access Statement.....	92
3.3	Engineering Design	92
	3.3.1 General.....	92
	3.3.2 Corridor Alignment, Width and Cross Section components.....	93
	3.3.3 Formation Width	95
	3.3.4 Structures	95
	3.3.5 Visibility	95
	3.3.6 Berms	96
	3.3.7 Survey Marks.....	96
	3.3.8 Cut / Fill Batters	96
	3.3.9 Intersections	97
	3.3.10 Roundabouts	99
	3.3.11 No-exit roads, Cul-de-sacs, Service Lanes and Private ways	100
	3.3.12 Road Pavement.....	102
	3.3.13 Road Surfacing.....	103
	3.3.14 Road Drainage	104
	3.3.15 Parking	108
	3.3.16 Footpaths, Pedestrian Accessways and Walkways	108
	3.3.17 Facilities for Vision Impaired Pedestrians	110
	3.3.18 Cycle Facilities	110
	3.3.19 Vehicle Crossings/Entrances.....	111
	3.3.20 Road Lighting Design	114
	3.3.21 Special Vehicle Lanes	120
	3.3.22 Traffic Control Devices – Line Marking and Signs	120
	3.3.23 Feature Entrance Walls, Berm and Street Furniture	120
	3.3.24 Safety Barriers.....	121
	3.3.25 Fencing	122
	3.3.26 Trees and Landscaping	122
	3.3.27 Structures and Underpasses	122
	3.3.28 Traffic Signals.....	123
	3.3.29 Traffic Calming Devices.....	123
	3.3.30 Over-Dimensional Vehicle Routes	124
3.4	Construction	124
	3.4.1 Pavement Materials	124
	3.4.2 New Pavement Construction.....	126
	3.4.3 Ripping and Cement Stabilisation	128

3.4.4 Testing.....	128
3.4.5 Concrete Works.....	128
3.4.6 Road Stormwater Drainage (Kerb, Channel and Catchpits) Construction	132
3.4.7 Road Surfacing Construction	134
3.4.8 Berms.....	136
3.4.9 Footpaths, Cycle Paths and Vehicle Crossings.....	137
3.4.10 Private ways.....	139
3.4.11 Road Signs.....	140
3.4.12 Pedestrian Barrier Rails and Handrails.....	146
3.4.13 Walkway Barriers and Cycle Racks	147
3.4.14 Bus Stops.....	147
3.5 Line Marking.....	147
3.5.1 Setting Out and Timing	147
3.5.2 Paint Types.....	148
3.5.3 Equipment Certificates and Staff Competence.....	149
3.5.4 Raised Pavement Markers (RPM)	149
3.5.5 Removal of Line marking	149
3.5.6 High Friction or Coloured Aggregate Surfacing.....	150
3.5.7 Coloured Markings.....	152
3.5.8 Temporary Markings.....	153
3.5.9 Non Standard Markings	153
3.6 Street Lighting Construction	154
3.6.1 Installation	154
3.6.2 Connection to network	154
3.6.3 Installation	154
3.6.4 Cables	155
3.6.5 Trenching.....	155
3.6.6 Lighting Upgrades.....	155
3.6.7 Existing Luminaires, Columns and Control Gear Made Redundant.....	156
3.6.8 Inspections and Testing	156
3.7 Traffic Signals	156
3.7.1 Scope	156
3.7.2 Specifications	156
3.7.3 Traffic Signal Equipment.....	156
3.7.4 Communications.....	158
3.7.5 Provision of Cameras.....	158
3.7.6 Warrantees, Guarantees and Maintenance.....	159
3.7.7 Design Requirements	160
3.7.8 Traffic Signal Procedure	161
3.8 Quality Systems	164
3.8.1 Inspections and Acceptance	164
3.8.2 Testing Guidelines	165
3.8.3 Testing Methods	166
3.8.4 As-built Data Provision.....	170

LIST OF APPENDICES

Appendix 3A: Transportation Corridor Hierarchy Tables 171
 Appendix 3B: Transportation Asset Data Forms 172
 Appendix 3C: Drawings 190

LIST OF TABLES

Table 3-1: List of Referenced Documents 86
 Table 3-2: Maximum Walking Distances from a Lot to a Collector or Arterial Road 91
 Table 3-3 Design Vehicle for Curve Widening 93
 Table 3-4: Minimum Intersection Spacing 99
 Table 3-5: Minimum Roundabout Design Criteria 99
 Table 3-6: Pavement Layer Thickness for Local Residential Roads 103
 Table 3-7: NZTA Guideline amendmetns or emphases 113
 Table 3-8: Road hierarchy 115
 Table 3-9: Guidelines for typical lighting schemes 116
 Table 3-10: Gap Aggregate Grading Limits 125
 Table 3-11: Gap Aggregate Grading Fraction Limits 125
 Table 3-12: Additional Signage Specifications 141
 Table 3-13: General interest sign specification 144
 Table 3-14: General interest sign locations 144
 Table 3-15: Waterborne/acrylic pain specification amendments 148
 Table 3-16: Alkyd pain specification amendments 148
 Table 3-17: Chlorinated rubber specification amendments 149
 Table 3-18: Procedures: Signal Plans, Software and Commissioning 161
 Table 3-19: Test Spacing locations and frequency 165
 Table 3-20: Procedures 166
 Table 3-21: Quality Systems Testing – Clegg Hammer Compliance Values 167
 Table 3-22: Quality Systems Testing – Nuclear Densometer Compliance Values 167
 Table 3-23: Maximum Benkelman Beam Deflections 168
 Table 3-24: Shape and Relative Height Tolerances 168
 Table 3-25: Transportation corridor hierarchy tables 171
 Table 3-26: Transportation Asset Data Forms 172
 Table 3-27: Drawing Register 190

LIST OF FIGURES

Figure 1-1:Acceptance process 21
 Figure 1-2: Standard symbols 43

LIST OF DRAWINGS

Drawing 3-1: Traffic Signal Box Sign 157
 Drawing 3-2: Terminology 193
 Drawing 3-3: Roding terminology 194
 Drawing 3-4: Location of services in transport corridor 195
 Drawing 3-5: Cross section details typical berms 196
 Drawing 3-6: Boundary splay 197
 Drawing 3-7: Standard residential privateways 198
 Drawing 3-8: Cul-de-sac head 199

Drawing 3-9: On street parking dimensions and setout	200
Drawing 3-10: Normal carriageway camber and construction tolerances	201
Drawing 3-11: C.B.R v penetration graphs for Hamilton sand silt materials.....	202
Drawing 3-12: Trench reinstatement	203
Drawing 3-13: Vehicle crossing and pedestrian cutdown set out.....	204
Drawing 3-14: Vehicle crossing profiles	205
Drawing 3-15: Kerb and channel profiles	206
Drawing 3-16: Rural entranceways - residential, light and heavy commercial	207
Drawing 3-17: Cross section details for footpath, vehicle crossings and depressed kerb and channel.....	208
Drawing 3-18: Cross section details associated kerb and channel reinstatement within existing pavement.....	209
Drawing 3-19: Concrete vehicle slot crossings	210
Drawing 3-20: Accessible bus stop	211
Drawing 3-21: Location of subsoil drainage	212
Drawing 3-22: A/C, SMA and OGPA overlay details	213
Drawing 3-23: A/C overlay v-ramp detail.....	214
Drawing 3-24: Timber edging details for chip seal, asphalt and block paving.....	215
Drawing 3-25: Pedestrian crossing point location at intersections.....	216
Drawing 3-26: Tactile paving for vision impaired	217
Drawing 3-27: Pedestrian facilities in islands	218
Drawing 3-28: Sign location and visibility at intersections.....	219
Drawing 3-29: Street name signs arterial/collector intersection	220
Drawing 3-30: Street name signs - arterial or collector intersection with local road	221
Drawing 3-31: Street name signs local/local intersection	222
Drawing 3-32: Cycle signage for off road cycle paths.....	223
Drawing 3-33: Neighbourhood watch signage.....	224
Drawing 3-34: Ground sockets for removable poles.....	225
Drawing 3-35: Installation of chevron or route and low level road name sign	226
Drawing 3-36: Attachment of street name sign blades to poles.....	227
Drawing 3-37: Street name plate.....	228
Drawing 3-38: Kea crossing flag	229
Drawing 3-39: Kea crossing flag pole.....	230
Drawing 3-40: School patrol signs.....	231
Drawing 3-41: Bus stop / taxi supplement.....	232
Drawing 3-42: Through truck route marker.....	233
Drawing 3-43: CBD cycle rack	234
Drawing 3-44: Bike rack - ribbon style.....	235
Drawing 3-45: Bike rack - hoop style.....	236
Drawing 3-46: Lockable removable bollards	237
Drawing 3-47: CBD pedestrian barrier	238
Drawing 3-48: Pedestrian balustrade barrier	239
Drawing 3-49: Pedestrian barriers.....	240
Drawing 3-50: Pedestrian accessways fence detail.....	241
Drawing 3-51: Pedestrian handrail or walkway barrier	242
Drawing 3-52: Concrete base details for steel litter bins.....	243
Drawing 3-53: Standard 3.5m bus shelter foundation detail	244
Drawing 3-54: Bus shelter and mini bus shelter	245

Drawing 3-55: Bus stop seat no shelter..... 246

Drawing 3-56: Typical cycle advance stop lines layout..... 247

Drawing 3-57: On-road cycle lane connection to off road shared path 248

Drawing 3-58: Clearway and P5 roadmarking 249

Drawing 3-59: Mobility cardholders parking 250

Drawing 3-60: Roundabout details 251

Drawing 3-61: Flush threshold 252

Drawing 3-62: Paved raised pedestrian ramp 253

Drawing 3-63: Concrete raised pedestrian ramp 254

Drawing 3-64: Asphaltic concrete tapered raised pedestrian ramp..... 255

Drawing 3-65: Asphaltic concrete full width raised pedestrian ramp..... 256

Drawing 3-66: Full width raised pedestrian threshold imprint patterns and coloured surfaces..... 257

Drawing 3-67: Pedestrian belisha and warning globe detail 258

Drawing 3-68: Pedestrian belisha and floodlighting..... 259

Drawing 3-69: Traffic signal ducting under kerb access details 260

Drawing 3-70: Fold down traffic signal pole..... 261

Drawing 3-71: Removable traffic signal pole 262

Drawing 3-72: Standard dimensions for stop line detectors..... 263

Drawing 3-73: Street name signs at signalised intersections..... 264

Drawing 3-74: Traffic signal pole and mast arm 265

Drawing 3-75: Hamilton city specific requirements - Cityheart..... 267

Drawing 3-76: Hamilton city specific requirements - streetscape revitalisation 268

Drawing 3-77: Hamilton city specific requirements – street furniture and planting strategy..... 269

Drawing 3-78: Hamilton city specific requirements - street furniture and planting strategy..... 270

Drawing 3-79: Hamilton city specific requirements - soft landscape examples 271

Drawing 3-80: Hamilton city specific requirements –CBD core paving treatment 272

Drawing 3-81: Hamilton city specific requirements - CBD core paving treatment at corners..... 273

Drawing 3-82: Hamilton city specific requirements - main street paving treatment 274

Drawing 3-83: Hamilton city specific requirements - main street paving treatment at corners..... 275

Drawing 3-84: Hamilton city specific requirements – CBD fringe paving treatment..... 276

Drawing 3-85: Hamilton city specific requirements - CBD fringe paving treatment at corners..... 277

Drawing 3-86: Hamilton city specific requirements - Mid block speed table crossing point..... 278

Drawing 3-87: Hamilton city specific requirements - Section A: Typical footpath section - retail edge..... 279

Drawing 3-88: Hamilton city specific requirements - Section B: Typical footpath section - adjacent to carpark 280

Drawing 3-89: Hamilton city specific requirements - City heart kerb profiles 281

Drawing 3-90: Hamilton city specific requirements - Deco pole with 2m outreach 282

LIST OF EQUATIONS

No table of figures entries found.

3.1 SCOPE

This Section sets out the requirements for the design and construction of transportation corridors within the city/district that are, or will be, managed by or vested to Council. It is also to be used for maintenance of existing infrastructure, including asset renewal, unless the standards are not compatible with the existing assets.

3.2 GENERAL

3.2.1 Objective

The objective is to provide a hierarchical network of transportation corridors that respond to land use and land form, provide safe and convenient transport for all road user modes, provide access to adjacent property, travel choices, are well connected, safe to use and provide corridors for utility services. They must be consistent in their design standards to provide uniform guidance to users and be designed and built to provide the least whole of life cost to the community, consistent with the desired level of service.

3.2.2 Reference Documents

Details of documents referenced in this Section are as follows:

Table 3-1: List of Referenced Documents

STANDARD/LEGISLATION	TITLE
AS 1141.32.2008	Methods for sampling and testing aggregates - Weak particles (including clay lumps, soft and friable particles) in coarse aggregates
AS 2144:2014	Traffic Signal Lanterns
AS 2353:1999	Pedestrian Push-button Assemblies
AS 289.5-1993	Parking Facilities – On-street parking
AS/NZS 1158 Set	Lighting for Roads and Public Spaces Set
AS/NZS 2276.1:2004	Cables for traffic signal installations - Multicore power cables
AS/NZS 2276.2:1998	Cables for traffic signal installations - Feeder Cable for Vehicle Detectors
AS/NZS 2276.3:2002	Cables for traffic signal installations - Loop Cables for Vehicle Detectors
AS/NZS 2312:1:2014	Guide to the Protection of Structural Steel Against Atmospheric Corrosion by the Use of Protective Coatings with 2004 Amendments - Part 1: Paint coatings
AS/NZS 2312.2:014	Guide to the Protection of Structural Steel Against Atmospheric Corrosion by the Use of Protective Coatings with 2004 Amendments - Part 2 : Hot dip galvanising
AS/NZS 3000: 2007	Electrical Installations (known as Australian/New Zealand Wiring Rules)
AS/NZS 3845.1:2015	Road safety barrier systems and devices
AS/NZS 4819:2011	Rural and urban addressing
ASTM C309:2011	Specification for liquid membrane-forming compounds for curing concrete
BS 381C	Colour chart for paints
S 812-114:1989	Testing aggregates. Method for determination of the polished-stone value
NZS 3104 : 2003	Specification for Concrete Production

STANDARD/LEGISLATION	TITLE
NZS 3109 : 1997	Concrete construction
NZS 3116:2002	Concrete segmental and flagstone paving
NZS 3910:2013	Conditions of Contract for Building and Civil Engineering Construction
NZS 4121: 2001	Design for Access and Mobility – Buildings and Associated Facilities
NZS 4402.4.1.1:1986	Test 4.1.1 NZ Standard Compaction Test
NZS 4402.4.1.3:1986	Test 4.1.3 NZ Vibrating Hammer Compaction Test
NZS 4404:2010	Land development and subdivision infrastructure
NZS 4407:2015	Methods of sampling and testing road aggregates
NZS/AS 1657: 1992	Fixed platforms, walkways, stairways and ladders - design, construction and installation

NZ Transport Agency (NZTA) Standards, Specifications and Guidelines

NZTA	Code of Practice for Temporary Traffic Management
NZTA	Guidelines for Public Transport and Infrastructure and Facilities
NZTA	Infrastructure Risk Rating (IRR) Manual
NZTA	Land Transport (Road User) Rule 2004
NZTA	Land Transport Rule - Traffic Control Devices 2004 (with amendments)
NZTA	Manual of Traffic Signs and Markings (MOTSAM) – Part 1 : Traffic Signs - Part 2 : Markings
NZTA	Road Safety Audit Procedures for Projects (Transfund 2004); interim update 2013
NZTA	Supplement to 2004 Austroads Pavement Design Guide (2007)
NZTA	Traffic Control Devices Manuals

NZ Transport Agency (NZTA) Guides

NZTA	Pedestrian Planning and Design Guide (2009)
NZTA	Cycling Network Guidance – planning and design
NZTA	Making Roads Motorcycle Friendly
NZTA	Speed Management Guide Speed Management Toolbox and Appendices

NZ Transport Agency (NZTA) Traffic Notes

NZTA Traffic Note 48	Light Vehicle Sizes and Dimensions : street survey results and parking space requirements
----------------------	---

NZ Transport Agency (NZTA) Manuals

NZTA	Bridge Manual SP/M/022 (2013)
NZTA RTS 4	Guidelines for Flush Medians (1991)
NZTA RTS 6	Guidelines for Visibility at Driveways (1993)
NZTA RTS 11	Urban Roadside Barriers and Alternative Treatments (1995)

NZTA RTS 14	Guidelines for Facilities for Blind and Vision Impaired pedestrians (2015)
NZTA RTS 18	NZ On Road Tracking Curves for Heavy Vehicles (2007)
<i>NZ Transport Agency (NZTA) Specifications</i>	
NZTA B/2	Construction of Unbound Granular Pavement Layers
NZTA B/5	In-Situ Stabilisation of Modified Pavement Layers
NZTA C/20	Erection and Maintenance of Traffic Signs Chevrons Markers and Sight Rails
NZTA F/1	Earthworks Construction
NZTA F/2	Pipe Subsoil Drain Construction
NZTA F/5	Corrugated Plastic Pipe Subsoil Drain Construction
NZTA M/1	Roading Bitumens
NZTA M/4	Basecourse Aggregate
NZTA M/6	Sealing Chip
NZTA M/7	Line Marking Paint
MZTA M/7	Notes to Line marking Paint Specification (M/7)
NZTA M/10	Asphaltic Concrete
NZTA M/12	Raised Pavement Markers specification
NZTA M/14	Edge Marker Posts
NZTA M/17	W-Section Bridge Guardrail Specification
NZTA M/20	Long Life Line Marking Materials Specification
NZTA M/20	Notes to Long Life Line Marking Materials Specification (M/20)
NZTA M/23	Bridge Approaches and Specification for Road Safety Barrier Systems Appendix A - List of Compliant Road Safety Hardware for Accepted Products (with interim acceptances)
NZTA M/24	Audio Tactile Profiled Road Markings Specification
NZTA M/26	Specification for Lighting Columns Appendix A – Type Approved Passively Safe Lighting Columns
NZTA M30	Specification and guidelines for Road Lighting design
NZTA P/3	First Coat Sealing
NZTA P/4	Resealing
NZTA P/9	Asphaltic Concrete Paving Construction
NZTA P/11	Open Grade Porous Asphalt
NZTA P/12	Pavement Marking Specification
NZTA P/12 Notes	Notes to Pavement Marking Specification (P/12)
NZTA P/14	Specification for Installation of Raised Pavement Markers
NZTA P/15P	Fabrication and Assembly of Standard Guardrails and Handrails for Highway Bridges
NZTA P/22	Reflectorised Pavement Marking Specification
NZTA P/43	Specification for Traffic Signals
NZTA T/1	Benkelman Beam Deflection Measurements

NZTA T/8	Road marking Applicator Testing Specification
NZTA T/12	Long-Life Pavement Marking Material Applicator Testing

Austrroads Guides

Austrroads Guide to Road Design	Part 3: Geometric Design
Austrroads Guides to Road Design	Part 4: Intersections and Crossings
Austrroads Guides to Road Design	Part 4A: Unsignalised and Signalised Intersections
Austrroads Guide to Road Design	Part 4B : Roundabouts
Austrroads Guides to Road Design	Part 4C: Interchanges
Austrroads Guide to Road Design	Part 6A: Pedestrian and cyclist paths
Austrroads Guide to Pavement Technology	Part 2 : Pavement Structural Design
Austrroads Guide to Traffic Management	Part 10 : Traffic Control and Communication Devices
Austrroads Pavement Design for Light Traffic	

Other Documents

Thick Brick Australia	Clay Paving Design
Ministry for the Environment (MfE)	Crime Prevention through Environmental Design (CPTED)
Health and Safety at Work Act 2015	
Manual for Streets (UK Dept for Transport) 2007	
New Zealand Building Code	
NZ Roadmarkers Federation (NZRF)	Manuals Industry ‘Best Practice’
Road Safety Manufacturers Association (RSMA)	Compliance Standard for Traffic Signs (2010)
Electricity Regulations 2010	
Electricity (Safety) Regulations 2010	
NZ Electrical Code of Practice for Electrical Safe Distances (NZECP 34:2001)	
The Electricity Act 1992	

3.2.3 Guidelines

In designing the layout of a Transportation Corridor the following issues must be considered:

- a) Zoning and likely use of the adjacent land
- b) Land form and geological and cultural features
- c) Connections to existing transport corridors
- d) Linkages to other developments and amenities

- e) Relationship to the concept for the total area
- f) Recognition of the One Network Road Classification hierarchy ²
- g) The relevant Council's District Plan
- h) Public transport requirements
- i) Service/utility corridors and the impact the development will have on the capacity of the utilities in the adjacent areas
- j) Protection of unique features
- k) Pedestrian needs
- l) Cyclist needs
- m) Needs of mobility or visually impaired persons
- n) Stormwater collection, treatment and disposal
- o) Access by vehicles needing to service the area e.g. refuse collection, street cleaning
- p) Risk, reliability and redundancy
- q) Green space and vegetation
- r) Whole of life costs for the operation and maintenance of the asset including ease of cleaning, procurement and replacement of infrastructure when vandalised, damaged or at the end of its design life.
- s) Mitigation of adverse effects of traffic:
 - (i) Volume
 - (ii) Speed
 - (iii) Manoeuvrability
 - (iv) Function
 - (v) Parking
 - (vi) Safety
 - (vii) Noise, air and water pollution

3.2.4 Functions of a Transportation Corridor

A Transportation Corridor provides a space for interaction between people for a range of purposes and access to land uses so that movement between places can occur.

Refer to the relevant District Plan for the transportation functional classification.

The three key functions of a Transportation Corridor are movement, place context and utility corridor.

3.2.4.1 Movement

Linking places with transportation infrastructure that provides for a range of transport modes to move people and goods efficiently.

² The RITS is based on the HCC ITS, and that document had many roading heirachy statements similar but slightly diferrent to ONRC. As a result, users need to be aware that this is an area of work that is still to be done late in 2018.

3.2.4.2 Place Context

Creating public spaces for people to interact, exercise and enjoy where appropriate. There are some transportation corridors where such activities would create health and safety issues. The place function would be limited in such situations e.g. arterials and expressways.

3.2.4.3 Utility Corridor

Providing corridors that network utility operators can use to service the city (e.g. telecommunication, fibre, electricity, three waters, and gas networks).

3.2.4.4 Transportation Corridor Hierarchy

Each Council currently has their own transportation corridor hierarchy. These can be found in the relevant District Plan.

3.2.4.5 Network Connectivity

Well-connected urban networks (roads and other links) are achieved with smaller block sizes and regular connections. Network connectivity shall be designed to achieve:

- a) Shorter travel distances
- b) An increased number of alternative routes for all types of users (noting that this is not the case with arterials and expressways).
- c) Increased opportunity for communities to interact, e.g. socialise, play together, etc.
- d) Improved access to; public transport, cycling and walking networks, access to destinations such as schools, amenities and employment

Development design shall ensure connectivity to properties and roads that have been developed, or that have the potential to be developed in the future. The design shall ensure the maximum walking distances in the following Table 3-2 from a lot to a collector or arterial road.

Table 3-2: Maximum Walking Distances from a Lot to a Collector or Arterial Road

Rural road	No maximum distance. The design should maximise future connectivity to a suburban network.
Suburban	400m. A shorter distance shall be considered near centres and major public transport routes
Urban	300m
Centre	200m

Provision of safe and accessible crossing points across collectors and arterials will also be necessary to ensure that Network connectivity between blocks is maintained.

3.2.5 Road Safety Audit

Proposals for new roads, intersections or facilities/features that will be vested in Council shall generally be subject to the NZTA Road Safety Audit Procedures for Projects at detailed design and post construction stages, unless Council decides that these are not required. The 'exemption declaration' shall be submitted as part of the

application process to be considered by Council. An 'exemption declaration' may be completed for any or all stages of the project if in the opinion of a suitably qualified road safety auditor an audit is not necessary and Council will then consider and decide whether to accept it or not.

Safety audits must address the needs of all road users, including the needs of pedestrians, cyclists, motorcyclists and disabled/elderly users. Where appropriate, the requirements of these groups may demand specific audit procedures.

Recommendations from the audit report(s) shall be implemented before the 224 certificate is issued or the contract works accepted for practical completion.

3.2.6 Design and Access Statement

A design and access statement shall be submitted with the application for design approval. The statement shall cover all relevant aspects of this Specification and specifically address:

- a) Road dimensions and layout;
- b) Link and place functions;
- c) Connectivity and how it will be achieved for all road user types;
- d) How safe and appropriate speeds will be achieved and managed through design (in accordance with NZTA Speed Management Guide) and the design speed environment;
- e) How any 'serious and critical' issues identified in the road safety audit have been addressed;
- f) Parking, passing and loading provisions;
- g) Criteria used in determining visibility distances and splays;
- h) Safety barrier requirements and considerations that have been made for alternative treatments;
- i) Impact on existing street features such as street furniture, pedestrian refuge facilities, bus stops & shelters, for visual consistency and also potential increase in usage;
- j) Any new parking restriction that will be required in order for the proposed design to operate safely, eg no stopping.

3.3 ENGINEERING DESIGN

3.3.1 General

Roads shall be designed with reference to the transportation functional classification table contained in the relevant District Plan and NZS 4404 Section 3.3. However all references within Section 3.3 (NZS 4404) to Table 3.2 (NZS 4404), shall be taken instead to refer to the table in the relevant district plan.

3.3.1.1 Design Speed Environment

The relationship between carriageway width, forward visibility and the design speed environment for various road types is illustrated in Fig 3.2 of NZS 4404.

Traffic management facilities shall be included in the road design to ensure that the design speed environment shown is achieved.

Design speed environments can be managed by physical and psychological devices such as narrowed movement lanes, reduced forward visibility, parking, slow points, build outs, chicanes, planting and landscaping, and street furniture and art works.

The Austroads Guide to Road Design - Part 3 : Geometric Design provides suitable guidance for designing to a design speed. Reference can also be made to the Manual for Streets (UK Department for Transport) and the NZTA Speed Management Guide Toolbox and Appendices.

3.3.1.2 Special Character Zones or Specific TLA Requirements

Where Special Character Zones (residential, heritage, natural, etc) are identified in the relevant district plan, or specific requirements relating to street furniture etc exist, there may be associated local variations to the RITS.

3.3.2 Corridor Alignment, Width and Cross Section components

Horizontal alignment of transport corridors shall be based on terrain and the design speed applicable to the road function. Vertical alignment of residential roads should ensure that inclines can be negotiated during all weather conditions and sight distances are adequate for safety. The gradient shall be considered as a planning factor when selecting locations for shopping centres, service centres, or footpaths.

The minimum centreline radius for industrial roads, residential collector and sub-collector roads is 80m. The minimum centreline radius for local residential roads is 15m. Reverse curves are to be separated by an adequate length of straight in metres of 0.7 times the posted speed limit.

3.3.2.1 Lane Widening

Where the centreline radius is 80m or greater, extra widening on curves is not required. Where curves are less than 80m radius, extra widening may be applied to the carriageway to ensure that heavy vehicles are able to negotiate the curve wholly within their lane. In such cases, the minimum berm width shall not be reduced.

Table 3-3: Design Vehicle for Curve Widening

ROAD CLASSIFICATION	DESIGN VEHICLE
Arterial Collector and Industrial roads*	19m Semi-Trailer
Local roads and lanes (excl industrial zones)	11.5m Rigid

*** As defined in the relevant District Plan**

3.3.2.2 Visibility

The road centre line radius and the road width also affect the visibility along the road, particularly on the inside road boundary of the curve.

As such, in addition to carriageway widening, there is a need to also check that horizontal visibility meets the road design speeds both on the inside of the curve and also at vehicle entrances and access way. Achieving this may result in a need to increase the berm width by adjusting property boundaries.

3.3.2.3 Carriageway Crossfall

Minimum crossfall is 1:33 for chip seal surfaces, 1:50 for asphaltic concrete surfaces and 1:25 for unsealed surfaces.

Maximum crossfall is 1:25, with the exception of where vehicles and pedestrians operate in shared zone environments. In shared zone environment, carriageway crossfall shall comply with footpath requirements.

Single crossfall will be considered on carriageways up to 7.0m where normal crossfall is unobtainable.

3.3.2.4 Super Elevation

Maximum super elevation is 1:17.

Super elevation should be used on short radius curves on roads with operating speeds of greater than 40km/h.

3.3.2.5 Gradients

- a) Minimum gradient is 1:250
- b) Maximum gradient (on arterial, collector and industrial roads) is 1: 12
- c) Maximum gradient (on residential roads) is 1:8

Steeper gradients may be acceptable for shorter lengths of road in hilly country or low overall speed environments, subject to approval by Council in accordance with Part 329 (road gradients) of the Local Government Act 1974. However, consideration of these steep grades is to be taken into account in the design of adjacent footpaths.

3.3.2.6 Vertical Curves

Vertical curves shall comply with the requirements of Austroads Guide to Road Design Part 3: Geometric Design, section 8.6 Vertical Curves. For areas where the design speed is ≤ 50 km/h, vertical curves shall have a minimum length of 20m, except where the grade change is $\leq 1:100$ where the minimum vertical curve length is 10m for centre lines. Kerb and channel grades should not be flatter than 1: 300 within the vertical curve.

3.3.2.7 Cross-section

Typical road widths are provided in the relevant district plan. Preservation or capitalisation of some natural feature of a landscape or existing specimen tree(s) may dictate an irregular shaped road width.

Certain carriageway and berm geometrics, utility services and stormwater swales, may require that the road width be increased, but usually just locally.

3.3.2.8 Road Reserve

In some circumstances an increased overall road reserve may be necessary for utilities provision or increased amenity, stormwater treatment and drainage, landscape or urban design element. In other circumstances, reserve widths may be reduced if development is only on one side of the road or the road is only one way.

All rural road reserve boundaries shall be fenced. Livestock fencing requirements are contained in [Section 7](#) - Clause 7.3.12.2.

3.3.2.9 **Movement Lanes**

One movement lane in each direction is typical but the requirements vary according to the nature and function of the road. Refer to the relevant district plan.

3.3.2.10 **Parking, Passing and Loading**

Allowance for parking, passing and loading activities shall be provided in accordance with the relevant district plan and section 3.3.6 of NZS 4404.

3.3.2.11 **Cycle Facilities**

Cycle facilities shall be provided in accordance with the requirements set out in the relevant district plan and/or cycle/biking plan and shall be marked in accordance with the Traffic Control Devices Manual and the drawings contained in this document.

3.3.2.12 **Shoulder Widths**

Shoulder widths on rural roads need to be assessed for each project, based on the speed environment of the area, terrain and activities. For high speed environments where high non-motorised use is expected, shoulder widths may need to be increased to optimise overall road safety. Refer to the relevant Council's District Plan.

3.3.3 **Formation Width**

Formation width shall be sufficient to contain the functions described in 3.3.2.8 above. Where topography dictates, the formation width should extend beyond the carriageway edge by 500mm, with batters providing a smooth and safe transition to the adjacent building lot grades. Refer to [Drawing D3.1.1](#).

3.3.4 **Structures**

Where structures retaining private lots are required, these shall be fully located on the lot, not within the road reserve.

3.3.5 **Visibility**

The driver sight distance requirements relate to the road classification function and vehicle speeds. Refer to NZTA RTS 6.

Visibility splays and envelopes may require the road boundary to be set back (refer to [Drawing D3.1.5](#)). Trees shall not be planted in the visibility splay; only road lighting columns and road signs shall be considered. More detail on requirements for planting within visibility splays is given in the landscape section.

Horizontal and vertical sight distances along a road shall be designed in accordance with Austroads Guide to Road Design Part 3: Geometric Design, considering the wet surface coefficient. The stopping sight distance measured round a curve shall be along a line 1.5m into the lane width from the inside kerb.

The developer shall submit with the engineering plans the criteria used in determining the visibility distances.

3.3.6 Berms

Berms shall be provided between the edge of the formed carriageway and the road legal boundary to accommodate footpaths, road signs, road lighting, underground services, landscaping, stormwater treatment and control and grass areas. (Refer [Drawing D3.1.3](#))

Berms shall be of adequate width to:

- a) Achieve safe clearances between the carriageway edge and any obstacle (minimum 600mm for urban and 1500mm for rural areas).
- b) Allow running of utility services and placing of street lighting poles within the berm
- c) Provide adequate space between the road reserve boundary and the carriageway edge to enable residents to safely enter the road traffic
- d) Allow room for efficient road edge and edge drain maintenance
- e) Allow adequate space for the effective operation and maintenance of any form of stormwater management device
- f) Allow sufficient width to allow for adequate growth of the plants/ trees and ease of their maintenance.
- g) Allow for use of a lawnmower for general maintenance - narrow grass strips less than 650mm wide should be avoided
- h) Allow for the safe kerbside collection of rubbish and recycling (minimum 2500mm x 1000mm space for presentation and collection of rubbish and recycling)

The minimum width of berm shall be in accordance with the relevant District Plan except for private ways (Refer [Drawing D3.1.6](#)) and shared environments.

Berm crossfall shall typically be 1:25, however localised grass berm cross falls may range between 1:50 and 1:10 but must be able to be easily mown by the adjacent property owner. Engineering drawings should identify any variances from the typical crossfalls. The berm crossfall (maximum 1:10) and the footpath cannot be negatively impacted by the vehicle crossing which has a maximum grade of 1:6. (Refer [Drawing D3.1.4](#))

On rural roads berm crossfall to be a maximum of 1:4 starting at the edge of the carriageway shoulder or surface water channel.

3.3.7 Survey Marks

Survey marks shall be installed in a separate, purpose built concrete slab, clear of vehicle and pedestrian facilities.

3.3.8 Cut / Fill Batters

To be read in conjunction with [Earthworks Section 2](#).

3.3.8.1 Urban Roads

Cut and fill batters for roads shall generally be constructed outside the Transportation Corridor (refer clause 3.2.6 for berms).

- a) With a maximum grade of 1:5 starting at the road boundary. Where circumstances dictate a steeper grade is necessary, and it is longer than 10

metres, a geotechnical assessment of the slope shall be provided together with specific access design (Refer to [Earthworks Section 2](#)).

- b) Any retaining wall designed to support the road or footpath shall be constructed within the transportation corridor and will likely require a building consent
- c) Where Council consider the stability of any planned embankment is in doubt, a stability analysis of the slope under saturated conditions may be required

3.3.8.2 Rural Roads

- a) Rural batters for cuttings and embankments shall usually be constructed inside the Transportation Corridor
- b) Batters less than 750mm high shall be cut at 1:4 and shall be topsoiled and grassed. (Refer to [Landscape Section 7](#), Clauses 7.3.4 and 7.3.6)
- c) Batters 750mm high and above shall be cut at 1:2 and shall be protected from face erosion by hydro-seeding or similar (refer to Landscape Section)
- d) Batters 4.5m high and above shall be assessed by a Geotechnical Professional. In undertaking this check and determining the appropriate erosion protection the Geotechnical Professional shall take into account:
 - (i) The type of soils present in the cutting
 - (ii) The degree of possible erosion and its effect on long term stability, the safety of road users, and adjacent property owners

3.3.9 Intersections

3.3.9.1 Intersection and Alignment Design

All intersections shall be designed in accordance with Austroads Guides to Road Design parts 4 and 4A.

Generally, in urban areas, roads should intersect only with roads in the same class or those immediately above or below in classification. T-junctions are preferred to cross intersections particularly for local roads. The angle of intersection should be 90°, although a minimum angle of 70° can be used when justified by other constraints. Multi-leg intersections may require control by roundabouts. Intersections on curves, particularly on the inside of curves, other than large radius curves, are to be avoided.

All road intersections in residential areas should have a kerb radius at intersections of 4m to 6m. An alternative and reduced kerb radius may be considered to enhance pedestrian facility in low speed environments, and shall be subject to the approval of Council.

All intersections in industrial areas should have a minimum kerb radius of 13.5m with corner splays of 6m, or subject to specific design.

Intersections in all other 50 km/h or lower speed environments shall have the lot corners splayed by a minimum of 4m along both boundaries, although these may be dispensed with in low design speed environments provided that there is adequate provision for pedestrians and utility services.

Corner boundary splays shall be subject to specific design in higher speed environments, to ensure safe visibility at intersections.

3.3.9.2 Arterial Road Intersections

For intersections with arterial roads, the engineering plans shall show the sight distance provided at each intersection, plus the following information:

- a) Design Speed
- b) Design Vehicle
- c) Distance from limit lines to viewpoint (LV)
- d) Approach Sight Distance (ASD)
- e) Safe Intersection Sight Distance (SISD)
- f) All radii

The SISD shall be determined with an object of height 0.6m.

Reference can also be made to Austroads Guides to Road Design Parts 4, 4A and 4C.

3.3.9.3 Intersections with State Highways

In the case of roads intersecting or joining State Highways, consultation must be undertaken with the NZTA with regard to appropriate standards prior to commencing design.

3.3.9.4 Grades at Intersections

Gradients within 30m of intersections shall be:

- a) For Local Roads - less than 1:33 where practicable and not greater than 1:10
- b) For Collector and Arterial Roads - less than 1:50

A plateau with minimum grades, of at least 10m is to be provided at any intersection where a vehicle may be expected to stop and give way to other vehicles e.g. at a Give Way control.

3.3.9.5 Channelisation at Intersections

All side roads that have direct access to a collector or arterial road (existing or proposed as defined by the relevant District Plan and/or Structure Plan) shall be channelised using either kerb extensions and / or a central throat island at the intersection with the collector or arterial road. Such treatments are to be designed and constructed in accordance with this specification. Side roads expected to carry less than 120 v.p.d (12 dwellings) and have a carriageway width of 8m or less do not require channelisation.

3.3.9.6 Priority Controls

All priority intersections must fulfil the requirements of the Land Transport Rule: Traffic Control Devices 2004, associated NZTA Traffic Control Devices Manuals, and the NZTA Pedestrian Planning and Design Guide.

3.3.9.7 Intersection Spacing

Minimum permitted spacing between adjacent intersections on different categories of road are set out in Table 3-4 below. All distances are measured along the centreline of the major road between the centrelines of the intersecting roads.

Table 3-4: Minimum Intersection Spacing

	LOCAL ROADS	COLLECTOR OR ARTERIAL ROADS	INDUSTRIAL ROADS
Same Side	60m	90m	200m
Opposite Side	30m	45m	100m

In all cases a right/left stagger is preferred. If cross roads are unavoidable a roundabout is required for all but low volume local roads.

3.3.9.8 Road Rail Intersections

Road rail level crossings shall be designed in accordance with the NZTA Traffic Control Devices Manual; Part 9 Level Crossings.

3.3.10 Roundabouts

Roundabouts may be required at intersections where Stop or Give Way controls do not provide adequate capacity or Level of Service, or to provide traffic calming. Roundabouts are not permitted where their prime purpose is to provide a landscaping opportunity.

Roundabouts shall be designed in accordance with Austroads Guide to Road Design Part 4B: Roundabouts. The size of a roundabout has a significant role in the performance for capacity, traffic safety and turning movements of vehicles. The minimum design criteria outlined in Table 3-5 shall be applied. Refer Drawing D3.10.1

Table 3-5: Minimum Roundabout Design Criteria

ROAD TYPE	CENTRAL ISLAND DIAMETER	CIRCULATING WIDTH	LV DISTANCE*
Local (Access) road	16m including a 2m concrete collar	Single lane – 7.0m	5.0m
Collector (Primary and Secondary) road	20m including a 2m concrete collar	Single Lane – 7.0m Dual lane – 10.5m	9.0m
Arterial (Primary and Secondary) or Industrial road	24m including a 2m concrete collar	Single Lane – 7.0m Dual lane – 10.5m	9.0m

(*LV distance is defined as the minimum distance from limit lines to point of view)

Visibility is an important factor to ensure safety standards are met, Austroads Guide to Road Design Part 4B, Criteria 1 and 2 for sight distance are both mandatory requirements. Achievement of Criterion 3 is desirable.

Minimum criterion may be reduced if:

- a) Physical constraints such as a building/structure prevent practical implementation of minimum design criterion
- b) Roundabout can be shown to form a traffic control device as part of a Local Area Traffic Management scheme

Any roundabout below the desirable design criteria requires approval by Council.

Supporting evidence to show that the design will meet capacity, safety and turning movements of intended vehicles, including motorcycles (refer NZTA Guide 'Making Roads Motorcycle Friendly' shall be supplied.

Traffic modelling shall be provided to show that the design can mitigate the effects of traffic generation due to the development. Where applicable, consideration shall be given for future network growth and development. This could include intersection modelling using software such as SIDRA.

The engineering plans shall show, the visibility splays for each approach of each roundabout, landscaping details, signage, road marking, and state the:

- a) Design Speed – both approach and circulating
- b) Design Vehicle and Turning Path
- c) LV Distance
- d) Central Island Diameter
- e) Circulating Width
- f) Level of Service
- g) Provisions for pedestrians and cyclists to ensure their safety when negotiating the roundabout

A copy of the Safety Audit and evidence of compliance with recommendations must be included.

3.3.11 No-exit roads, Cul-de-sacs, Service Lanes and Private ways

3.3.11.1 No Exit Roads

'No-exit' roads should not be provided where through roads and connected networks can be designed. Where no-exit roads cannot be avoided, they should ensure connectivity for pedestrians and cyclists and have no-exit signage.

Public no-exit roads and lanes shall provide for road turning at the end of the road for an appropriate vehicle as described in NZTA standard RTS 18. No Exit roads shorter than 60m may provide reduced turning facilities but must cater for 11m rigid trucks (e.g. rubbish collection). The design of turning facilities for light vehicles in urban areas shall be in accordance with AS 2890.5. See Figures 3.3 and 3.4 for acceptable solutions.

Turning heads will be required at the end of all rural no exit roads in accordance with Austroads Rural Road Design.

An on-road turning area may provide for parking or landscaping/hard standing in the centre of the turning area. The minimum kerb gradient around turning heads shall be 1:200. Appropriate drainage shall be provided.

3.3.11.2 Cul-de-sac Design

The design of cul-de-sac turning areas shall be in accordance with [Drawing D3.1.7](#) or NZS4404 except in commercial and industrial areas where the minimum radius shall be 15m to accommodate the turning movements of service vehicles.

The maximum long or cross section slope in turning heads is 1:17, with the desirable matching normal camber.

All urban roads shall have kerb and channel with associated stormwater collection and disposal systems provided on all cul-de-sac heads to the tangent point.

Staged road construction will require temporary cul-de-sacs to be built.

For rural roads, Council may require kerb and channel with associated stormwater collection and disposal systems to be provided on cul-de-sac heads where conventional shoulder/berm surface runoff is unable to be achieved to Council's satisfaction.

3.3.11.3 Service Lanes

The minimum carriageway width permitted is 3.5m. Service Lanes are to have concrete edging both sides and stormwater is to be collected and disposed of. Specific geometric and pavement design is required, as covered in clause 3.3.12 and the relevant council's formation requirements as set out in their district plan. Carriageway surfacing is to be asphalt conforming to the specifications in clauses 3.3.13.2 and 3.4.9.8.

3.3.11.4 Private ways

General

Kerb and channel for Urban Residential and Industrial private ways is to be in accordance with Drawings [D3.3.1](#), [D3.3.2](#) and [D3.3.3](#).

Stormwater shall not discharge across the vehicle crossing from the private way to the road.

Vehicle crossings to private ways shall be designed and constructed in accordance with Clause 3.3.19 and [Drawing D3.1.6](#) (Urban Residential).

Surfacing requirements shall be in accordance with clauses 3.2.13.2, 3.4.9.8 and 3.4.10.

Urban Residential Private ways

Urban residential private ways are to be in accordance with the relevant District Plan (see Appendix 3A: Transportation Corridor Hierarchy Tables).

The minimum permitted inside radius of curves shall be 9.0 m. The gradient shall not exceed 1:6. Where the gradient exceeds 1:6, any safety provisions required by Council shall be provided. A passing bay shall be provided at every 75m of private ways.

Industrial Private ways

- a) The minimum carriageway width for an industrial private way serving a single lot is 4m. For an industrial private way serving two or more lots the minimum carriageway width is 6.4m. Berm widths each side are to be 1.8m minimum. The minimum permitted inside radius of curves is 12m.

Rural Residential Private ways

- a) For rural residential private ways serving ≤ 4 lots and ≤ 250 m in length, the total minimum permitted sealed carriageway width is 3.5m, with the total width of the private way a minimum of 7.0m.
- b) For rural residential private ways serving ≥ 5 lots or ≥ 250 m length, the total minimum permitted sealed carriageway width is 4.0m, with the total width of the

private way a minimum of 7.5m. The crossfall shall be 1:25. A passing bay should be considered.

3.3.12 Road Pavement

Pavements shall be provided to all roads such that vehicle loads may be carried without distress, in all weathers, for at least the design life with only normal routine maintenance and periodic re-surfacing. Pavements shall generally be flexible granular pavements with thin surfacing layers, however where this is not sufficient or a more innovative solution can be implemented, it may be approved by Council.

Stabilisation additives are not permitted in new pavement construction, unless specifically agreed to by Council.

3.3.12.1 Pavement Design

A pavement design may be carried out by one of the following methods:

Sealed Pavement - Specific Design

This method shall be used for all industrial and high volume (over 3000 vpd) residential roads. It may be used for roads of lower classification.

Pavement design shall use the methodology of Austroads Guide to Pavement Technology, Part 2 and the NZ Supplement to the Austroads Pavement Design Guide.

Designs for local roads may also use Austroads Pavement Design for Light Traffic.

Use of alternative materials such as recycled aggregates or the treatment of lower grade material is encouraged. The use of stabilisation agents may be considered by Council for subgrade and sub-base improvement, but not basecourse stabilisation.

Factors to be included in the design are:

- a) Design Period - 25 years
- b) Trips generated per household per day - 10
- c) Annual HCV growth factor - 3 % minimum unless otherwise outlined by Council
- d) Load factor the Presumptive ESA/HCV of 1.44 shall be used for design purposes unless otherwise outlined by Council.
- e) % HCV 1.5% local residential road/3.5% collector and higher classification/10% industrial and 9% rural roads

The design report shall provide the following information as a minimum.

- Results of soils investigations
- Design assumptions and figures
- Material specifications
- Engineering Drawings
- QA measures for construction

Sealed Pavement - Default Design

This method may be used for local residential roads only. Using this design does not exempt the construction from any tests nor compliance with any targets and does not provide any guarantee that the resulting pavement will comply with all testing requirements. Pavements shall comply with the depth and aggregate specified in the following table.

Table 3-6: Pavement Layer Thickness for Local Residential Roads

ROAD TYPE	SUBBASE	BASECOURSE	NOTES
Cul de sac	N/A	150mm GAP 40	(ESAs 100,000)
Local Road (< 800 vpd)	125mm GAP 40	100mm NZTA M/4 AP40	(ESAs 250,000)
Local Road (800 – 3000 vpd)	125mm GAP 40	125mm NZTA M/4 AP40	(ESAs 500,000)

These typical designs are based on an insitu subgrade having a soaked CBR of 15 over the full depth. If the insitu subgrade does not achieve this strength then it may be improved by undercutting to a minimum depth of 600mm and replacing with an imported subgrade of pit sand, brown rock or other material supplied then compacted to achieve the required CBR value.

If a subgrade of 600mm depth and CBR 15 is not practicable, a specific design will be required as per 3.2.12.1 i) Specific Design.

Unsealed Pavements

Unsealed pavements shall be compacted with a minimum compacted thickness of 300mm of well graded granular material with a minimum soaked CBR of 20. The maximum particle size shall be no greater than 100mm. This pavement material shall have sufficient fines to ensure that it does not unravel under the action of traffic. A material typically used on district unsealed roads is a high grade granular rock but will vary depending on locality. A 50mm minimum compacted thickness wearing course shall then be constructed using GAP20. The standard camber of unsealed pavements shall be 1:20-1:17.

3.3.13 Road Surfacing

All carriageways must be surfaced with either a chip seal or asphaltic concrete, but must be consistent with adjoining surfaces. Interlocking block paving or concrete will be considered on a case by case basis, the final surfacing type to be approved by Council.

Asphaltic concrete (type to be approved by Council) is required on industrial roads, roundabouts, urban arterial roads, all cul-de-sac turning circles and any other site subject to high turning movements. On cul-de-sac heads, asphalt shall be applied until the carriageway becomes a constant width.

3.3.13.1 Chip Seal Surfacing

The first coat shall be a two coat 3/5 chip seal for most residential roads. A further coat of chip seal must be applied between 3 and 18 months later as part of the project cost. If the second coat seal is going to be applied more than 12 months later, the defects liability period will need to be extended. Other chip seal designs may be considered and approved by Council.

3.3.13.2 Asphaltic Concrete Surfacing.

Asphaltic Concrete may be used as an alternative surfacing to Chip Seal. There are stricter requirements for pavement stiffness if asphalt is to be used. Selection of an appropriate mix for arterial and industrial sites is to be agreed with Council. For further details and requirements see clause 3.4.7.4.

Alternative asphaltic concrete products, such as Stone Mastic Asphalt (SMA) or Open Graded Porous Asphalt (OGPA), may be used with Council approval.

3.3.13.3 Concrete Block Paving

Concrete block pavers shall not be used without specific approval from Council. The concrete block pavers shall comply, and laying shall be in accordance with, NZS 3116 'Concrete segmental and flagstone paving'.

Pavements in NZS 3116 titled 'Light vehicular' are not acceptable for road surfacing.

3.3.14 Road Drainage

3.3.14.1 General

All roads shall be provided with facilities for the collection and disposal of both stormwater and subsoil water suitable to cope with the stormwater level of service for the area. Refer [Stormwater Section 4](#) Table 4.7. Designs shall consider the following factors:

- a) Groundwater recharge through soakage systems
- b) Quality of water discharged to receiving environments either directly or via connection to an existing piped network
- c) Requirements of the Waikato Regional Council
- d) Overland flow paths. Generally urban and industrial roads should be lower than adjoining land and rural roads higher than surrounding farmland.
- e) Water discharged from adjoining land (including current and future land use)
- f) Public safety
- g) Minimising of future maintenance requirements
- h) Capacity of any existing piped network
- i) Cyclists
- j) Reduction of peak discharge rate
- k) The depth of water in secondary flow paths should not exceed the flotation depth of vehicles of 150mm (see Clause 3.2.14.8).

3.3.14.2 Kerb and Channel, Vertical Kerb and Island Kerb

All profiles are to be founded on the subgrade with a CBR of at least 15. Where pavement depth is greater than 150mm, the profile shall be laid on a minimum of 75mm of compacted GAP40. For kerbs with tight radii (<5 metres), or carriageway narrower than standard, 'Heavy Duty Kerb and Channel' shall be used. Refer to [Drawing D3.3.3](#).

Urban Roads

- a) Kerb and channel shall be provided on both sides of the carriageway in all urban areas unless swales and raingardens are proposed. Refer Clause 3.3.14.11. Kerb and channel will only be required on one side of the road with a single crossfall.
- b) Mountable kerb and channel is not permitted in built up areas
- c) Subsoil under-channel drains shall be provided along kerb lines including medians, roundabouts and traffic control islands as shown on the [Drawing D3.4.1](#) except where it can be demonstrated that they are not necessary (e.g. where the underlying soil has a high porosity or at high points in the topography)
- d) Additional subgrade drainage may be required

Industrial Roads

Any road, street or lane constructed within an industrial zone (as specified in the relevant District Plan) shall be designed to meet the geometric standards for arterial roads, and incorporate industrial kerb and channel in accordance with [Drawing D3.3.3](#).

Rural Roads

- a) Kerb and channel shall be required where necessary to control stormwater runoff. Generally it may be considered for construction adjoining cut and fill batters to control potential scouring of the water tables and embankments.
- b) Subsoil drains shall be installed adjoining all cut batters.

Refer to [Drawing D3.4.1](#).

3.3.14.3 Dish Channels and Depressed Kerb and Channel

Dish channels are not to be used in carriageways. Where drainage is required for bus or parking bays a depressed kerb and channel should be used. The design profile should be the same as Commercial Channel Crossings, shown on [Drawing D3.3.2](#).

For dish channels within footpaths or accessways, these are to be founded on subgrade with a CBR not less than 7. Refer to profiles in [Drawing D3.3.3](#).

3.3.14.4 Slot Drains

Slot drains are not to be used in greenfield developments. However they may be accepted for use in brownfield areas. The use of surface channels and catchpits is more desirable. Slot drains can be used to cater for vehicle break over angles. Refer to [Drawing D3.3.7](#).

3.3.14.5 Catchpits

Catchpit spacing and location shall be designed to the following criteria:

- a) Catchpit spacing is to have a:
 - (i) Maximum gross area drained (carriageway, berm and footpath) = 900m²
 - (ii) Maximum area of carriageway drained = 450m²
 - (iii) Maximum of = 90m
 - (iv) Maximum where stormwater from private houses connect to kerb and channel = 60m

- b) Preferred location of catchpits:
 - (i) At intersections, at the kerb line tangent point
 - (ii) Upstream of pedestrian crossing points or cycle crossing cutdowns
 - (iii) At changes of gradient on steep roads
 - (iv) Cul-de-sac heads
 - (v) Mid lot, to avoid vehicle and pedestrian crossing points or cycle crossing cutdowns.
- c) A double catchpit is required:
 - (i) At the lowest point in a sag vertical curve
 - (ii) At the ends of a cul-de-sac where water falls to the end
 - (iii) On all channels where the gradient is steeper than 1:20.
- d) Catchpits in swales require a specific design
- e) Catchpit grates will be cycle-friendly designs as per [Drawing D4.8](#).

Catchpits shall be of the type referred to in the [Stormwater Section 4](#) (Clause 4.2.10).

3.3.14.6 **Batter Drains**

Batter drains shall be located outside of the transport corridor. Refer to [Drawing D3.4.1](#).

3.3.14.7 **Subsoil Drains**

Unless specified otherwise or agreed to by Council, piped subsoil drainage shall be provided to protect road formations from deterioration or loss of strength caused by a high water table and as part of swale stormwater systems. Design shall be in accordance with NZTA specifications F/2 and F/5. Refer to section 3.3.19.3 of NZS4404 for more details.

All piped subsoil drains shall discharge by gravity into a suitable component of the public stormwater system or approved discharge point.

For typical details of subsoil drains see [Drawing D3.4.1](#).

3.3.14.8 **Sub Drain Outlet**

Subsoil and batter drain outlets shall be to catchpits or manholes.

In rural situations, where no catchpit is available, the outlet shall be anchored.

3.3.14.9 **Side Drains and Water Tables**

Rural roads shall have normal crossfall to side drains/water tables formed on each side of the carriageway except where the road is on embankment above adjacent land without available formed drains. In such cases, the road may be designed so as to provide for sheet run-off to the adjacent land surface provided natural pre-existing drainage patterns are not altered.

For all situations where side drains are required they shall be sized to suit the flows discharging to them. Side drains shall be intercepted at regular intervals and discharge via open drains or pipes to an appropriate discharge point. All discharge points shall

have outlets protected from scour and shall be located to minimise the risk of slope instability.

The discharge of stormwater shall not be allowed to cause damage to the receiving property. The discharge of concentrated stormwater shall be in a 'secondary flow path' easement and be subject to the approval of affected property owners. Natural or non-concentrated stormwater shall be shown to be neither diverting catchments nor significantly changing peak flows or flow patterns.

Where side drains and water tables can't safely channel the stormwater flows, kerbs will be required.

3.3.14.10 Secondary Flow Provisions

At all points where sump blockage may occur or where design capacity may be exceeded, which could lead to overflow into private property, the provision of designed secondary flow paths protected by public ownership or easement shall be made. Refer to [Stormwater Section](#).

The design of roads that facilitate stormwater overland flow within the carriageway require a design methodology that does not result in ponding areas greater than 150mm deep in a 2% ARI. For more information on overland flow path design, refer to [Stormwater Section](#), clause 4.2.3.4.

The stormwater design for developments may use the road as a secondary flow path and therefore requires to be designed for 1% ARI.

3.3.14.11 Swales and Stormwater Sensitive Discharge Techniques

Berms, swales, rain gardens, and other low impact stormwater sensitive discharge shall be of a sufficient width to allow for adequate growth any plants and ease of maintenance, refer to [Stormwater Section](#) for specific guidance on stormwater devices

Stormwater devices are to be located in the berm area. The berm must be of sufficient width to accommodate the devices, utility services (if needed), plant growth and to allow for maintenance. Unless specifically approved by Council, swales shall not be located in the centre of the road.

It is essential that swales in urban areas are carefully designed so that they do not detract from amenity values and can be readily maintained.

Vehicle, pedestrian and cycle crossing points need to be defined and provided for as part of the swale design and construction. Consideration should be given to provision of traversable side slopes for safe passage of errant vehicles in the event of a crash.

3.3.14.12 Road Culverts

Catchment discharge shall be designed in accordance with the Stormwater Section and any applicable Regional Council rules and consent conditions.

Refer to the NZTA's Bridge Manual (SP/M/022) for waterway design at bridges and culverts.

All culverts parallel to the road shall have compliant traversable culvert safety ends installed to eliminate culvert end and headwall snagging hazards. Refer to NZTA Specification M23 : Road Safety Hardware (including interim acceptances).

3.3.15 Parking

3.3.15.1 General

The transportation corridor should be designed to accommodate the parking requirements contained in the relevant district plan. Alternative widths and layouts may be suitable where provision for parking in defined areas is clear of the through traffic.

Where on-road cycle lanes are immediately adjacent to this parking/passing area, additional width shall be provided in accordance with the NZTA Cycling Network Guidance – planning and design.

Parking bay pavement shall be constructed to the same standard as the road. Crossfall requirements are the same as for the carriageway.

3.3.15.2 On Road Parking - Transportation Corridor

The provision of on road parking is valued by motorists. For the parking requirements of a given road corridor, refer to the relevant district plan.

See [Drawing D3.1.8](#) for the layout of road parking areas. Parking provisions for motorcycles shall be considered in areas where activities in adjacent properties are likely to generate high on-street parking demand for this type of vehicle.

For inset parking bays, the minimum radius for the kerblines in the parking area shall be 5m.

3.3.15.3 Cul-de-sac Parking

To facilitate a clear movement lane, indented parking bays and parking in the middle of cul-de-sac heads may be considered.

3.3.15.4 Mobility Parking

Mobility parking spaces shall be designed according to NZS 4121: Design for Access and Mobility – Buildings and Associated Facilities.

A pedestrian cut down immediately adjacent to the mobility parking space shall be provided to facilitate safe and easy egress to and from the footpath.

Mobility spaces shall have a blue coloured surface and have the required line marking to define the space in accordance with the specifications set out in section 3.3.22 and in [Drawing D3.9.4](#).

3.3.16 Footpaths, Pedestrian Accessways and Walkways

Footpath provisions are contained in the relevant district plan or in the absence of detail refer to Table 3.2 NZS 4404.

3.3.16.1 Location, Width, Crossfall and Grade

Except where otherwise allowed for in the relevant District Plan, footpaths shall be provided on both sides of the road and located in the centre of the berm. See [Drawing D3.1.3](#).

Footpaths shall have the minimum clear width between obstructions such as signs and service poles.

In locations with high concentrations of pedestrians (e.g. shopping areas, outside schools and leading to schools, hospitals, halls or other places of public assembly) footpath widths require specific design in consultation with Council. Additional width may be required where angle parking adjacent to the footpath is anticipated.

Footpath crossfall shall typically be 1:100 sloping towards the kerb and channel. Localised footpath crossfall in the range of 1:50 to 1:33 may be permitted where levels make the typical crossfall impractical. Crossfall on footpaths in high pedestrian use areas such as shopping centres should be 1:100 or less.

Where footpath gradients are steeper than 1:12, a non-skid surface shall be provided. The maximum gradient for any footpath shall be 1:8; otherwise alternatives such as a “zig zag” will need to be used. Where gradients are between 1:12 and 1:8 and exceed 9 m in length, then a 1.2 m square flat section shall be provided at 9 m (maximum) intervals.

Footpaths shall not be depressed or raised by vehicular crossings³ unless adjacent to the kerb – refer [D3.1.4](#). Footpaths shall have a continuous surfacing treatment across the vehicle crossing.

New footpaths shall be constructed in concrete unless specified otherwise in a plan, strategy, policy or other document endorsed by Council.

No coloured additives shall be used.

3.3.16.2 Pedestrian Cut-downs

Pedestrian cut-downs shall be provided at all road intersections and pedestrian crossing facilities. The crossings shall be sited to facilitate desirable pedestrian, wheelchair and mobility scooter movements across the road and where possible drainage facilities shall be sited to reduce the flow of stormwater in the channel at the crossing entrance.

Pedestrian cut downs shall satisfy the NZTA Pedestrian Planning and Design Guide with particular care taken to ensure:

- a) There is no vertical up stand at the face of the kerb and channel within the pedestrian cut down
- b) Longitudinal and transverse gradients of the footpath and road adjacent to the pedestrian cut down are minimised in order to facilitate ease of access by users – especially for those in wheelchairs
- c) Break over angles for mobility devices through the crossing point do not create facilities that are unsafe for or not traversable by these devices. Refer to Drawings [D3.3.2](#) and [D3.6.2](#)

3.3.16.3 Pedestrian Accessways

Accessways may be provided to link one road to another in order to improve pedestrian and cyclist access. These are to be provided as a last resort where they cannot be eliminated through revised road layouts. They are not a substitute for good design.

³ The crossing area must be built to the appropriate crossing specification.

Pedestrian accessways shall be designed in accordance with NZS 4404 Section 3.3.11.1. In addition, they shall also include:

- a) A sealed shared footpath/cycleway that is a minimum of 3.0 m wide
- b) If it is necessary to incorporate steps into the access way, a ramp shall also be provided that is suitable for use by wheelchairs, mobility scooters and cyclists. Refer 3.3.16.1 for grades appropriate to these users.
- c) Barriers may be required to manage speeds and potential conflict points.

3.3.16.4 Walkways

Rural residential subdivisions should make provision for pedestrian access along grass berms.

3.3.17 Facilities for Vision Impaired Pedestrians

Facilities for visually-impaired pedestrians (i.e. TGSI - tactile pavers) shall be installed in accordance with the NZTA Specification RTS14 : Guidelines for Facilities for Blind and Vision-Impaired pedestrians at:

- a) Crossing points at Arterial or Collector Roads, including pedestrian throat islands, refuge islands and median islands
- b) Other points where significant numbers of pedestrians cross an access way or side road
- c) Railway crossings
- d) Signalised intersections and signalised pedestrian crossings
- e) Zebra crossings
- f) Other areas of high pedestrian activity such as shared zones, pedestrian malls, shopping centres and bus stops

Refer [Drawing D3.6.3](#) for minimum requirements.

3.3.18 Cycle Facilities

Cycling facilities shall be provided in accordance with the relevant district plan, and on any other route identified in a structure or other cycling plan as part of a primary or secondary cycling route. Such facilities may be a marked on-road cycle lane, a shared off-road cycleway/footway or a dedicated cycleway.

Provision for cyclists should be in line with Austroads Guide to Road Design, Part 6a: Pedestrian and Cycle Paths and the NZTA Cycling Network Guidance.

Off-road facilities designed for use by cyclists, either exclusively or shared with pedestrians shall have a minimum width in accordance with the relevant district plan, if appropriate. Off road cycle ways or shared paths shall have a maximum gradient of 1:8, and have a minimum lateral clearance of 700mm and minimum overhead clearance of 2.5m from any fixed object (including trees).

Cycle lanes or cycleways shall be surfaced with either concrete or asphaltic concrete. Interlocking block pavers are not suitable for cycling except as entry treatments or similar short lengths.

On road cycle lanes shall be marked to NZTA's Traffic Control Devices Manual and Drawings [D3.9.1](#) and [D3.9.2](#).

3.3.19 Vehicle Crossings/Entrances

3.3.19.1 General

The vehicle crossing design must allow vehicles to use the crossing without scraping while preventing stormwater entering the vehicle crossing/driveway from the street.

3.3.19.2 Residential Vehicle Crossings

The crossing shall be shaped to prevent stormwater from the road running down the driveway onto private property. No water from an adjacent property shall be allowed to discharge across the berm to the carriageway. A freeboard of 200mm shall be provided (i.e. height above the channel or pavement edge) to contain stormwater on the road unless it can be shown that such a condition is impractical and stormwater will not enter property vehicle crossings/driveways as a result.

Vehicle crossings shall be provided between the edge of the carriageway and the road boundary at the entrance to all private ways, lanes and to any lot at the subdivision or development stage.

Where there are multiple access points at the subdivision or development stage, crossings shall be left to be constructed at the building consent stage.

The number and location of vehicle crossings shall be in accordance with the requirements of the relevant District Plan.

Vehicle crossings shall be designed to enable the 99th percentile car to use them to ensure break over angle does not cause grounding any part of the vehicle. Refer NZTA Traffic Note 48 Light Vehicle Sizes and Dimensions - street survey results and parking space requirements. Also refer to [Drawing D3.3.1](#).

Pavement design shall be adequate to carry the expected load over its design life, including heavy vehicles during construction. Refer Drawings [D3.3.2](#) and [D3.3.5](#).

Vehicle crossings shall be designed in accordance with the NZTA's Pedestrian Planning and Design Guide to accommodate the needs of pedestrians such that the footpath is continuous through the site (Refer to [Drawing D3.3.1](#)). Vehicle crossings shall not interfere with the profile of the footpath or the berm except that minor filling may be permitted between the property boundary and the footpath. Retaining walls or structures are NOT permitted to encroach onto the berm and no lowering of the berm is permitted.

Vehicle crossings shall be surfaced with concrete or asphalt to match the adjacent footpath surfacing. Where there is no existing footpath the crossing may be surfaced with either concrete or asphalt. In all cases, a construction joint shall be provided at the property boundary.

The crossfall of the vehicle crossing shall be towards the kerb and channel.

Any redundant vehicle crossing to a property will be removed at the time of constructing a new entrance into that property.

3.3.19.3 Commercial and Industrial Vehicle Crossings

All lots in areas zoned for commercial or industrial activity and all developments in other zones for commercial or industrial activities must have an industrial standard crossing. Dimensions and construction details are provided in [Drawing D3.3.2](#) and [D3.3.5](#)

For wide commercial vehicle crossings in areas of moderate to high pedestrian use, consideration shall be given to reinforcing the priority of the footpath over the crossing. Use of different surfacing types and colours or other measures may be appropriate.

3.3.19.4 Rural Vehicle Crossings/Entrances

Vehicle crossings shall be provided between the surfaced road edge and the lot boundary at a defined and formed access point to every rural lot. The design should ensure that uphill entrances are not graded towards the edge of seal and flush debris on to the road and create a danger to cyclists and motorcyclists. The crossing shall be sealed to the road boundary and to a standard not less than that of the adjacent road surface. If the access slopes up from the road the crossing shall be sealed to a minimum distance of 10m from the edge of the carriageway.

The design, including visibility and sight lines, shall be in accordance with NZTA Guidelines RTS 6. If traffic volumes entering or exiting the driveway exceed 40 HCV per day, or HCV's represent more than 1:5 of the vehicle manoeuvres, or the location of the driveway is affected by vertical geometry (i.e. located near the crest of a curve), then specific design will be required to demonstrate that the driveway is located such that the safe operation of the adjacent road is not affected. See [Drawing 3.3.4](#) for dimension and construction details

The crossing shall not obstruct any drainage facilities within the berm. Where the drain is shallow and only carries low rain flow, the crossing may pass through the drain. Where the drain is of an unsuitable shape or carries significant rain flow the drain shall be piped under the crossing.

Pipes and end treatments shall be sized appropriately for the catchment intercepted but shall be a minimum of 300mm diameter with compliant traversable culvert safety ends to minimise safety risk eliminate culvert end and headwall snagging hazards. Refer to NZTA Specification M23: Specification for Road Safety Hardware (including interim acceptances). The drain may be moved closer to the boundary to allow the vehicle crossing to be shaped as necessary to ease access into and out of the adjacent property. Rural crossings shall be designed so that access is available for the largest vehicle that is likely to access the site and for the control of stormwater and debris run-off.

3.3.19.5 Bus Stops and Shelters

Bus stops shall be provided on all bus routes, both existing and planned. The bus routes are determined by the Waikato Regional Council, Public Transport Unit. During the design phase, the location and design criteria for bus stops shall be confirmed with the relevant Council and the Waikato Regional Council Public Transport Operations Manager.

Bus stops and shelters shall be designed to NZTA Guidelines for Public Transport and Infrastructure and Facilities, with the following amendments or emphases.

Numbering refers to clause numbers in the ARTA document.

Table 3-7: NZTA Guideline amendments or emphases

2.1.2	Bus bays shall cater for 13.5m buses. Articulated buses are not currently in use in the Waikato. Appropriate road use controls shall be applied to allow buses to move safely and conveniently into and out of the stop such that the bus can stop parallel to and close to the kerb.
2.2	All bus stops shall be fully accessible. New bus stops shall have a kerb height between 150mm to 180mm at lip of channel above the road surface, over the full length of the bus stop. The kerb height shall allow the ramp from the bus to sit at a grade of 1:12 (max). Existing bus stops shall be progressively improved to meet the requirement.
3.2	New bus stops shall be sited such that houses along the route are within 400m of a bus stop.
4.1	Litter bins are required only at 'signature' stops
	Real time information displays are to be mounted on a separate pole.
	'Standard' type bus stops shall be used on the outward journey where there is no Orbiter route transfer or stop.
	'Regular' type bus stops shall be used on the inward journey and where there is an Orbiter route transfer or stop.
	'Signature' bus stops shall be used at very high usage locations as determined by Council
4.4	The bus stop sign shall be attached to a standalone pole with the RP-5 parallel to the road and a supplementary sign perpendicular to road (facing the pedestrian).
	If a bus stop pole is being installed on the Orbiter route, a 2.4m pole shall be installed to cater for the Orbiter sign (supplied by WRC).
	Signs must be located sufficiently back from the kerb line to avoid being hit by a bus and in a location to avoid nuisance to footpath users and bus patrons.
4.4	Bus shelters shall be installed at all inward bus stops and all Orbiter journey bus stops. Priority for installation of shelters at existing bus stops includes:
	Number of users per day.
	Use by vulnerable users (school children, elderly or those with wheelchairs or mobility scooters).
	Exposure to weather elements (rain, wind, sun).
	The shelter design including size, shape, location and materials shall be as agreed with Council. Generally, shelter colour shall be consistent with existing shelters. See Drawings D3.8.13 , D3.8.14 and D3.8.15 .
4.4	Seats and leaners shall be provided where appropriate at the direction of Council.
5	Bus stops shall have a suitable bus tracking path into and out of the bus stop. Desirably, an 18m entry taper and 9m exit taper. These areas cannot have vehicles parked in them at any time, but can consist of intersections, driveways, crossings and cycle lanes.
5	Bus boarders (half and full) should be considered in circumstances where parking is in high demand, speed limit is at or below 50km/h or where traffic calming measures are deemed desirable.

3.3.20 Road Lighting Design

3.3.20.1 Introduction

This section sets out the requirements for the design, construction, approval, auditing, upgrade and maintenance of the Council's road lighting network.

The Council recognises that the correct level of road lighting is important for the safety and well-being of the community and this document provides the guidelines to achieve the following elements of good lighting design:

- Enable safe and convenient movement of vehicles, pedestrian and cyclists
- Minimise glare, spill lighting and sky glow
- Reduce likelihood of criminal activity at night using CPTED principles
- Reduce energy consumption
- Reduce maintenance cost

This document represents the minimum standards that are acceptable to Council. It is a requirement that any new lighting installations shall:

- Meet the minimum performance standards referred to in this document
- Provide lighting to meet the requirements of AS/NZS 1158 Series.
- Recognise the need to maintain the level of lighting within design levels at minimum cost.
- Utilise equipment that will be available for the foreseeable future such that replacements and spares will be readily available.

These guidelines are not meant to provide a template for the physical road lighting design, but rather to identify and help to meet the design objectives related to the implementation of energy efficient lighting and effective maintenance processes. They are supplementary to the standard AS/NZS 1158 : Lighting for Roads and Public Spaces. Where a conflict exists between any Standard and the specific requirements outlined in this document, the Designer shall seek clarification from the Council.

All new lighting will be LED.

3.3.20.2 Specifications, Regulations and Codes of Practice

The work shall be undertaken in compliance with all statutory requirements including and not limited to the relevant standards and other documents listed in Clause 3.1.2.

3.3.20.3 Scope

Road lighting shall be provided on all urban roads (walkways/cycleways) and service lanes that are, or will be, under the control of the Council. See 3.3.20.18 for walkway/cycleways.

All lighting shall be designed and installed in accordance with AS/NZS 1158.

Designs shall use equipment and materials as noted in this document to ensure whole of life costs for Council are kept to a minimum.

3.3.20.4 Design Brief

In general new lighting shall blend in with adjacent road lighting, complement the neighbourhood character and, as far as is reasonably practicable, minimise the impact on the neighbouring properties and environment with regard to aesthetics, glare and spill light.

In rural areas where design speeds are greater than 80 kph, slip-base frangible approved lighting columns shall be used.

3.3.20.5 Designer

The lighting design must be carried out by qualified and experienced professionals.

The Designer must:

- be conversant with AS NZS 1158 standard and this document
- have at least \$1m professional indemnity insurance
- provide a Design Statement

3.3.20.6 Lighting categories

Refer to the Council’s roading hierarchy in the District Plan (see Appendix A) has been correctly determined before proceeding with any lighting designs.

Category V (vehicles) is applicable to arterial roads (high volume of vehicular traffic) on which the visual requirements of motorist are dominant. It should also provide a safe environment for pedestrians/cycle traffic at night and discourage criminal acts. The lighting category shall be selected using the charts in AS/NZS 1158.1.1.

Category P (pedestrian area lighting) is applicable to:

- collector and local roads (road reserves)
- walkways
- cycle ways
- public activity areas
- outdoor carparks

The major purpose of Category P lighting is to assist pedestrians to orientate themselves and detect potential hazards. The lighting may also be used to discourage crime and the principles of “Crime Prevention through Environmental Design” (CPTED) should be considered. For example, the layout and design of urban areas can either discourage or encourage feelings of safety for users. Discouraging designs include poor lighting or dark narrow alleyways. Encouraging designs include well-lit footpaths and bus/train stops, open parks (observable from surrounding streets) etc.

The following table provides an informative guide to determine the road hierarchy. It shall be read in conjunction with AS/NZS 1158.1.1 and AS/NZS 1158.3.1 in order to determine the appropriate lighting category:

Table 3-8: Road hierarchy

ROAD HIERARCHY	TRAFFIC COUNT / ADT	LIGHTING CATEGORY
Arterial (Primary and Secondary)	>6,000	V1, V2, V3
Collector (Primary and Secondary)	3,000 - 6,000	V4

ROAD HIERARCHY	TRAFFIC COUNT / ADT	LIGHTING CATEGORY
Collector (Primary and Secondary), Industrial, Local (Access)	1,000 – 3,000	P3
Local (Access), Cul-de-sac	<1,000	P4

3.3.20.7 Energy Efficiency

The lighting design must maximise the spacing between columns by optimising mounting height, luminaire type and lamp output.

The following are guidelines for typical lighting schemes with satisfactory energy efficiency outcome. It is Council's expectation that the lighting designer will evaluate other elements of installation geometry and select the most energy efficient option.

Table 3-9: Guidelines for typical lighting schemes

LIGHTING CATEGORY	MOUNTING HEIGHT (M)	LED (W)	WATTAGE	WIDTH (M)
Cat P	6-8	20-60		18-24 (road reserve width)
Cat V	8-12	60-180		10-20 (carriageway width)

3.3.20.8 Column Location

Column location is subject to vehicle speed limit.

For residential areas, columns shall be located generally in accordance with the following criteria:

- Columns should be positioned in the grass berm, a minimum of 1m behind the front face of the kerb. All columns in a section of road shall have the same offset from the kerb
- Columns shall be sited on the boundary line between two properties and at least 1m clear of any driveway or accessways.
- In new subdivisions and developments, lighting column positions must be located first to provide the correct lighting levels in accordance with AS/NZS 1158. Only then should trees be located. Trees shall not be within 8m of any lighting column. This measurement is taken from the trunk of the tree.
- Column offset and location for intersections, bends, road humps and roundabouts is to comply with relevant requirements of AS/NZS 1158.
- Pole clearances from overhead low/high voltage conductors shall comply with requirements of NZECP 34.

3.3.20.9 Traffic Management Devices

Design the lighting of traffic management devices to support the purpose of the device and to meet the requirements of the relevant AS/NZS 1158 Standard for Category V or Category P lighting.

3.3.20.10 Pedestrian Refuge Islands

All mid-block pedestrian refuge islands are to be lit by dedicated lights if the current road lighting levels are not providing the required lux levels of the selected lighting category as specified in AS/NZS 1158.

Dedicated lighting for pedestrian refuge islands is shown on Drawings [D3.11.1](#) and [D3.11.2](#) and [D3.6.4](#).

3.3.20.11 Pedestrian Underpasses

Pedestrian Underpasses shall be lit to an appropriate 'P' lighting category. All luminaires shall be resistant to vandalism with an impact rating of IK08 or better. All wiring shall be concealed with no cabling in surface mounted conduits. Circuits shall be designed so that the underpass lighting provides a 24hour power supply independent of the street light circuit. LED lighting must be used.

3.3.20.12 Pedestrian Crossings

Pedestrian crossing lighting shall be designed to AS/NZS 1158, Part 4. Luminaires with specific photometric distribution must be used.

Belisha beacons or reflective orange discs and white supplementary floodlighting are required at all crossings.

The general layout of lighting for pedestrian facilities is shown on Drawings [D3.11.1](#) and [D3.11.2](#).

All pedestrian lighting poles specified to be 'fold-down' poles shall have the following:

- a) Hinge located 150mm from existing ground level
- b) Be electrically safe whilst folded.
- c) Latches and safety catch in accordance with [Drawing D3.12.2](#) (as for traffic signals)

A lockable switch to enable the lights to be operated during day time may be specified when school patrols are likely to operate at the pedestrian crossing.

3.3.20.13 Flag Lighting

Lighting of an isolated intersection on an otherwise unlit route with an AADT of >1000, shall be evaluated/designed in accordance with AS/NZS 1158 Parts 1.1 and 1.3, and NZTA Specification M30 Road Lighting guidelines. Additional consideration shall be given to roads that are designated for traffic detours from main highways.

3.3.20.14 Amenity lighting

Lighting for decorative purposes (e.g. up-lights, feature lights) is not permitted in new subdivisions.

3.3.20.15 Under verandah lighting

Where under-verandah lighting is a Council asset, the impact on such lighting shall be considered during any demolition or development work on the building shall be carried out in such way that existing under verandah lighting in the vicinity shall remain connected and operational.

As built drawings of new or altered connections shall be submitted to the Council. Any replacement of under verandah lighting will use LED fittings.

3.3.20.16 Private road lighting

Lighting on private roads or ROW is preferred, however will only be permitted if the luminaires are on a separate metered circuit and a charging agreement is set up with owners and a power supply company.

These lights will not be the Council's asset and the maintenance of these lights will be the owner's responsibility.

The installation of privately owned road lights will not be permitted on public road reserves.

3.3.20.17 Carpark lighting

For pedestrian safety and security, all outdoor public carparks must be illuminated in accordance with AS/NZS 1158 requirements for Category P.

3.3.20.18 Walkway/Cycleway lighting

The minimum requirement is a light at each end of the walkway/cycleway to illuminate the end sections. These lights can be located in the adjacent road reserves provided that they:

- a) Operate as a 'good neighbour';
- b) Are mounted at a sufficient height to prevent vandalism.

For walkways/cycleways that are not straight or fail to meet CPTED requirements, additional lighting will be required.

3.3.20.19 Design Drawings and records.

In order to demonstrate compliance and to allow accurate construction all engineering drawings and documents must show the following information:

- a) The extent of the works showing existing and proposed roads and pedestrian areas.
- b) Proposed and existing significant road features (e.g. kerbs, property boundaries, planting, trees, traffic management devices, bus stops, pedestrian refuge islands and driveway locations).
- c) The road lighting layout showing the following:
 - (i) Luminaire manufacturer, model and optic
 - (ii) Outreach length and tilt angle
 - (iii) Column manufacturer and type
 - (iv) Luminaire mounting height
 - (v) Column spacing
 - (vi) Column to kerb offset
- d) The lighting design details including:
 - (i) Design Statement
 - (ii) Computer calculations (LTP analysis information required by AS/NZS 1158)
 - (iii) Luminaire photometric data (in IES or CIE format) including their origin and maintenance factor

- (iv) If applicable, site visit records / notes regarding the vicinity of HV/LV overhead conductors
- (v) Manufacturers' warranty period

3.3.20.20 Design Life

Lighting equipment, including columns, outreach arms, luminaires, LED lamps and coatings, shall be new and shall have the minimum design lives as set out in NZTA Specifications M26 and M30.

3.3.20.21 Manufacturer's Warranty Period

Minimum required manufacturer's warranty period from the date of on-site installation shall be as set out in NZTA Specifications M26 and M30.

The warranty must be transferable to the Council upon vesting.

3.3.20.22 Approved Columns

For V (Arterial / Collector) category roads, all columns shall have the following:

- Galvanised, non-painted steel octagonal columns, compliant with NZTA Specification M26 and M26A.
- Either curved or elliptical outreach arms.
- A corrosion protective coating in ground sections, extending 100mm above the finished ground level.
- Be ground planted unless shear base installation is specifically requested by the Council.

For P category (Local roads), all columns shall have the following:

- A steel column; finish can be galvanised, black or Brunswick green.
- Comply with the relevant NZTA specification M26.
- Cost of the proposed column to be no greater than 2.5 times cost of equivalent galvanised steel octagonal column
- A lead-in time that is no greater than 6 weeks
- Have either curved or elliptical outreach arm. Arch type are not permitted (bracket attached to top of luminaire).
- An opening for access to control gear no smaller than 100x150 mm fitted with a suitable waterproof cover or door. The opening shall be positioned 500-1200mm above ground level. The cover shall be secured by tamper proof bolts.
- A corrosion protective coating in ground sections, extending 100mm above the finished ground level.
- Be ground planted unless shear base installation is specifically requested by the Council.

3.3.20.23 Approved Luminaires

Luminaires shall be of the LED type and shall comply with the requirements of NZTA Specification M30.

The Council will accept only luminaire units from the NZTA Specification M30 approved list which meet the following criteria:

- Lead-in time for luminaire is no greater than 6 weeks
- Lead-in time for spare parts is no greater than 3 weeks
- Maximum total weight is no greater than 12 kg
- Initial Lumen to system wattage ratio is 90 or greater
- Power factor shall be 0.9 or greater
- An adjustable tilt/mechanism of +5° or -10° in incremental steps of 5° is desirable
- 3000 Kelvin luminaires to be used on both P and V category roads. Note that this deviates from that specified in NZTA specification M30 but approval has been given by the NZ Transport Agency for their use.

Refer to M30 for the latest list of accepted luminaires.

3.3.21 Special Vehicle Lanes

Where special vehicle lanes are required, they shall have appropriate signage, road markings and coloured surfacing.

Special Vehicle Lanes include the following:

- a) Bus and electric vehicle lanes
- b) Transit lanes - urban
- c) High Occupancy Vehicle (HOV) Lanes
- d) Cycle lanes

3.3.22 Traffic Control Devices – Line Marking and Signs

The design shall incorporate all required road marking, signs, and other facilities appropriate to the place and link context. Local roads should be designed to minimise the need for traffic signs and marking.

Designs shall satisfy the Land Transport (Road User) Rule, Land Transport Rule: Traffic Control Devices 2004, associated NZTA Traffic Control Devices Manuals, NZTA Pedestrian Planning and Design Guide and NZTA Cycling Network Guidance – Planning & Design Guide.

All proposed road markings, signs and other traffic control devices shall be shown on the plans and approved by Council.

3.3.23 Feature Entrance Walls, Berm and Street Furniture

The designer is to ensure that the resulting visual impact of walls, structures, street art, street furniture etc achieve good urban design visual outcomes. Refer to the relevant District Plan and any relevant policy and structure plan documents; early consultation with Council is encouraged.

3.3.23.1 Street Furniture

Seats, litterbins and other street furniture shall be designed and placed in accordance with any requirements of Appendix C or D.

Furniture used shall be compatible with existing street furniture, unless an alternative is specifically accepted by Council.

3.3.23.2 Feature Walls

Feature Walls are not permitted within the transportation corridor.

3.3.23.3 Berm Furniture

With the exception of approved litter bins, seats, fences and bollards, structures or features which are not part of signage or traffic control are not permitted in the Transportation Corridor, unless as part of a structure plan or in accordance with any relevant Council arts or other policy. Prior to installation and design, consultation is required with Council to ensure safety of road users is not compromised.

3.3.24 Safety Barriers

3.3.24.1 Pedestrian and Cycle Barriers

Where a footpath or other public access bounds or is adjacent to a steep bank, wall, culvert or other such feature, safety barriers for pedestrian and cyclists are necessary. All barriers shall comply with the design requirements of NZS/AS 1657 : Fixed Platforms, Walkways, Stairways and Ladders - Design, Construction and Installation and, where relevant, the New Zealand Building Code, Clause F4.

3.3.24.2 Vehicle Barriers

Alternative engineering measures that improve the information that road users receive from the road environment shall be considered prior to the installation of a roadside barrier include, but are not limited to:

- a) Relocation or modification of hazardous objects
- b) Marking of hazardous objects
- c) Road geometry and pavement surface
- d) Pavement markings
- e) Reflective raised pavement markers
- f) Street lighting
- g) Permanent warning signs
- h) Chevron sight boards
- i) Frangible sight rails
- j) Ground modelling and planting

Where safety barriers for vehicles in urban areas are necessary, they shall comply with the design requirements of NZTA RTS 11: Urban Roadside Barriers and Alternative Treatments.

Where safety barriers for vehicles in rural areas are necessary, they shall comply with the design requirements in AS/NZS 3845 : Road Safety Barrier Systems.

3.3.25 Fencing

Refer to Clause 3.4.12 or [Landscape Section 7](#) for fencing requirement styles.

3.3.26 Trees and Landscaping

Refer to Landscape Section for details on trees and landscaping in transport corridor.

3.3.27 Structures and Underpasses

3.3.27.1 Bridges and Large Culverts

For any project where a bridge is proposed, the bridge concept plan must be discussed and agreed with Council before detailed design commences.

Bridges and culverts may require separate resource and building consents. All bridges and culverts shall be designed in accordance with the NZTA Bridge Manual (SP/M/022).

Particular features that are to be considered/covered in the design shall include, but are not limited to:

a) **Widths/lengths**

All bridges and culverts shall be designed with a width to accommodate movement lanes, cycle, and pedestrian needs of the road, in accordance with the relevant District Plan.

b) **Safety barriers**

The design of the structure shall provide for the installation and fixing of all suitable barriers to cater for the needs of pedestrians, cyclists and vehicles, including the interaction between the various modes.

c) **Batter slope protection**

All culverts shall have anti-scour structures to protect batter slopes, berms, and carriageways.

d) **Clearance over traffic lanes**

Where passing above traffic lanes, bridges shall have a full clearance height of 5.2m. The bridge shall be signed to highlight the maximum safe design vehicle height.

e) **Foundations**

All bridges and culverts shall be founded to resist settlement or scour. Abutments shall be designed to ensure bank stability and provide erosion or scour protection as applicable.

f) **Provision for services**

The provision of the structure for use as a service corridor shall be included in the design. This shall include consultation with utility providers to ascertain their current and future needs.

g) **Waterway design**

Refer to the [Stormwater Section](#).

h) **Inspection and maintenance**

The design shall include provision of any necessary access facilities to and within the structure in order to undertake inspection and maintenance activities.

i) **Provision for lighting**

All of the above features shall be documented in the Design and Access Statement submitted at the time of the Engineering plans.

3.3.27.2 **Pedestrian Underpasses**

Pedestrian underpasses may be required in locations where high traffic and risks to pedestrian safety has been identified and maybe required as part of a structure plan walking/cycling strategy/policy. Underpasses will be required to have adequate width and height and access provisions which allow full use of pedestrians, mobility scooters, wheelchair access, visually impaired pedestrians and cyclists. The Underpass is to have minimum internal dimensions of width 4m, and height 2.5m.

Underpasses will provide sufficient natural and artificial lighting so as not to create undesirable dark places, designs must take into account stormwater disposal, and pumping stations are not permitted due to on-going maintenance issues.

Careful consideration to visual design outcomes is required; the design of wing walls, underpass structure, stairs, ramps etc., is to result in good urban design visual outcomes and compliance with CPTED principles.

Pedestrian underpass walls to be painted in 'Hit Grey' or other colour required by the relevant Council, and lighting shall be in accordance with the requirements set out in clause 3.2.20.11 above.

3.3.27.3 **Retaining Walls**

Retaining walls which are located within the Transportation Corridor will likely require a building consent; retaining wall designs which have been undertaken by a suitably qualified engineer will be required.

3.3.28 **Traffic Signals**

Traffic signal installations are to be designed in accordance with Austroads Guide to Traffic Management Part 10: Traffic Control and Communication Devices.

Refer also to Section 3.7 Traffic Signals.

3.3.29 **Traffic Calming Devices**

In order to achieve the desired design speed environment, traffic calming devices may be required within the transportation corridor. The Austroads Guide to Traffic and The Traffic Control Devices Manual and NZTA Speed Management Guide – Toolbox and Appendices should be used to guide development of these devices.

Standard details are provided for the following devices:

- Roundabouts – mini asphaltic concrete [D3.10.1](#)
- Raised pedestrian ramp [D3.10.5](#) and [D3.10.6](#)

3.3.30 Over-Dimensional Vehicle Routes

The Council may specify over-dimensional vehicle routes in its transportation/traffic bylaws.

When completing any improvements or changes to infrastructure the clearance requirements for over-dimensional vehicles (and their loads) shall be taken into account. Reference shall be made to applicable standard and consultation undertaken with the Heavy Haulage Association to confirm appropriate provisions are provided.

3.4 CONSTRUCTION

This section covers the methods, specifications and materials to be used when constructing transportation assets.

3.4.1 Pavement Materials

Councils may have differing aggregate requirements and these will need to be confirmed prior to design.

All materials shall be approved by Council prior to their use.

3.4.1.1 Pit Sand

Imported sand used in the formation of the lower sub-base pavement, footpaths, shared paths and paved areas, shall be 'run of pit' sand, free of organic matter and well graded. It shall be made up of clean particles of silica or hard stone containing minimal silts, clays, and pumices. This also applies to the pit sand if used as imported subgrade for concrete work.

3.4.1.2 GAP Aggregates

The GAP aggregate shall comprise crushed aggregate and must be free of all non-mineral matter.

The crushing resistance shall be not less than 100 kN when the aggregate is tested according to NZS 4407 Test 3.10 'The Crushing Resistance of Coarse Aggregate under a Specified Load'. An aggregate shall be considered to have met the requirement if the sample produces less than 10 percent fines when loaded so that the specified peak load is reached in 10 minutes.

In this case, the test shall follow the standard method in all other respects. If the aggregate passes the test, it shall be reported as having a crushing resistance 'greater than (the load specified)'.

The aggregate shall have a quality index of AA, AB, AC, BA, BB, CA or CB when tested according to NZS 4407 Test 3.11 'The Weathering Quality Index of Coarse Aggregates'.

The sand equivalent shall not be less than 25 for carriageway pavement metal when the aggregate is tested according to NZS 4407 Test 3.6 'The Sand Equivalent'.

Where the GAP20 is to be used on the footpath the sand equivalent shall not be less than 25 when tested according to NZS 4407 Test 3.6 'The Sand Equivalent'.

Grading Limits

When tested according to NZS 4402 Test 2.8.2 'Subsidiary Method by Dry Sieving', or Test 2.8.1 'Preferred Method by Wet Sieving' where aggregates contain clay or other fine material causing aggregation of the particles, the grading of the aggregate shall fall within the respective envelope defined in Table 3-10.

Table 3-10: Gap Aggregate Grading Limits

TEST SIEVE APERTURE	PERCENTAGE PASSING		
	GAP 65	GAP 40	GAP 20
63.0mm	100		
37.5mm		100	
19.0mm	40-65	63-81	100
9.5mm		40-60	52-76
4.75mm		25-45	33-57
2.36mm		16-35	20-44
1.18mm		9-27	12-35
600 micron		5-20	7-25
300 micron	10 max	1-15	4-20
150 micron		10 max	12 max
75 micron		7 max	8 max

Grading Shape Control

The weight in each fraction shall lie within the limits defined in Table 3-11.

Table 3-11: Gap Aggregate Grading Fraction Limits

FRACTIONS	PERCENTAGE OF MATERIAL WITHIN THE GIVEN FRACTION	
	GAP 40	GAP 20
19.00 – 4.75mm	25-49	-
9.50 – 2.36mm	14.36	19.45
4.75 – 1.18mm	7-27	11-35
2.36 – 600 micron	5-22	6-26
1.18 – 300 micron	3-18	3-21
600 – 150 micron	1-13	2-18

3.4.1.3 Granular Rock Fill Material

This material is a non-specific rock aggregate intended for use as a subgrade improvement layer.

This subbase material shall have minimum soaked CBR of 20 and a nominal maximum size.

The material shall be suitably graded, moderate to highly weathered quarry rock with sufficient fines to aid compaction. A minimum of 10% by dry mass shall be unweathered (blue) material to ensure a level of durability.

The source of supply of all materials shall be nominated and the material shall be tested to ensure the CBR requirement can be achieved, and test results shall be provided.

The suitability of the material will be assessed on its grading, crushing and weathering resistance, and clay content relative to its use. Evidence of the material's suitability will be required for approval by Council prior to its use.

3.4.1.4 NZTA M/4

This material shall comply in all respects with NZTA M/4 specification.

3.4.2 New Pavement Construction

3.4.2.1 Subgrade Layer

Use of stabilisation additives in the subgrade is subject to specific design and council approval (see section 3.3.12) as follows:

- a) The subgrade layer shall be constructed to meet the requirements of the pavement design and NZTA's Specification F/1 : Earthworks Construction. Wherever possible, the natural insitu material shall be used in construction of the subgrade by implementing compaction or other methods of modification to meet the required subgrade strength. Where the insitu material is unsuitable to be used as subgrade, or is otherwise excluded from use, it shall be replaced by imported subgrade material. The imported subgrade material for the pavement shall be fit for purpose and shall be subject to approval by Council before use. Options may include 'run of the pit' sand, selected quarry run rock or other material approved by Council. The suitability of alternatives will need to be demonstrated.
- b) The subgrade material, whether insitu or imported, shall be compacted to a depth of not less than 600mm. It shall be placed in layers not exceeding 150mm (compacted thickness) and as close as practicable to optimum moisture content. The material shall be compacted to the specified CBR value. Measurement of CBR value shall be by CBR insitu tests or, in the case of non-cohesive material, by a suitable calibrated Scala Penetrometer test.
- c) For cohesive soils, the Scala Penetrometer test may be used as a measure of uniformity. Irrespective of the CBR and Benkelman Beam results, the standard of compaction shall not be less than 95% of the optimum dry density of the material as specified in NZS 4402 Test 4.1.1 or Test 4.1.3.
- d) The entire surface of the compacted subgrade shall be made smooth, firm and uniform, by blading, grading and rolling, approximating the crossfall required on the final surface. The reduced level of any point shall be within the limits 0mm above to 20mm below the designed or nominated level, as establish by stringing.

The surface shall be finished so that all points are within 15mm below a 3.0m straight edge laid at any point on the surface. See section 3.8.2 for testing requirements.

- e) Compaction shall cease if the material shows signs of excessive weaving or heaving and shall not recommence until the problem has been resolved.
- f) If the compaction of the subgrade layer does not meet the required criteria then the following options are available for consideration
 - (i) The Contractor may opt to carry out further compaction to achieve the required level of compaction, or
 - (ii) Council may choose to replace not less than 100mm compacted depth of the subgrade layer with subbase metal. Once compacted, the surface shall be trimmed to grade and retested to prove the required strength has been achieved, or
 - (iii) The Contractor may, subject to the approval of Council, opt to correct the non-compliance of the subgrade by means of one of the following remediation methods:
 - the use of geogrid and/or geofabric;
 - stabilisation of the subgrade;
 - stabilisation of the subbase aggregate;
 - stabilisation of the basecourse aggregate; or
 - a combination of the above.

It should be noted that approval by Council of the application of one or more of the above options does not relieve the Developer/Contractor of responsibility for attaining the required final pavement strength.

Note: extended exposure of the subgrade to wet weather causes degradation of the subgrade's performance, the entire surface of the subgrade should be protected to ensure it is smooth, compacted, firm and uniform.

3.4.2.2 Recovered Material

Recovered material may be specified for use as the subbase layer for the construction of a new pavement, subject to prior approval by Council.

Where recovered material is to be used and there is a shortfall, the recovered material shall be placed first with the imported aggregate to make up the shortfall placed on top, subject to suitable depths of each being achievable for effective compaction.

Recovered road pavement for reuse shall have a grading curve within or close to (+/- 3% at any sieve size) the grading of the specified sub-base aggregate.

Recovered material is to be reclaimed in such a way that no contamination with clay occurs.

No seal or asphalt from the old pavement shall be included in the recovered material to be used.

Other than the recovered materials consequential characteristics, the pavement layer shall be prepared as specified.

3.4.2.3 Subbase Layer

NZTA's Specification B/2 : Construction of Unbound Granular Pavement Layers shall apply except where modified by the following:

- a) The subbase layer shall be constructed to the final shape shown on the accepted Construction Drawings
- b) No subbase layer material shall be placed until the subgrade has been satisfactorily completed and approved by Council
- c) The reduced level of any point on the surface of the subbase layer shall be within the limits 10mm above to 10mm below the designed or nominated level as establish by stringing
- d) The surface shall be finished so that all points are within 15mm below a 3m straight edge laid at any point on the surface
- e) The subbase (and basecourse if applicable) beneath the kerb and channel must extend at least 400mm beyond the back of the kerb. See Drawing D3.1.1.

3.4.2.4 Basecourse Layer

NZTA's Specification B/2 : Construction of Unbound Granular Pavement Layers shall apply except where modified by the following:

- a) The basecourse layer shall be constructed to the final shape shown on the accepted Construction Drawings
- b) No basecourse layer material shall be placed until all previous pavement layers have been satisfactorily completed and approved by Council
- c) The tolerances and testing requirements as described in section 3.8.2.

3.4.3 Ripping and Cement Stabilisation

Construction of any stabilised pavement layers shall be in accordance with NZTA Specification B/5 : In-Situ Stabilisation of Modified Pavement Layers. Council approval is required for use of stabilisation techniques, see section 3.3.12.

3.4.4 Testing

The pavement layers shall be tested and each layer approved by Council before construction of subsequent layers begins. For details of the testing and tolerances required, see section 3.8.2.

3.4.5 Concrete Works

This section covers all concrete work for footpaths, shared paths, various kerbing, kerb and channel, catchpits and vehicle crossings. These shall all be formed to the dimensions shown in the Drawings ([D3.3.1](#), [D3.3.2](#), [D3.3.3](#), [D3.3.5](#) and [D3.3.7](#)).

3.4.5.1 Formwork

Where not covered in this specification, formwork shall generally comply with the requirements of NZS 3109.

Wherever necessary, formwork shall be used to support and confine the concrete and shape it to the required dimensions. Joints and linings shall be sufficiently tight to prevent loss of water from the concrete.

All timber for formwork shall be of an approved quality and type. For kerbs and channels formwork shall be ex 40mm material provided that 15mm timber or other suitable material may be used on short radius curves.

Formwork shall be of a sufficient depth to fully support all vertical faces. Where it supports exposed surfaces, formwork shall be long lengths dressed smooth on one face and both edges.

Timber strips for chamfers shall be machined all round to be true to shape and form and they shall be kept in good order. Alternatively the chamfer or bullnose may be formed with a specific floating tool or dressed fillets.

Steel forms shall be of approved design and shall be maintained in good condition. The joints between lengths shall be secured accurately during concreting to maintain a good line in the finished work.

Forms shall be designed to be easily removable without damaging the green concrete and shall be kept thoroughly clean and oil or wax dressed to prevent adhesion of concrete or rust staining. Forms for curved kerbs shall be brought to a true curve by springing the timber evenly.

The shape, strength, rigidity, mortar tightness and surface smoothness of re-used forms shall be maintained at all times. Warped or bulged timber is not permitted. Timber which has been used shall have the surfaces which are to be in contact with the concrete thoroughly cleaned and treated before being used again.

3.4.5.2 Concrete Mix and Proportions

Concrete mixes shall be proportioned to be workable, capable of being thoroughly consolidated by the means of compaction available and to provide the specified strength of concrete. The concrete may be either ordinary grade, high grade or special grade as defined in NZS 3109.

The concrete used shall be either mixed on the site or supplied ready-mixed. In every case, the concrete production shall be in accordance with NZS 3104 : Specification for Concrete Production.

The strength of concrete as defined in NZS 3109 shall be 28-day cured in-place minimum strength 20 MPa for all the above works.

3.4.5.3 Placing Concrete

The Contractor shall give due notice to Council of the time it is intended to place any concrete and no concrete shall be placed until approval has been obtained from Council.

Concrete shall not be placed on frozen ground nor shall it be placed in unfavourable conditions, which may be detrimental to the quality and finish of the concrete. Unfavourable conditions shall be deemed to include low temperatures (below 5°C with temperature descending, or below 2°C with temperature ascending), excessively hot, dry conditions, excessively wet conditions, or any conditions making it impractical to work and finish the concrete adequately.

Immediately before placing the concrete, the foundations shall be lightly dampened, and formwork shall be cleaned out. In all cases surplus water shall be removed before concrete is placed.

The concrete shall be placed so the coarse aggregate does not separate from the fines, and it shall be thoroughly worked and consolidated into all parts of the formwork, so that no voids or cavities are left. All concrete shall be handled from the mixer, or from the agitator truck mixer, to the place of final deposit as rapidly as is practicable, by methods which prevent segregation.

Unless otherwise approved, in no case shall more than 30 minutes elapse between discharge of concrete from the mixer/agitator truck and final placement. Under no circumstances shall partially hardened concrete be placed in the work.

Where a channel is finished with a sand/cement mortar coat, the mortar shall be placed within two hours of placing the concrete, provided that when hot dry conditions are prevailing, the allowable time shall be reduced to 1 hour.

If for any reason a delay of more than 2 hours occurs, an approved PVA bonding agent shall be used to ensure the mortar is adequately bonded to the concrete.

Before fresh concrete is placed upon or against any concrete which has already hardened, the surface of the hardened concrete shall be thoroughly scabbled, cleaned and cleared of all laitance, loose or foreign material.

3.4.5.4 **Reinforcement**

All reinforcement other than ties and stirrups shall be deformed unless otherwise detailed. The length of lapped splices (without hooks) shall be not less than 32 bar diameters in length.

Steel reinforcement, at the time the concrete is placed, shall be free from loose flaky rust, mud, oil or other coatings that will destroy or reduce the bond.

Reinforcement shall be accurately placed, adequately supported and secured against displacement before or during concrete placement.

The minimum cover to all main reinforcing steel shall be 50mm unless otherwise specified.

3.4.5.5 **Curing Of Concrete**

Strict attention shall be paid to adequate curing, which is an important factor in attaining the required strength for the concrete.

Immediately after placement, concrete shall be protected from premature drying, excessively high or low temperatures and mechanical damage and shall be maintained with minimal moisture loss for the necessary curing period and hardening of the concrete. In hot dry weather sprinklers or damp covers will need to be used.

All concrete surfaces not in contact with formwork shall be cured by the application of a curing compound conforming to the specification ASTM C309 : Specification for liquid membrane - forming compounds for curing concrete.

In cold or wet weather, concrete shall be protected from the elements during the curing period by covering with sheets of PVC or alternative approved material.

3.4.5.6 **Machine Laid Kerb and Channel**

Contractors who intend to construct the kerbs and channels by using an extrusion machine will be required to use ready mixed concrete from a certified plant. The concrete provided shall be designed so that after placement it will accurately retain its shape and present a good surface. Certification of the concrete supplied is required. No subsequent cement washing will be permitted. The machine shall be capable of providing well compacted concrete with the absence of trapped air.

The machine shall not be used to pour curves with radii less than 5m. For these curves the Contractor shall use formwork as specified.

A properly shaped screed shall be used in forming cut downs.

3.4.5.7 **Finished Work**

Methods shall be used that will provide a smooth, clean and even surface on the exposed faces of all concrete work. These methods shall also put the required finish directly on the structural concrete without the use of mortar renderings, provided that, if specific prior approval of Council is obtained, the channel may be finished with a layer of separately applied mortar. In such a case, the mortar shall consist of not more than 2 parts of approved sand to 1 of cement. It shall be nominally 6mm in thickness and shall be placed before the initial set of the concrete and within 2 hours of placing the concrete.

Alternatively, a mortar layer to the above consistency may be applied in conjunction with the laying of the kerb and channel if the kerb and channel is laid by machine and the machine is designed for such use.

The top and face of the kerb and the channel surface shall be floated over with a steel tool before the mortar has finally set. No depressions which may hold water will be permitted.

The surface finishes of all kerb and channel, whether machine laid or hand laid, shall be uniform in colour, texture and shape.

3.4.5.8 **Contraction/Expansion Joints**

Contraction/Expansion joints shall be formed or cut along the kerb at a maximum spacing of 3.0m. The slot shall penetrate the concrete by not less than 50mm and the mortar dressed over the cut face. The contractor shall ensure that cold joints are accurately marked so that the subsequent saw cut is in the cold joint. Should cracking occur adjacent to the saw cut a minimum section of 1.5 metres of kerb and channel shall be removed and re-cast.

3.4.5.9 **Backfilling against Concrete Work**

Backfilling against the kerb and channel or any other concrete structure shall take place as soon as practicable after the concrete has reached sufficient strength, with particular emphasis at curves, corners, intersections and pedestrian kerb crossings but not prior to 36 hours after pouring.

Care shall be taken to ensure that no damage is done to the path, crossing, kerb and channel or other concrete structure when placing and compacting the backfill.

3.4.5.10 Surface Finish (Footpath, Shared Paths and Vehicle Crossing Areas)

All final path and vehicle crossing surfaces shall be true to the lines and levels Specified and 'broom' finished. Design considerations aside, the final surface shall not vary by more than 5mm when checked with a 3m straight edge. No finished surface shall hold water.

3.4.6 Road Stormwater Drainage (Kerb, Channel and Catchpits) Construction

3.4.6.1 Kerb and Channel in Existing Pavement

Prior to work commencing, the lengths of kerb and channel that are to be removed shall be marked on site and agreed with Council.

3.4.6.2 Saw Cutting

Prior to removal, the kerb and channel shall be cut vertically and at right angles to the alignment to ensure a clean break. The existing sealed surface shall be cut parallel to and at a distance of 500mm, or greater if required, from the existing channel lip. The seal shall also be cut perpendicular to the kerb from the vertical saw cut to the parallel seal cut.

If the kerb and channel to be removed abuts any berm seal (e.g. sealed footpath), the sealed surface shall be saw cut within 5 days, at a distance behind the kerb face suitable for reinstatement. Refer [Drawing D3.3.6](#).

3.4.6.3 Excavation to Pavement Depth

After saw cutting, the kerb and channel and pavement shall be excavated to the proposed pavement depth or deeper if required. The sides of the excavated area shall be trimmed to be as near as possible to vertical. Care shall be taken to ensure that undermining and/or over break does not occur during excavation. All waste material including the old kerb and channel shall be removed from the site and appropriately disposed of.

3.4.6.4 Subgrade Preparation

The exposed subgrade (at the required depth), shall be tested using a standard Scala Penetrometer refer to section 3.8.3. The prepared subgrade shall be compacted to the CBR specified. If the material fails this initial test it shall either be:

- a) Further compacted, if the material is suitable, to improve the CBR value, or
- b) Excavated and removed from site, then backfilled with pitsand and compacted to the subgrade level.

All pitsand backfill shall be compacted in lifts of not more than 100mm. The subgrade area either insitu or imported shall be trimmed and shaped to accommodate the specified lines and levels given and compacted to provide uniform support for the pavement course.

All tree roots found in the subgrade or pavement area during excavation shall be removed (subject to Council Arborist approval) and are to be severed 0.5m behind the back or front of the kerb and be removed off site. Any root greater than 50mm in diameter shall be cleanly saw cut. No such roots shall be cut without the prior approval of Council if they are within the dripline of the tree.

Note: extended exposure of the subgrade to wet weather causes degradation of the subgrade's performance, the entire surface of the subgrade should be protected to ensure it is smooth, compacted, firm and uniform.

3.4.6.5 **Kerb and Channel Foundation**

After the subgrade has been approved, a compacted layer of GAP40 75mm deep shall be placed. Compaction shall be to refusal. The surface of the GAP40 shall be smooth and uniform, suitable for the placing of the kerb and channel concrete.

3.4.6.6 **Kerb and Channel Placing**

Refer Clause 3.3.14.2 for details on concrete placement.

3.4.6.7 **Joining to Carriageway**

After the kerb and channel concrete has reached sufficient strength, the carriageway shall be married into the existing carriageway (with banding) and new kerb and channel lip. If not already achieved during the kerb base construction, the carriageway shall be excavated to the existing subgrade and at least 200mm deep at the channel face. The excavation base shall be flat and level up to the edge of the saw cut seal. All excavated faces shall be vertical.

The subgrade shall be compacted to a CBR of at least 10. The basecourse metal (NZTA M/4 or GAP40) shall be placed on the prepared subgrade in layers not exceeding 150mm and compacted to refusal. The depth of basecourse is dependent on the surfacing, either asphalt or chip seal, but not less than 200mm (i.e. 25mm of asphalt surfacing).

3.4.6.8 **Kerb and Channel in New Pavement**

In accordance with clause 3.4.5.6, except all references to carriageway protection and reinstatement shall not be required for this activity.

3.4.6.9 **Catchpits**

Refer to [Stormwater Section](#) for details; the details also show a list of the permitted precast components.

The construction specification described in [Stormwater Section](#).

Catchpits shall be accurately positioned so that the grate and kerb block fit neatly into the kerb and channel. Rectangular pits shall be oriented with the longer side parallel to the kerb. Grates are to be cycle friendly.

3.4.6.10 **Subgrade Drainage**

Refer to [Drawing D3.4.1](#) for details. NZTA specifications F/2 : Pipe Subsoil Drain Construction and F/5 : Corrugated Plastic Pipe Subsoil Drain Construction shall apply.

Where subsoil drains are required, as shown on the Drawing or directed by Council, they shall be placed behind the kerb unless shown or directed to be in front of the kerb.

The subsoil drains shall consist of an approved filter drainpipe, 100mm to 150mm diameter, or equivalent, in a trench backfilled with an approved filter material around the conduit. The conduit shall have a grade not less than 1:200 to discharge into the catchpit.

3.4.6.11 Additional Subsoil Drainage

Where directed, any permanent wet spot in the subgrade shall be drained to the subsoil drain. Where the wet area is below the level of the subsoil drain, it shall be drained by connecting to the nearest stormwater system.

3.4.6.12 Other Requirements

NZTA F/2 filter material shall not be used as a filter material in close proximity to HDPE slotted pipe. Unless otherwise designed and approved by Council, pea-metal shall be for backfilling around HDPE slotted pipe. Where backfilling a subsoil drain with filter material the minimum cover shall be 100mm. Where a strip drain is approved, backfill is to be permeable sand.

The invert of subsoil pipes at the catchpit shall not be less than 100mm above the invert of the catchpit outlet.

3.4.7 Road Surfacing Construction

The relevant NZTA specifications listed in Clause 3.2.2 shall apply to road surfacing procedures and materials.

Exceptions to the specifications include:

- All references to the basis of payment contained within the specifications are deleted;
- Reference to the Contractor's obligation with respect to the foreshortening of the maintenance requirements of the seal coat (NZTA P/3 & P/4) is deleted;

Application rates, cutback percentage and the percentage of adhesion agent is to be specified by the Developer/Contractor, and forwarded to Council with design calculations for approval at least 24 hours prior to application.

For both first and second coat chip seal, the bitumen application shall extend over the lip of the kerb and channel, but not by more than 25mm.

3.4.7.1 Waterproofing First Coat Chip Seal

A two coat chip seal shall be applied to the prepared basecourse surface but only when the air temperature is greater than 10°C in the shade as detailed in the NZTA P/3.

The first layer shall consist of the supply and spraying of 180/200 penetration grade bitumen. The bitumen shall be cut back to suit, include one part per hundred (p.p.h) adhesion agent and be spread at a rate of 1.2 litres/m² residual (measured at 15°C).

The first layer chip shall include the supply, spreading and rolling of Grade 3 chip at a spread rate of 75 m²/m³. It is essential that the spreading of the first chip layer is carefully controlled such that the chips are evenly spread and are no more than one layer thick over the entire surface.

The second layer shall consist of the supply and spraying of 180/200 penetration grade bitumen. The bitumen shall be cut back to suit, include one pph adhesion agent and be spread at a rate of 0.8 litres/m² residual (measured at 15°C).

The second layer of chip shall include the supply, spreading and rolling of Grade 5 chip at a spread rate of 150 m²/m³.

Refer to 'Removal of Surplus Chip' in clause 3.4.7.3.

3.4.7.2 **Chip Seal Resealing**

This treatment shall be applied on carriageways to produce a uniform texture on surfaces that have an existing seal coat and potentially repair patches.

Prior to resealing all surfacing and pavement defects must be repaired. The resealing shall not be applied until 28 days after asphalt patching or levelling has been completed, or the basecourse repairs have been two-coat sealed.

The second coat chipseal carried out between 3 and 18 months after the waterproofing first coat shall consist of supply and spraying of 180/200 penetration grade bitumen. The bitumen shall be cut back to suit, include 1 pph adhesion agent and be applied at the rate of 1.3 litres/m² residual (measured at 15°C). The chip layer shall consist of the supplying, spreading and rolling of Grade 5 chip. If specified, a dry locking coat of Grade 5 or 6 chip shall then be supplied and applied at a rate of 300 m²/m³.

3.4.7.3 **Removal of Surplus Chip**

When the sealed surface is to be opened to traffic, all surplus chip shall be removed within 48 hours of the completion of rolling. For sites that are not open to normal traffic, chip sweeping may be delayed but must be completed before opening the road to normal traffic.

All surplus chips shall be removed from grass berms, driveways, parking areas and footpaths. Follow up sweeps will be required to ensure that all loose chip is collected and removed from the site for a period of one month following chip application.

3.4.7.4 **Asphaltic Concrete**

Where design traffic volumes in residential areas are less than 800 vehicles per day, and there are no additional turning stresses created by intersections, a single coat grade 5 membrane seal shall be used with a residual bitumen application rate of 1 L/m².

Where traffic volumes are higher or there are greater stresses, a waterproofing chip seal shall be applied to the prepared basecourse surface in accordance with section 3.4.7.1. The asphalt concrete shall be placed no sooner than 14 days after the application of the waterproofing chip seal.

Asphaltic concrete paving shall consist of the supply and spraying of a tack coat with a quick breaking bituminous emulsion at an application rate of 0.3 litres/m² and the supply, spreading and rolling of asphaltic concrete or an alternative mix as approved by Council.

For local residential roads with less than 800 vehicles per day and no additional turning stresses, the default mix is an NZTA M/10 DG10, with a minimum thickness of 25mm.

For residential roads with greater than 800 and less than 3000 design vehicles per day, or have greater stresses due to intersections the default asphalt design is an NZTA M/10 AC10, with a minimum thickness of 35mm.

For commercial/industrial roads, or those designed for greater than 3000 vpd a specific design must be approved by council.

The asphaltic concrete shall ramp to transition back to the adjacent existing surfaces as illustrated in [Drawing D3.5.2](#).

3.4.7.5 **Block Paving- Carriageway**

Bedding Course for Block Paving

All bedding course shall be laid in accordance with either Clay Paving Design and Construction or NZS 3116 : Concrete Segmental and Flagstone Paving and comply with [Drawing D3.3.5](#).

Laying of Paving Blocks

All paving blocks shall be laid in accordance with NZS 3116.

Edge Restraints

Refer to [Drawing D3.6.1](#) for details of the type of edge restraint.

Edge restraints shall be one of the following:

- a) Kerb and channel
- b) Traffic island kerb
- c) Concrete separating strip
- d) Paving blocks on edge cast in concrete
- e) Timber edging

All pavers must be cut using a power saw unless specified otherwise.

3.4.7.6 **Line Marking Reinstatement**

Line marking must be applied within 48 hours of applying surfacing, or in the case of chip seal within 48 hours of the surface being swept. If the road is not open to normal traffic, this may be delayed, but must be carried out before the road is opened to normal traffic.

A re-mark may be required prior to vesting depending on wear and deterioration of the markings.

3.4.8 Berms

Berms will typically be grassed, but may be landscaped if it is impracticable to maintain as grass.

All berms and landscape planting design and implementation within the road reserve shall be in accordance with [D3.1.4](#) and Clause 7.3 and 7.4 of the Landscape Section.

Berms that are to be grassed shall:

- a) Have a minimum subgrade of CBR 7
- b) Have a minimum compacted depth of topsoil of 75 mm
- c) Be seeded in accordance with the Landscape Section, Clause 7.3.6.
- d) Be free of debris and perennial weeds

Berms are to be mown during the defects liability period as well as prior to take over by Council.

3.4.9 Footpaths, Cycle Paths and Vehicle Crossings

This section outlines the work required to construct, reinstate or repair footpaths, vehicle crossings and away-from-road cycle paths.

3.4.9.1 Alignments, Lines and Levels

The edge lines of kerbs, footpaths, shared paths and vehicle crossings shall be perfectly straight between tangent points, and on curves shall sweep round without kinks, flats or angles in a smooth, true arc to the radius shown or directed.

Design levels and alignments shall be strictly adhered to and the grade from level peg to level peg shall be even, provided always that at changes of grade the angle between the grades shall be eased so as to form a vertical curve or other form of smooth transition. The entire berm area shall fall, at an even grade where possible, from the property boundaries to the kerb and channel.

3.4.9.2 Break out, Removal and Disposal of Existing Berm Features

All existing berm features that are to be removed shall be broken up and lifted out to reduce damage to the surrounding features. The outer limits of these features shall be saw cut, except in the case of paving blocks or grass verges, before removing to provide a tidy interface between existing and replacement work.

Where salvaging of materials (e.g. catchpits, gratings, frames, stormwater piping) is specified, care shall be taken to ensure that as little damage as possible is done to materials. Such units shall be neatly stacked on the site such that they do not obstruct any footpath, vehicle crossing or roadway until they are taken off site. All materials not for reuse shall be removed from site and appropriately disposed of.

3.4.9.3 Excavation to Pavement Depth

Excavation shall be to the pavement depth as shown on [Drawing D3.3.5](#).

The width of all excavation shall be no wider than necessary to construct or reinstate the various berm features.

Where excavation adjoins existing berm features or carriageways, care shall be taken not to undermine the existing surfacing while material is being removed. The sides of the excavated area shall be trimmed to as vertical as possible without being unstable or causing undermining.

3.4.9.4 Subgrade Preparation

The exposed subgrade (excavated to trial subgrade level or pavement depth) shall be tested by using a Scala Penetrometer for compliance with the following CBR values

- a) In footpath, cycle paths and traffic island infill CBR value >10 (4 blows per 100mm)
- b) In vehicle crossing and kerb and channel areas CBR value >10 (4 blows per 100mm)

If the material fails this test then:

- a) The existing subgrade shall be further compacted, to improve the CBR value; or if this is not practicable
- b) The unsuitable material shall be excavated, removed from site, replaced with pitsand and compacted up to the trial subgrade level

When undercutting of the subgrade is required (the second option above) the excavation depth and extent shall be instructed by Council. As a minimum, it is to extend 100mm past either side of the edge boards, or the outer limits of the construction area.

Note: Small pockets of material may require treatment rather than the entire subgrade area.

All pits and backfill shall be compacted in lifts of not more than 100mm. The subgrade area, either existing or reinstated, shall be trimmed, shaped and compacted to provide uniform support for the pavement course.

All tree roots found in the subgrade or pavement area during excavation shall be removed. They shall be severed at least 200mm outside the excavation area, removed from site and disposed of. Any root greater than 50mm in diameter is to be cleanly sawn. No such roots within the drip line of the tree shall be cut without the prior approval of Council.

Note: extended exposure of the subgrade to wet weather causes degradation of the subgrade's performance, the entire surface of the subgrade should be protected to ensure it is smooth, compacted, firm and uniform.

3.4.9.5 Timber Edging for Asphalt and Paving Block

All footpaths, cycle paths and vehicle crossing edges shall be contained by either a concrete kerb or edging, or by treated timber edge boards, which shall form part of the finished work.

Edge boards shall be held firmly in place with wooden pegs (50 x 25mm) or battens nailed to the outer edge at no greater than 1.0m centres and at every joining board. The pegs shall be a minimum length of 225mm or longer to be driven down into solid unyielding ground. Batter stakes may be used as pegs, driven down into firm ground and trimmed to the correct length. All pegs shall sit 15 to 25mm below the top level of the edge boards.

Edge boards shall be joined with 400mm long boards (either edge board offcuts or 75 x 25mm timbers) which span the joint evenly and are nailed firmly in place at the rear of the edge boards. The top of the joining boards shall sit 15 to 25mm below the top level of the edge board. The spacing of wooden pegs shall be adjusted so that a peg is positioned alongside every joining board. Refer to [Drawing 3.6.1](#).

All timber edging shall be backfilled outside the construction area as necessary to protect the timbers from being damaged or distorted during the preparation and compaction of the pavement course. All edge boards shall be set out using string lines and shall be true and straight at the completion of the work. All edge boards and pegs will use H4 or H5 treated timber.

If directed by Council, existing timber edging in good condition shall be adjusted for level, re-peged and incorporated in the new footpath or vehicle crossing. At all times,

excavation for timber edging replacement, installation or adjustment shall be the minimum required to provide adequate work space.

Where the path edge adjoins existing kerb, the top of the kerb shall be treated as the top of the edge board.

3.4.9.6 Pavement Basecourse

The pavement basecourse shall be constructed of bedding sand and/or GAP metal (NZTA-AP metal on occasions) and be compacted to a pavement depth conforming to the [Drawing D3.3.5](#).

For asphalt footpaths and cycle paths, the final pavement surface shall have a tight stone mosaic surface, with no loose aggregate, suitable for the application of a tack coat and an asphalt layer. A skin of GAP 20 may need to be added to GAP 40 areas and compacted into place to achieve this. All pavement courses shall be compacted to refusal in lifts of not more than 100mm.

3.4.9.7 Concrete Surfacing

Concrete surfacing shall be carried out in accordance with clause 3.4.5. Where concrete paths are to be constructed steeper than 1:10, a permanent non-skid surface should be provided (broom finish or similar).

For cross section detail refer [Drawing D3.3.5](#).

In concrete paths, crack control lines shall be formed or cut at vehicular crossing/footpath edges and along the path at a maximum spacing of 5.0m. All crack control lines shall be 25mm deep.

3.4.9.8 Asphalt Surfacing

The prepared pavement shall be swept to remove all loose metal and debris prior to the application of a tack coat. The tack coat shall be applied to all surfaces where the asphalt material will be placed and generally at an application rate of 0.25 litres/m². Asphalt Mix shall be laid to the compacted depths shown on [Drawing D3.3.4](#). The final surface shall be flush with the top of the edge boards and graded uniformly between. Depressions or irregularities that may cause water to pond will not be accepted in the finished surface.

All asphalt shall be laid in accordance with NZTA's Specification P/9 : Asphaltic Concrete Paving Construction, except that plant appropriate to the size of the area being surfaced shall be used.

3.4.9.9 Asphalt Overlay

Where asphalt smoothing or overlay is required, the existing surface shall be swept to remove all loose metal and debris prior to the application of the tack coat. Mix 5 asphalt shall be used to smooth irregularities up to a compacted depth of 20mm. Mix 10 shall be used to smooth irregularities up to a compacted depths of 20-50mm and Mix 20 shall be used for compacted depths of 50mm and greater.

3.4.10 Private ways

3.4.10.1 Urban

Concrete

For concrete pavements:

- The minimum depth of concrete is 125 mm for private ways serving two to four household units
- The minimum depth of concrete is 150 mm for private ways serving five to ten household units

Concrete is to be placed on a subbase of 75mm of compacted GAP20 on a compacted subgrade with CBR ≥ 10 . For subgrade criteria < 10 CBR, subgrade improvements are to be made to bring the subgrade strength up to a CBR of 10.

Other

Pavement may be interlocking block pavers. Refer to section 3.4.7.5 for specifications.

Stormwater shall not discharge across the vehicle crossing from the private way to the road. Vehicle crossings to private way shall be designed and constructed in accordance with clause 3.3.19 and [Drawing D3.3.1](#).

3.4.10.2 Rural

All rural residential private ways shall have:

- Pavement GAP40 minimum depth 150mm
- Subgrade minimum CBR 15 continuous over a depth of 600mm. For subgrade criteria < 15 CBR, subgrade improvements are to be made to bring the subgrade strength up to a CBR of 15
- The pavement shall be sealed with a 3/5 two coat seal in accordance with 3.4.7.

3.4.11 Road Signs

3.4.11.1 Scope

This section covers the specifications for the supply and installation of all road signs.

3.4.11.2 Standards

All signs are to be constructed and installed in accordance with the relevant specifications detailed in Clause 3.2.2 in particular the Traffic Control Devices Manual, and the following:

- a) Signs shall be Class 1 wide observation angle (VIP or equivalent) reflective sheeting
- b) The face of all signs shall be rivetless.
- c) The back of all signs shall be coloured 'aircraft grey' No. 693 as referred to in BS381C, or similar, with a semi-gloss finish, unless otherwise stated. 'Slate grey' (in accordance with the NZTA specifications) is an approved alternative.
- d) All signs are to have an aluminium substrate.
- e) Regulatory, warning, street name plates and information signs shall be Class 1 reflectorised sheeting.
- f) Parking signs shall be non-reflective.
- g) Where the option exists for square or radius corners, radius corners shall be supplied

3.4.11.3 **Attachment**

Signs shall be attached to posts or overhead gantries using Signfix or equivalent brackets as approved by Council. The Contractor shall be responsible for determining sign mounting requirements.

3.4.11.4 **Poles**

Steel poles are to be either NB56 or NB65 poles appropriate to the type and size of sign required and in accordance with Table 3-12. Poles are to be powder coated white. All poles are to be capped with power coated top caps to match pole.

Timber poles shall be 100 x 100mm H4 dressed framing grade 1 or 2, pre-painted using one undercoat and two topcoats of high gloss exterior white paint.

3.4.11.5 **Site Installation details for posts and poles**

Where installation and/or reinstatement work is required within a sealed surface, the surface must be saw cut around the perimeter of the excavation. The replacement surfacing shall be of a material and placed to match the existing surrounding surfacing.

3.4.11.6 **Typical Sign Installation and Location**

All signs shall be located in accordance with the NZTA’s Traffic Control Devices Manual and NZTA’s Manual of Traffic Signs and Markings (MOTSAM) Part 1: Traffic Signs, Additional specifications in Table 3-12 shall also apply.

Table 3-12: Additional Signage Specifications

SIGN TYPE	POLE TYPE	POLE LENGTH	HEIGHT	LOCATION
Regulatory	NB65		2.5m BOS (above a footpath) 2.0m BOS (in traffic island)	Longitudinal Offset: a) 5m (± 1m)* from tangent to intersecting road kerb line (behind kerb line) b) 3m from island nose (in traffic island) Lateral offset: a) Poles shall not be closer than 500mm from kerb line. Sign shall not be closer than 350mm from kerb face. b) In centre of traffic island with a maximum offset of 1m from island kerb face.
Warning	NB 56	3.7m	2.0m BOS 2.5m BOS when above a footpath	In centre of traffic island 500mm lateral offset between sign and kerblines
Information	NB 56	3.7m	2.0m BOS 2.5m BOS when above a footpath	
Free Turn	NB 56		250mm BOS	1.5m from traffic island nose In centre of traffic island 500mm lateral offset between sign and kerblines
Street Name	NB 56	3.7m	3.0m TOS (measured to upper blade)	Lateral offset: Minimum 500mm, maximum 1500mm between closest part of name signs and

SIGN TYPE	POLE TYPE	POLE LENGTH	HEIGHT	LOCATION
				kerb or seal edge. Part of the signs blade should be located within 1500mm of the kerb face but provide at least 500mm clearance to the kerb face or edge of seal. Where this is not possible, the signs may be reverse mounted as long as the footpath is not obstructed. Refer to Drawings D3.7.2 , D3.7.3 , D3.7.4 , D3.7.11 , D3.7.12 .
Tourist sign	NB 56	3.7m	2.0m BOS 2.5m BOS when above a footpath	
Route marker	NB 56	3.7m	3.0m TOS	
Truck Bylaw	NB 56	3.7m	2.0m BOS 2.5m BOS when above a footpath	Refer Drawing D3.7.17
No stopping	NB 56	3.25m	2.0m BOS 2.5m BOS when above a footpath	
Bus Stop	NB 56	3.25m	2.7m TOS 2.4m BOS if sign is for Orbiter route	1m from end of park
Bus stop supplement sign			Aligned to the top of the associated Bus Stop sign.	Refer Drawing D3.7.16 oriented @ 90 degrees to adjacent kerb face or edge of seal such that it can be seen by approaching motorist
Taxi Stand	NB 56	3.25m	2.7m TOS	1m from end of park
Taxi stand supplement sign			Aligned to the top of the associated Taxi Stand sign.	Refer Drawing D3.7.16 oriented @ 90 degrees to adjacent kerb face or edge of seal such that it can be seen by approaching motorist
Loading Zone	NB 56	3.25m	2.7m TOS	1m from end of park
Parking	NB 56	3.25m	2.7m TOS	1m from end of park
Mobility Parking	NB 56	3.25m	2.7m TOS	1m back from front of park
Keep Left	Knock down socket	750mm	250mm BOS	1.5m from traffic island nose. Refer Drawing D3.7.1
Diverge Sign	Knock down socket	750mm	250mm BOS	1.5m from traffic island nose In centre of traffic island 500mm lateral offset between sign and kerb line.
Chevron Board	NB 56	1.1m	750mm TOS**	Refer Drawing D3.7.10

SIGN TYPE	POLE TYPE	POLE LENGTH	HEIGHT	LOCATION
Chevron in Roundabout			750mm TOS	1m from kerb face and perpendicular to sight line of approaching vehicles approximately 50m from intersection. refer Drawing D3.7.10
Route sign (in place of chevron in roundabout)			750mm TOS 100mm BOS if the area is not planted	Lateral offset – 500mm from kerb face to sign. If no kerb, ≥1.5m from the edge of seal
Median island Low level street name	NB 56	1.1m	750mm TOS.	refer Drawing D3.7.10
Route shield	NB 56	1.1m	750mm TOS	
ADS sign (on 2 poles):				Specific design required

All signs installed adjacent to cycleways or shared paths shall have a minimum clearance to the bottom of the sign of 2.2m.

Key:

TOS – Dimension is the clearance between the top of the sign and the top of the adjacent footpath/berm/traffic island

BOS – Dimension is the clearance between the bottom of the sign and the top of the adjacent footpath/berm/traffic island

* Tolerance to accommodate possible site constraints

** Consideration should be given to road vertical alignment when determining sign height

3.4.11.7 Parking Signs

Parking signs shall be as detailed in Traffic Control Devices Manual.

3.4.11.8 Signs on Cycleways or Shared Walkway/Cycleways

Refer [Drawing D3.7.5](#) for signage of shared cycle path start and end points.

3.4.11.9 Street Name Signs

Design

Street name signs shall be designed in accordance with the Traffic Control Devices Manual – Part 2: Direction, service and general guide signs, and Table 3-12.

On no exit roads, a 75mm tall separate, supplement plate shall be attached (taped) to the bottom edge of the street name sign.

All signs are to be double-sided, except those on medians or at the head of ‘T’ intersections.

Repeater plates of the primary road shall be erected at every intersection.

Legend

The standard abbreviations listed in Traffic Control Devices Manual – Part 2: Direction, service and general guide signs shall be used, with the addition of the term 'Rise' (no abbreviation necessary).

These abbreviations shall have a letter height of 50mm and 75mm for secondary and primary streets respectively.

Location of Street Name Signs

Street name signs are to be located in accordance with Table 3-9 above. If there is a utility pole in the proposed location, then the signs shall be attached to it. (See Note 4 of [Drawing D3.7.11](#)).

Street name signs at signalised intersections shall be installed in accordance with [Drawing D3.12.6](#).

Poles shall be either NB56 or NB65 steel poles, as appropriate to the type of sign required.

3.4.11.10 General Interest Signs (formerly referred to as Amenity Signs)

Refer to section in Traffic Control Devices Manual – Part 2.

Design

General Interest signs are to be in accordance with the following specification:

Table 3-13: General interest sign specification

Letter height	125mm
Letter styles	as for Street Name signs
Letter spacing	as for Street Name signs
Background depth	175mm
Blade profile	90° cuts at both ends
Colours	Blue reflectorised lettering on a white reflectorized background - all reflectorisation to be Engineering Grade
Arrows	Blue reflectorised triangular arrow at the end of sign plates. Refer to D3.7.2 , D3.7.3 and D3.7.4 .

Location

General Interest signs are to be located in accordance with the following specification:

Table 3-14: General interest sign locations

Height of sign blade	As for Street Name signs
Lateral offset	As for Street Name signs

Number of signs	Maximum of two General Interest signs per facility
-----------------	--

Note: In addition to standard mounting requirements (Drawings [D3.7.11](#) and [D3.12.6](#)), General Interest signs are to be attached below existing street name signs.

3.4.11.11 **Route, Guide, Service and Tourist Signs**

Destinations, routes and facilities to be used on route, guide, service and tourist signage must be as supplied by Council's Transportation team. Refer also to Traffic Control Devices Manual – Part 2.

3.4.11.12 **School Patrol Signs**

Signs shall be manufactured and installed in accordance with [Drawing D3.7.15](#). Support posts shall be white and installed in accordance with [Drawing D7.7](#) Timber Bollard Post and Chain.

3.4.11.13 **Kea Crossing Flag and Pole**

Kea Crossing flags and poles are to be constructed and installed in accordance with Drawings [D3.7.13](#), [D3.7.14](#)

3.4.11.14 **Overhead Gantries**

Overhead gantries shall be individually designed in accordance with, and shall comply with the requirements of, NZTA's Highway Structures Design Guide.

The design shall include structural and environmental requirements and the provision of safe maintenance access to the structure, and shall meet the following additional requirements:

- a) The gantry design will depend on the proposed size of sign and hence loading and ground clearance
- b) Sign mounting uprights shall be spaced at no greater than 900mm centres
- c) Overhead gantries may be constructed from either a single piece welded or a bolted outreach arm
- d) Gantries shall be hot dipped galvanised after fabrication. All mount bolts shall be galvanised.

The layout drawings for the site locations of all structures and associated maintenance access and traffic barriers shall be submitted to a nominated Safety Auditor for a Stage 3 Design Safety Audit. The contractor shall amend the site layout design to comply with the Safety Audit recommendations or shall submit to the Engineer a proposal that has been prepared by a qualified Traffic Consultant that modifies the Safety Audits recommendations, but does not compromise the intention of the recommendations.

No work shall be undertaken on the gantry until the design is accepted in writing by the Engineer.

3.4.11.15 **Edge Marker Posts**

All edge marker posts (EMP) shall be constructed in accordance with the NZTA's Specification M/14 : Edge Marker Posts.

EMPs shall be located on rural roads only and in accordance with the MOTSAM – Part 2: Markings.

3.4.11.16 **Semi - Rigid Barriers (W-Section)**

All barriers complete with reflective inserts are to be constructed in accordance with the NZTA's Specifications M/17P : W-Section Bridge Guardrail, P/15P : Fabrication and Assembly of Standard Guardrails and Handrails for Highway Bridges and Bridge Approaches, M/23 : Road Safety Barrier Systems, and with AS/NZS 3845.

Painting of barriers may also be required on a case-by-case basis and should be confirmed with the relevant Council. All painting shall consist of at least two finish coats of water based commercial grade paint (colour to be specified by Council). All dirt, grime and loose and flaky paint shall be removed from the surface prior to painting. It may be necessary to undercoat in some areas as required. All painting is to be carried out in accordance with the manufacturer's specifications. Reflective inserts are to be retained.

3.4.11.17 **Wire Rope Barriers**

To added at a later date

3.4.11.18 **Timber Sight Rails**

All painting of timber sight rails shall be completed with at least two finish coats of water based commercial grade white paint. All dirt, grime and loose and flaky paint shall be removed from the surface prior to painting. It may be necessary to undercoat in some areas. All painting shall be carried out in accordance with the manufacturer's specifications.

3.4.11.19 **Themed Street Furniture (bins, seats, specialised street lighting, etc)**

The Council may have towns or suburbs with a particular street furniture theme. **For details of these themes, refer to Appendices.**

3.4.11.20 **Wheel stops**

All wheel stops shall be standard pre-cast rubber units, with the top of the wheel stop being no more than 100mm above the adjacent surface.

3.4.11.21 **Wayfinding Signage**

Wayfinding signage is subject to additional specifications and requirements. **See Appendices for options.**

3.4.12 **Pedestrian Barrier Rails and Handrails**

Pedestrian barrier rails and handrails shall be constructed and installed in accordance with the following Drawings:

- [D3.8.7 - CBD pedestrian barrier](#)
- [D3.8.8 - Pedestrian balustrade barrier.](#)
- [D3.8.9 - pedestrian barrier detail](#)
- [D3.8.10 - pedestrian accessway fence detail](#)

3.4.13 Walkway Barriers and Cycle Racks

All walkway barriers and cycle racks shall be constructed and installed in accordance with Drawings [D3.8.2](#), [D3.8.3](#) and [D3.8.11](#)

3.4.14 Bus Stops

This section covers the supply and installation of all components necessary for a bus stop including signage, seats, raised accessible kerb lines and bus shelters.

3.4.14.1 Standards

All bus stops shall be constructed in accordance with the NZTA Guidelines for Public Transport and Infrastructure and Facilities, unless Council has requirements which will vary the above standard.

3.4.14.2 Signage

All signage shall be installed in accordance with the requirements set out in section 3.4.11: Road Signage and Street Furniture. However some locations may require supplementary bus stop signs. See [Drawing D3.7.16](#).

3.4.14.3 Seats

Where seats are required, but there is no shelter, they shall be in accordance with [Drawing D3.8.15](#). Materials and colour to be confirmed by the Council.

3.4.14.4 Accessible kerb lines and tactile paving

Where specified, accessible kerb lines and tactile paving shall be installed in accordance with the ARTA Bus Stop guideline and Drawing [D3.6.3](#) and [D3.3.8](#).

3.4.14.5 Shelters

Bus shelters shall be installed as instructed by Council and in accordance with Drawings [D3.8.13](#) and [D3.8.14](#).

The large size bus shelter shall be used in all locations except where an installed shelter would narrow the adjacent footpath to less than 1.2m. The mini shelter shall be installed instead.

Bus shelters shall be painted/powder coated in black semi-gloss.

3.5 LINE MARKING

This section covers all aspects of line marking, including the supply and fixing of reflective and/or non-reflective road studs and delineators, and the removal of line marking.

3.5.1 Setting Out and Timing

The proposed line marking is to be set out in accordance with the accepted drawings, and any location marking out provided by Council, with modifications as necessary to make the 'lines' pleasing to the eye.

Where there are inconsistencies between the line marking layout plans and the NZTA specifications, the line marking layout plans shall prevail.

Council's approval of the set out is required prior to marking. In order to achieve this with the least delay, at least 48 hours' notice prior to approval being required shall be given to Council.

Incorrect line marking that has been applied without approval of the set out shall be removed at no cost to Council.

On new surfaces, marking of centreline, limit lines and other intersection markings such as Give Ways shall be completed within 48 hours of completion of the surfacing.

For roads that are not open to traffic, such as new subdivisions, these markings shall be completed before the road is opened to the public.

Other markings on new surfaces shall be completed within seven days of surfacing. For other works such as line removals or maintenance, timing will be specified by Council.

3.5.2 Paint Types

At a minimum, all paint shall at least conform to NZTA's specifications M/7 'Class A' type and P/12.

All new line markings shall generally be waterborne/acrylic.

Chlorinated rubber or alkyd is to be used for arterial and collector roads on their final surfacing.

Thermoplastics are to be used in CBD areas. Alkyd paint must be used on sites that are to be re-marked with thermoplastic paint at a later date.

3.5.2.1 Waterborne/Acrylic Paint

Waterborne paint shall be applied in accordance with NZTA Specifications P/12 and M/7, with the following amendments.

Table 3-15: Waterborne/acrylic paint specification amendments

Clause 13.1 (a) NZTA P/12 – replace with:	'The finished dry film thickness shall be 300 microns or greater as defined by the equation in NZTA P/12'
---	---

All waterborne/acrylic markings are to be reflectorised in accordance with NZTA P/22.

3.5.2.2 Alkyd Paint

Alkyd paint shall be applied in accordance with NZTA Specifications P/12 and M/7, with the following amendments.

Table 3-16: Alkyd paint specification amendments

Clause 13.1 (a) NZTA P/12 – replace with:	'The finished dry film thickness shall be 180 microns or greater as defined by the equation in NZTA P/12'
---	---

3.5.2.3 Chlorinated Rubber

Chlorinated Rubber or similar paint shall be applied in accordance with NZTA Specifications P/12 and NZTA M/7, with the following amendments.

Table 3-17: Chlorinated rubber specification amendments

Clause 13.1 (a) NZTA P/12 – replace with:	'The finished dry film thickness shall be 220 microns or greater as defined by the equation NZTA P/12'
---	--

All chlorinated rubber markings are to be reflectorised in accordance with NZTA P/22.

3.5.2.4 Thermoplastic

Where long life or thermoplastic materials are specified they shall be supplied and applied in accordance with NZTA M/20 specification. The type of long-life material proposed to be used and details of type of approval to NZTA M/20 specification shall be submitted with any tender or proposal.

3.5.2.5 Re-markings

A re-mark will be required within 3-6 months (or prior to completion of defects period if shorter) depending on wear and deterioration of the markings. This re-mark will be with the final paint type specified in section 3.5.22 above. Approval must be obtained from Council prior to completing this re-mark to determine the paint type and final layout of the line marking.

3.5.3 Equipment Certificates and Staff Competence

All line marking equipment used for applying paint and glass beads shall have a current NZTA T/8 certification and be in a certifiable state.

All line marking equipment used for applying long life or thermoplastic materials shall have a current NZTA T/12 certification and be in a certifiable state.

The senior operator of each road marking crew must have at least a minimum qualification approved by the Industry Training Organisation (ITO). At least one person in each road marking crew shall be a qualified Traffic Controller (TC) in accordance with the NZTA COPTTM.

3.5.4 Raised Pavement Markers (RPM)

All reflectorised pavement markers are to be glass faced (long life) or equivalent with NZTA Specification M/12 type approval.

All pavement markers are to comply with NZTA M/12 (and NZTA M/12 notes). Installation of raised pavement markers shall comply with NZTA P/14, MOTSAM, and any subsequent NZTA document (e.g. RTS 4 'Guidelines for Flush Medians'). Further to this, Council may require specific RPM layouts in certain locations.

Where 'Active' RPMs are specified, these shall incorporate solar panels and LED lights so that they do not rely solely on reflected light.

3.5.5 Removal of Line marking

When redundant line markings require erasure, Council will specify the method to be used.

3.5.5.1 Removal

When 'removal' is specified, the line marking material (paint or thermoplastic) shall be removed from the road surface. Typical methods include grinding, sandblasting (wet or dry) and ultrahigh-pressure water cutting, but other methods may be considered acceptable by Council. Care shall be taken so that damage is not caused to the underlying road surface and that 'ghosting' of the marking does not occur.

Once complete, the surrounding area shall be swept clean of all sand, paint chips or other debris. This material shall be suitably disposed of with care being taken to ensure that no solid matter enters any waterway or stormwater system as a result of the removal operation. This may require the placement of filters or similar on catch pits and other drainage features.

Details of methodology, including materials to be used, equipment, staff skills and qualifications and quality assurance shall be supplied with tenders or proposals.

3.5.5.2 Cold Applied Plastic Blackout

Permanent erasure of markings may be specified to be carried out with cold applied plastic (CAP) material.

Existing long life markings or multi-layered line markings should be ground off before applying CAP Blackout. The base coat shall be a two-component cold plastic, designed and formulated for use as a road marking material and complying with NZTA specification M/20. The CAP shall be pigmented to a grey or charcoal colour that is close to the colour of the existing road surface. The product shall be mixed and applied in accordance with manufacturer's instructions.

Where the area to be blacked out abuts markings that are to remain, the edge of the blackout shall be masked off, otherwise an irregular edge to the blackout is desirable to minimise any ghosting effect. While the plastic material is still wet, crushed stone or grit shall be evenly broadcast onto the base.

The grit shall be a sound crushed mineral or synthetic aggregate with 95% passing a 6.7mm BS sieve and no more than 15% passing a 2.36mm BS sieve. The CAP material thickness and grit size shall be matched so that approximately 60% of the grit depth is embedded into the plastic material.

The aggregate shall have a maximum of 2% weak materials when tested using the Australian Weak Particles Test (AS 1141.32).

3.5.6 High Friction or Coloured Aggregate Surfacing

High friction or coloured aggregate surfacing is to be applied at locations specified by Council. Both surfacing types generally use a specialised aggregate bonded to the road surface in an epoxy or polyurethane resin so are included in the same specification.

Proprietary surfacing systems shall be applied in accordance with the manufacturer's specification and by the manufacturer's approved applicators.

Documents that relate to this section are the NZTA Specification M/6 : Sealing Chip.

All technical documentation regarding the proprietary product or system to be used shall be submitted.

3.5.6.1 **Surface Preparation**

The surface shall be clean of any dust, detritus or loose matter. Any oil visible on the surface shall be removed by washing with a detergent solution, followed by flushing with clean water, or other suitable system.

Care shall be taken to ensure that no solid matter enters any waterway or stormwater system as a result of the removal operation. This may require the placement of filters or similar on catch pits and other drainage features.

The surface is to be completely dry before application of the binder.

All existing line marking, pavement markers, catch pits and kerbing shall be suitably masked so that only the road surfacing is coated.

The suitability of application to the pavement at the sites specified shall be discussed with Council using the manufacturer's guidelines.

3.5.6.2 **Binder**

The binder shall be a suitable epoxy, polyurethane or other approved proprietary product compound. When used in conjunction with coloured aggregates the binder shall be pigmented to the same colour as the aggregate. Thermo plastic binders shall not be used.

The cured binder shall be flexible so that it does not crack or delaminate under traffic loadings on non-rigid pavements.

The binder shall be capable of holding the aggregates so they do not become embedded or dislodged under heavy braking.

3.5.6.3 **High Friction Aggregate**

The aggregate shall be calcined bauxite or equivalent, which has a PSV greater than 70 when tested in accordance with BS 812-Part 114.

The grading of the aggregate shall be as follows.

- a) less than 5% retained on 4.75mm BS sieve
- b) less than 5% passing 1.18mm BS sieve

The aggregate shall be clean and free of foreign matter. The aggregate shall comply with the NZTA specification M/6 strength, shape and weathering resistance requirements.

3.5.6.4 **Coloured Aggregate**

The aggregate shall be a chemically inert, semi translucent, synthetic aggregate that complies with shape, strength and weathering requirements of the NZTA specification M/6 and is coated with colouring compound(s) to produce the specified colour.

The grading of the aggregate shall be as follows.

- a) less than 5% retained on 4.75mm BS sieve
- b) less than 5% passing 1.18mm BS sieve

The aggregate and binder system shall be designed to achieve a high level of colour retention and resistance to both traffic abrasion and weather such that colour is intact and effective for at least five years from the initial installation. The aggregate shall have a minimum PSV value of 50 when tested in accordance with BS 812-Part 114. The surfacing must be capable of being cleaned by high pressure water jet to remove dirt, grime and debris in order to restore the colour.

3.5.6.5 **Mixing, Batching and Application**

The manufacturer's guidelines for the mixing, batching and application rates of product shall be followed, unless otherwise directed by Council.

3.5.6.6 **Curing and Aftercare**

All masking shall be removed together with the binder adhering to it. During the curing period, no disturbances or trafficking of the treated surface is permitted.

The cure time shall be to the manufacturer's recommendations required under the particular site conditions.

Before trafficking, excess chip shall be removed. Along with any subsequent chip which may have eroded off the treatment for a period of one month following opening of surface to traffic.

3.5.6.7 **Performance**

The minimum performance requirements are:

- a) SCRM Value – shall be at least 0.7 ESC
- b) Aggregate Retention – a visual assessment of the surfacing shall be performed to assess the level of coverage and retention. Aggregate retention shall be assessed by determining coverage on any 300mm x 300mm area. The surface shall be rejected if any three locations have less than 95% chip coverage
- c) Texture Depth – the surfacing shall be rejected if any three locations have a mean profile depth of 1.0 mm or less (105mm sand circle if determined in accordance with NZTA Specification T/3).
- d) Cracking/Delamination/Sliding – the surfacing shall be rejected if there are any of the above conditions present at the end of the three month defect liability period.

3.5.6.8 **Cleaning**

When cleaning of existing high friction or coloured surfacing is required, a high-pressure water jet or other suitable means shall be used to remove all dirt, grime, debris and the like from the surface. Care shall be taken to avoid damage to the surfacing.

Care shall be taken to ensure that no solid matter enters any waterway or stormwater system as a result of the removal operation. This may require the placement of filters or similar on catch pits and other drainage features.

3.5.7 **Coloured Markings**

When specified, some markings may be required in colours other than white or yellow.

Typical applications are.

- a) Green for cycle way markings or bus only lanes
- b) Blue for disabled car park spaces

Actual colours will be specified at the time. Such markings shall use the applicable paint type specified in section 3.5.2, coloured to the specified colour. Paint application shall be in accordance with the relevant clauses of this specification.

3.5.8 Temporary Markings

When specified, temporary markings may be required that can easily be removed when no longer needed. Such markings shall be capable of withstanding normal road traffic and weather conditions for a period of at least three months, or longer if specified. When no longer required the markings shall be removed without causing damage to the underlying road surface.

Full details of materials proposed for temporary markings, their method of application and removal, and typical properties shall be supplied with any proposal for use. All materials shall be handled and applied in strict accordance with manufacturer's specifications and datasheets. In particular, all environmental precautions shall be adhered to.

Typical methods of temporary marking include 'removable paint' and self-adhesive road marking tape.

3.5.9 Non Standard Markings

3.5.9.1 Cycle Symbols

The cycle symbol shall be set out in accordance with the NZTA Traffic Control Devices Manual, but may be scaled to be 1200mm or 800mm high as directed by Council.

3.5.9.2 Cycleway 'End'

The word 'End' shall be painted at the end of cycle lanes along with a cycleway symbol, where directed by Council. 'End' shall be 600mm high x 900mm long.

3.5.9.3 Cycleway Hold Bars

Cycleway hold bars are used at signalised intersections with advance cycle 'stop-boxes'. The cycleway hold bars shall be 100mm wide with 200mm gap. Refer to [Drawing D3.9.1](#) for more details.

3.5.9.4 Cycleway Hook Turns

Cycleway hook turns are to be provided at signalised intersections where turning right is likely to be considered a difficult manoeuvre for cyclists. Final cyclist provisions are to be confirmed by Council.

3.5.9.5 Speed Cushions and Speed Humps

The approach faces of speed cushions and speed humps shall be painted with reflectorised white triangles to facilitate visibility. The width of the triangles shall be such that there are at least three triangles on each speed cushion and the depth shall cover the full depth of the tapered approach face of the speed cushion.

3.5.9.6 Pedestrian Platforms

The faces of raised pedestrian crossing platforms and full width speed control devices shall be marked with white reflectorised cross-hatching as dimensioned in Traffic Control Devices Rule Diagram M4-2. Unless otherwise stated, poles located within medians shall be installed with a socketed base to allow quick and easy replacement.

3.6 STREET LIGHTING CONSTRUCTION

3.6.1 Installation

Each street light position is an Installation as defined in AS/NZS3000.

All construction work to be undertaken by competent/approved contractors and in accordance with the Electricity Regulations 2010, AS/NZS3000 and the applicable Electrical Codes of Practice. The most recent amendments must be used and approved by the network company.

All installations are subject to test and provision of ESC or CoC.

3.6.2 Connection to network

All proposed street lighting connections must be approved by the relevant network company prior to commencement of the project.

The steps to follow in pre- installation and installation stages are outlined below:

- Submit proposed design/ lighting plan to the network company for verification of supply points
- Submit Application for New connections detailing additional load required for new streetlights

In order to live new lighting installations the network company will require the following documentation:

- Approved Application for New Connection
- CoC or ESC signed by authorized person
- As built in format approved by the network company
- Confirmation of practical completion or 224c sign off.

All parties involved in the street lighting installation shall comply with the network company's design and connections standards and procedures.

3.6.3 Installation

All Columns are to be installed in accordance with the manufacturer's specification, electrical codes and health & safety acts.

The column position in developed areas shall be pegged in advance of the work and adjacent property owners notified in writing of the works so that any issues over column location can be resolved before installation begins.

Contractor to submit Corridor Access Request and confirm underground services location prior to groundworks commencing in developed areas.

If the contractor finds underground bed rock (e.g. rhyolite) or finds underground services not allowed for, that precludes installing a column in the desired location, they are to contact the council for guidance rather than simply moving the column.

Any groundwork carried out for installation is to be re-instated to council's standard.

Access doors shall be accessible.

Any damage caused prior to the hand-over to council must be repaired as new with all warranties remaining intact.

Internal wiring, earthing and circuit protection devices to comply with the network company's Design and Construction Standard.

Luminaires shall be installed on columns in accordance with the manufacturer's recommendations. The horizontal axis shall be level and with the specified tilt angle. Where existing brackets or outreaches have a different tilt angle to that specified for new lights, new luminaire with internal tilt mechanism may be used or suitable tilt wedges shall be installed so that the existing luminaires have the same tilt angle as any new fittings.

3.6.4 Cables

Underground cable installations shall be provided to all street lighting columns except for lights specified to be installed on existing power poles. Cable route and conductor sizes shall be designed and installed in accordance with network company's requirements. Warranty period for new cables is 12 months.

All new installations shall be designed to be controlled through the Network Owner's control system.

All column installations shall be provided with approved internal termination junction boxes for terminating lighting circuits. These are to be located at the gear openings of each column.

Cables installed vertically on power poles shall be fitted and enclosed in accordance with requirements of the network company.

3.6.5 Trenching

Underground cables to be installed to the network company's requirements. In order to prevent damage to road pavement and minimise disruption to the public thrusting must be used under existing carriageways, vehicle entrances and footpaths

Location of the cables in green fields should be as detailed in [Drawing D3.1.3](#) Location of Services in Transport Corridor.

3.6.6 Lighting Upgrades

Where lighting columns or circuits are being relocated, extended or upgraded, the existing supply, protective devices and switching control may be reused if it is in compliance with this specification.

In the event that an existing circuit is extended, the network company will confirm if the supply relays and fuses are suitably rated for the additional electrical load of the new lights. The Contractor will be responsible for any costs associated with upgrading the supply point, fusing, changing relays or fitting contactor sets associated with the additional lighting load.

All additional fittings and materials used shall be new and consistent throughout the installation. If in-fill lighting or continuation of an existing system the new fittings and materials shall match the existing, if practicable.

3.6.7 Existing Luminaires, Columns and Control Gear Made Redundant

The Council's Street Light Maintenance Contractor shall be given an opportunity to acquire any surplus luminaires, columns and associated spare parts made redundant, for the purpose of utilising them as maintenance spares. The Contractor shall be responsible for disposing of any redundant 'not wanted' materials including capacitors containing PCB's.

All non-usable parts are to be disposed of correctly and certificates provided to Council to this effect.

3.6.8 Inspections and Testing

Prior to commissioning all inspections and testing required by the network company shall be carried out. Written confirmation is required from the network company that it accepts all underground cabling and circuitry and will assume responsibility for future maintenance and renewal.

A lux survey may be requested by Council at the contractors cost.

3.7 TRAFFIC SIGNALS

3.7.1 Scope

This section covers the procedure and requirements for all new or upgraded traffic signals that are to be managed by Hamilton City Council. This includes the design, supply, installation, and commissioning of new and existing traffic signal equipment.

3.7.2 Specifications

All traffic signals are to be installed in accordance with the Specifications and Standards listed in Clause 3.1.2. The following Council specifications supersede NZTA P43 requirements.

Where reference is made in any Specification to RCA or Client, this shall be read as Council.

3.7.3 Traffic Signal Equipment

3.7.3.1 General

This section contains specific requirements for the supply and installation of the controller, detectors, junction boxes and poles.

3.7.3.2 Traffic signal controller

Unless specified, the coating colour shall be the industry standard to match existing controllers in Hamilton.

A sticker shall be placed on each controller box in accordance with the following figure.

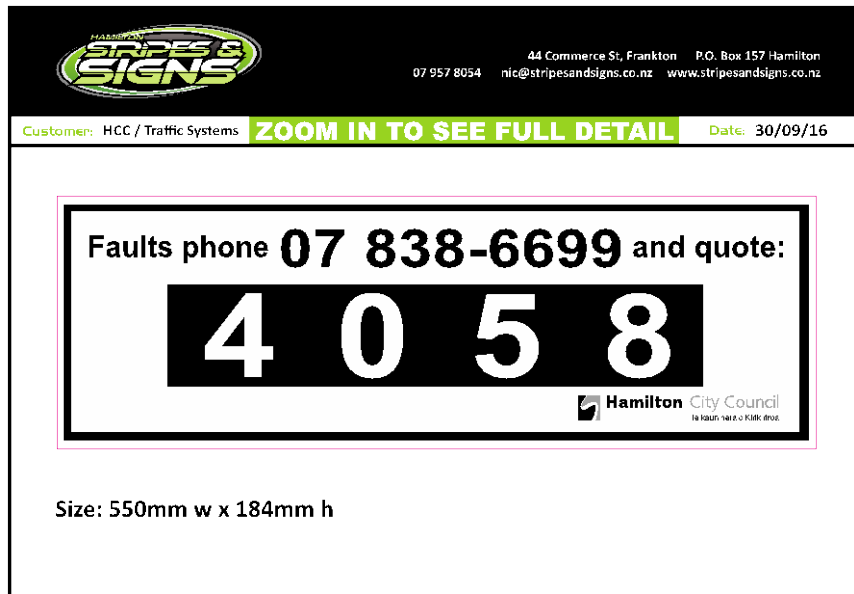

Drawing 3-1: Traffic Signal Box Sign

3.7.3.3 Detector Loop Encapsulation

The approved flexible sealant as referred to in P43 is Plasticast LQB Tixophiate, which is a two part epoxy compound formulated specifically for the encapsulating of traffic signal detector cable loops which are embedded in asphaltic road surfaces.

3.7.3.4 Kerbside Junction Boxes

Access for loop-feeder between detector loop and toby box may be obtained in two ways:

- a) **Under kerb access** - to be used in all cases where new kerb and channel is to be constructed; Under kerb access shall consist of 25mm alkathene water pipe laid from the toby box under the kerb and to within 50mm of the top of the seal and within 100mm of the edge of the seal. The access hole in the pavement shall be backfilled, compacted with basecourse material, and sealed.
- b) **Saw cut through kerb and channel** - may be used where existing kerb is to be retained;

A 5mm wide saw-cut may be made through the kerb and channel and sealed with Sikadur 43 epoxy resin mortar* or equivalent

3.7.3.5 Shop Verandas, Poles and Other Obstructions

Any obstructions which will interfere with the installation, visibility or operation of the signals will be removed or altered by the Contractor.

Where such obstacles originate in private property, clearance to proceed with this work shall first be obtained from Council. Some delay may occur while the property owner is contacted.

Note: All alterations to services will be undertaken by the appropriate service authority.

3.7.4 Communications

Unless otherwise specified, all new traffic signals and cameras shall be connected to the HCC City Transportation Unit's (CTU) traffic signal network. This network uses a combination of 4G wireless, fibre and point-to-point links. Either one of these methods may be appropriate for the site. Council will advise the appropriate communication method for the site and in most cases will provide pre-configured hardware for the Contractor to install, such as a router and radio.

A radio must be mounted appropriately (typically attached to a signal pole) to achieve the signal strength requirements. The router shall be housed in the traffic signal controller cabinet.

Each installation must include initial site coverage testing and scoping, power supply to the radio, and all associated ducting and cables including a shielded outdoor grade cat6 cable from the controller to the radio running inside the pole to the radio mounting location.

The traffic signal controller must achieve continuous SCATS communications for a minimum of 48 hours prior to commissioning.

3.7.5 Provision of Cameras

Unless otherwise specified by Council a traffic monitoring camera must be installed and connected at all new traffic signal installations or sites subject to major upgrade, with the exception of mid-block pedestrian crossings. All camera hardware must have a minimum warranty period of 12 months from the date of installation.

3.7.5.1 Camera Specifications

Traffic monitoring camera must meet the following technical requirements:

- a) Cameras are to be digital, IP based, PTZ, outdoor units
- b) Each new installation shall include the camera and PTZ unit, controller and communications interface, power feed, housing, mounting, and pole (if required)
- c) Cameras must be compatible with the Milestone and DVTel management systems
- d) Unless specified, the required camera viewing distance shall be assumed to be 250m
- e) Minimum 12x optical zoom
- f) The zoom and stability shall be such that the displayed image at the viewing distance with maximum optical zoom is no larger than the road carriageway, and image shake does not exceed 3% of the image size in any direction
- g) Image sensor must be colour CCD with minimum size $\frac{1}{4}$ '
- h) Minimum horizontal resolution of 480 lines
- i) Appropriate sensitivity and image correction for day and night observations

- j) 360 degree pan rotation with image auto-flip, allowing tilt from horizontal to -90 degrees
- k) Minimum of 10 pre-set PTZ positions
- l) Camera and housing to provide a minimum IP66 ingress protection to IEC 60529, and include a sun shield and condensation prevention
- m) Appropriate video compression to communicate over the communications network (H264 is the preferred method)

3.7.5.2 Camera Location and Mounting

The camera should be located such that:

- a) Every traffic lane is visible at the intersection limit line
- b) Required viewing distance is achieved down each leg
- c) Viewing is optimised for legs with adjacent signalised intersections

Unless otherwise specified, mounting on a traffic signal pole such as a Joint Use Mast Arm (JUMA) is permitted where practical.

The Contractor shall supply and install a shielded outdoor grade cat6 cable from the controller to the camera location, running inside the pole to the camera mounting location.

Council must approve the final location prior to installation of pole or camera. A site assessment plan showing the location and visibility of the proposed camera must be provided to Council for approval.

3.7.6 Warrantees, Guarantees and Maintenance

All materials and equipment supplied and/or installed (including the installation) shall have guarantees and warrantees in accordance with P43.

Practical completion will not be issued until Hamilton City Council and the current signals maintenance contractor have approved the works and site operation. Hamilton City Council's Signal Maintenance Contractor will carry out regular maintenance on the intersection immediately following practical completion and if any faulty equipment or installation work is identified, then the Contractor responsible for installing the equipment will be required to fix and/or supply parts to fix the fault at no cost to the Road Controlling Authority.

During the construction and maintenance periods, the Contractor shall also be required to pay all costs incurred by Hamilton City Council's Signal Maintenance Contractor (who has been contracted to maintain the overall intersection) for isolating and making safe any reported faults which can be directly attributed to the signal installation or modification work. This includes any faults in materials, equipment or workmanship. The Contractor will be invoiced separately for this work or more commonly, the amount will be deducted from the contract price or from any maintenance retentions owing.

At the end of the maintenance/defects liability period the equipment shall be handed over in full working order with no defects. Where such defects exist, whether in control equipment, detectors, or signal hardware or in any part of the equipment supplied, these shall be made good at no expense to Hamilton City Council.

3.7.7 Design Requirements

3.7.7.1 Filter Turn Warrant

A right turn may be permitted to filter unless any of the following criteria are met:

- a) The right turn movement has experienced more than five “right turn against” type injury accidents in the last five years. This requires further consideration – see below
- b) Visibility is less than the safe stopping distance at the design speed, either by horizontal or vertical alignment, or where the opposite right turn hides approaching through traffic
- c) There are three (or more) opposing through lanes to cross
- d) The right turn movement has two (or more) right turn lanes
- e) There are two (or more) opposing left turn lanes
- f) There is a need to provide protection of the pedestrian crossing at all times.
- g) The 85th percentile operating speed of opposing traffic is greater than 70 km/h

Where an existing filtered movement has more than five “right turn against” type injury accidents, two further aspects should be reviewed:

- a) The accidents should be investigated to determine if there are any common factors such as time of day. If the accidents predominantly occur during similar periods, consideration should be given to providing a time based filter.
- b) Consideration should be given to undertaking a benefit cost analysis for the filter turn, where an intersection relies on a filter movement to operate effectively during peak periods. If travel time savings gained from the filter turn sufficiently outweigh the associated accident cost, the filter turn could be retained.

The decision to allow or prohibit a movement to filter is a complex engineering decision. While the above criteria provide guidance in assessing if a filtered right turn is appropriate, good engineering judgement must still be applied during each assessment.

3.7.7.2 Pedestrian Protection

Pedestrian protection shall be provided at all new and upgraded traffic signals

Unless otherwise specified, pedestrians at intersections should be protected as follows:

- Red arrow aspects installed for left turn traffic to provide partial protection (i.e. during the pedestrian walk time)
- Red arrow aspects installed for right turn traffic to provide full protection (i.e. the red arrow remains for the walk and clearance time)

At intersections with low pedestrian and vehicle volumes, protection may be provided using a delayed start for the conflicting vehicle movements

Protection is typically provided during part or all of the walk time, determined on a site by site basis as appropriate for the number of vehicle-pedestrian conflicts. At intersections with high pedestrian volumes where there is greater concern for pedestrian vulnerability, protection should be provided for the walk time and some or all of the clearance time for conflicting vehicles.

Full pedestrian protection should be considered at sites where an unusual layout causes vehicles to interact dangerously with pedestrians, and consideration needs to be given to conflicting movements to ensure capacity is not overly compromised.

Where a priority pedestrian crossing has no conflicting vehicle movements and is adjacent to a main vehicle movement, the pedestrian phase should allow late introduction of the pedestrian phase if sufficient time is available to complete the crossing within the associated vehicle phase.

3.7.7.3 Advanced vehicle detectors

Advanced detectors can be costly to install and maintain but typically provide efficiency and safety benefits. The suitability, number of detectors and their location shall be assessed on a site by site basis.

At new intersections, advanced detectors should generally be provided on arterial roads and any road with a posted speed limit above 50 km/h.

3.7.7.4 Network Operating Plan

The Hamilton Network Operating Plan covers day to day operation of the network in a way that seeks to optimise the existing infrastructure and reflects the strategic priorities that have been assigned to each of the user modes by location and time of day.

Any new or modified traffic signal site shall be assessed against the strategic intentions discussed in the Network Operating Plan to ensure that they will reflect the defined road user hierarchy and priorities.

3.7.8 Traffic Signal Procedure

The procedure set out in the table below applies to all Traffic signals that are to be managed by CTU, including traffic signals that are installed on other RCA networks such as the local State Highway network, Waipa District Council and Waikato District Council.

The table provides an overview of the entire process including the approvals and deliverables required to enable the traffic signals to be managed by CTU.

Table 3-18: Procedures: Signal Plans, Software and Commissioning

TASK	SUPPLY	DESCRIPTION / REQUIREMENTS	CREATED BY	APPROVED BY
Brief	Design brief	Design brief given to the signals consultant describing the traffic signal and civil works required	Client	Signals Consultant
Justification	Justification Report	Report justifying the need for traffic signal control	Signals consultant	Client
Design	Report, plan and traffic modelling	Design plans and design report in accordance with relevant standards. Level of service and 95%ile queue lengths for morning and evening peaks A site plan with the preliminary design superimposed showing:	Signals consultant	Client and City Transportation

TASK	SUPPLY	DESCRIPTION / REQUIREMENTS	CREATED BY	APPROVED BY
		<ul style="list-style-type: none"> - Posts, lanterns, Street lighting - Detectors - Controller - Road marking, signage and cycle facilities - Phasing diagram and cabling diagram - 5 Year CAS data 		
Peer review	Review report	<p>Peer review audit by external competent traffic signal designer, of design plan and design report</p> <p>Reviewer to supply letter of approval/memorandum with plan number once any amendments have been discussed and noted</p>	External design reviewer	Signals consultant and City Transportation
Final design	Drawings and estimate	<p>Final design plans including cable diagrams and phasing</p> <p>Schedule of quantities including cable charts</p> <p>Cost estimate</p> <p>Final design report</p> <p>Pre-construction Safety Audit covering Traffic Signals</p>	Signals consultant	Client Copy of Plans and Safety audit to City Transportation HCC for approval
Tender		<p>Tender documents, schedule, equipment and installation specification</p> <p>City Transportation to check technical documents.</p> <p>Appropriate references to the HCC ITS.</p>		
Controller	Controller Information Sheets (CIS)	<p>Controller Information Sheets (CIS) includes:</p> <ul style="list-style-type: none"> - Controller type - Lane layout - Detectors - Phasing - Signal group numbering - Timing details both vehicle and pedestrian - Pedestrian crossing distances - Flexilink details - Special facility requirements 	Signals consultant or council approved signal consultant	City Transportation for review
Controller	Controller software	<p>Controller Software including independent WinTraff test of PROM</p> <p>Bench testing of software must be carried out by the contractor prior to commissioning and</p>	Signals consultant or City Transportation nominated consultant Contractor for bench testing	City Transportation

TASK	SUPPLY	DESCRIPTION / REQUIREMENTS	CREATED BY	APPROVED BY
		completed bench form supplied (refer P43)		
Supervision	Supervision	Construction supervision / MSQA		Client or nominated rep
Connections	Connection for communications, cameras and power	<p>Communications: See Clause 3.6.4.</p> <p>The traffic signal controller must achieve continuous SCATS communications for a minimum of 48 hours prior to commissioning.</p> <p>Power: For sites within Hamilton a Wel networks connection form (www.wel.co.nz) must be filled in and a sent to newconnections@vircom-ems.co.nz (Contact energy) at least six weeks prior to commissioning. A copy must also be sent to the energy manager at Hamilton City Council for creation of new accounts. WEL Networks will provide an ICP and physical connection and return to Contact for the completion of the new connection</p>	Signals Contractor	City Transportation
SCATS	System set up and testing	SCATS graphics, related data and linking setup in accordance with HCC Traffic Signals Operational Standards Document	City Transportation	City Transportation
Pre commission checks	Completed site acceptance test (SAT)	Signals contractor shall complete the SAT (refer P43) in the presence of the RCA traffic signal representative (City Transportation)	Signals contractor	City Transportation
Commissioning	Authorisation to switch on the traffic signals	<p>Handover of new/upgraded signals to City Transportation to operate and manage.</p> <p>Signed SAT and written approval to switch on the traffic signals by the RCA traffic signals representative (City Transportation)</p> <p>Unless specific approval is given, commissioning shall not take place on a Friday or the day before a public holiday.</p>	City Transportation and Contractor	City Transportation
Asset information	Asbuilts and associated documentation	<p>Contractor to supply all required asset information as stated in P43, including:</p> <ul style="list-style-type: none"> - Final plans showing ducting and layout 	Signals contractor	Client and City Transportation

TASK	SUPPLY	DESCRIPTION / REQUIREMENTS	CREATED BY	APPROVED BY
		<ul style="list-style-type: none"> - RAMM Asset Collection Sheet - C&I sheet - Keys - Test certificates - Producer statements - Cable termination chart 		
Safety Audit	Post construction Safety Audit	<p>A post construction safety audit will be required at all new sites and upgraded signals that are complex or within high speed areas.</p> <p>Client may request a post construction safety audits following any traffic signal upgrades or modifications at their discretion.</p>	Qualified safety auditor	Client/City Transportation

3.8 QUALITY SYSTEMS

This section is intended to describe the formal testing and acceptance requirements of construction. The design portion of this document must be read and complied with fully.

3.8.1 Inspections and Acceptance

This section details the inspections and hold points where council acceptance is required before continuing. Site visits may be carried out at any time during construction. Specific details about testing measures are detailed in section 3.8.2.

3.8.1.1 Carriageway Construction Inspections

After completion of the subgrade, sub-base and basecourse layers, testing in accordance with clause 3.8.2.2 shall be carried out:

3.8.1.2 Hold Points

- Kerb and Channel
- Footpath and Cycleway
- Signs and other street furniture
- Street Lighting

The Installation contractor shall provide the following documentation to Council:

- a) Approved Application for New Connection
- b) Electrical Certificate of Compliance or Electrical Safety Certificate signed by authorised person
- c) As built drawings in format approved by the electrical network provider including results of inspections and testing.
- d) Street light control point form.
- e) Lighting pole and luminaire data using RAMM Streetlight Data Form F3.10.

- f) Network company's approval sheet

3.8.1.3 Traffic Signals

Traffic signals have a specific procedure set out in 3.7.8.

3.8.2 Testing Guidelines

The following are a summary of the testing requirements. The results of each of these tests must be provided to Council.

3.8.2.1 Carriageway Test Spacing

Compaction and material strength tests are to be taken at the following locations and frequency:

Table 3-19: Test Spacing locations and frequency

For carriageways 4.0m wide and less	Along centreline	15m spacing between tests
For carriageways between 4.0m and 8.0m	At the kerbside wheel tracks	Alternating Sides, 10 centreline metres between tests (20m repetition of testing rows)
For carriageways 8.0m and wider	At centreline and kerbside wheel tracks	Staggered across road, 10 centreline metres between tests (30m repetition of testing rows)

On small sites there must be a minimum of 10 tests carried out.

The kerbside wheel tracks are assumed to be 1m inside the kerb and channel alignment.

3.8.2.2 Subgrade Testing Prior to Design

Subgrade testing should begin at 100mm above the design subgrade level.

Subgrade testing is to be by Scala Penetrometer for all materials that are suitable.

If the material has larger aggregates then a Clegg Hammer test should be used instead.

3.8.2.3 Subgrade Testing Prior to Sub-base Construction

If subgrade improvement measures have been carried out (such as replacement with Pit Sand, Granular Rock Fill Material, or use of a stabilisation agent) Pit Sand or stabilised materials shall be tested by Scala Penetrometer. Granular rock shall be tested by Clegg Hammer.

The shape of the subgrade shall be measured by stringing.

3.8.2.4 Sub-base Testing

The compaction of sub-base shall be tested by Nuclear Densometer.

The thickness and shape of sub-base shall be measured by stringing. Clegg hammer testing is also required.

3.8.2.5 Basecourse Testing

The compaction of basecourse shall be tested by Nuclear Densometer.

The thickness and shape of basecourse shall be measured by stringing. Clegg hammer testing is also required.

3.8.2.6 Sealed Surface Testing

Just prior to the surface receiving its first surfacing coat, Benkelman beam testing shall be carried out.

3.8.2.7 Footpath Testing

Scala subgrade tests are to be carried out at 15m intervals along the length of the footpath.

3.8.2.8 Private Way Testing

As part of the compliance evidence for the construction of Private Ways, the forms are to be completed and submitted. See F3.11 on page 187.

3.8.2.9 Vehicle Crossings/Entranceways

A minimum of three scala penetrometer tests randomly spread shall be taken to a depth of 300mm below the final subgrade level per crossing. One test per 5m² on crossings greater than 15m² (kerb to boundary).

3.8.2.10 Kerb and Channel

If kerb and channel is constructed on top of the same sub-base pavement as the carriageway there are no additional subgrade or sub-base tests required.

If kerb and channel is constructed separate to the road, the base that the kerb and channel is founded on must be tested every 15m by Clegg Hammer (to sub-base standard). The pavement reconstruction adjacent to the kerb must be tested every 15m by Clegg Hammer prior to surfacing (to basecourse standard).

3.8.3 Testing Methods

3.8.3.1 Scala Penetrometer

The Scala Penetrometer shall only be employed where a significant part of the particles pass a 9.5mm sieve.

The CBR vs Penetration graph for sand silt materials is shown on [Drawing D3.2.2](#).

The cone is bedded into the soil with one (or more) blows. The zero point for depth and the number of blows is taken neglecting the bedding blows.

There are 2 methods of recording the results and all test sites must comply.

Table 3-20: Procedures

CBR	max mm/blow	min blows/100mm
7	32	3

10 (footpath and vehicle crossing subgrade)	23	4
15 (carriageway subgrade)	17	6

As a means of compliance for an acceptable CBR in carriageways at the insitu subgrade, the scala readings are averaged for the top 600mm. At the imported subgrade or lower subbase surface, the scala readings are averaged for the full depth of the pavement layer being tested.

For footpath and vehicle crossing subgrade testing, the results are the average of the top 300mm.

3.8.3.2 Lab Tested Soaked CBR

Subgrade samples from the site are to be tested by an IANZ accredited laboratory for their Soaked CBR (California Bearing Ratio).

3.8.3.3 Clegg Hammer

Where the Clegg Hammer is used, it shall be the Standard Australian Digital model with a 4.5 kg compaction hammer, using a drop height of 450 mm. The test certificate must be less than 12 months old.

Testing is carried out on a surface that has no loose material (removed by scuffing with a stiff hand broom). The maximum Clegg Impact Value (CIV) at the end of the 4th blow shall be recorded and the on-site CBR value shall be taken as $0.07 (CIV)^2$.

Table 3-21: Quality Systems Testing – Clegg Hammer Compliance Values

COMPLIANCE VALUES	CLEGG IMPACT VALUE (CIV)
Aggregate Subgrade (e.g. Granular rock fill material)	15
Subbase (trench reinstatement only)	25
Basecourse (trench reinstatement only)	40

3.8.3.4 Nuclear Densometer

Compaction testing shall be carried out by a suitably qualified operator using a calibrated Nuclear Densometer in Backscatter Transmission mode. The compaction is measured as a percentage of the Maximum Dry Density of the material.

The test spacings for nuclear densometer may be double the standard carriageway test spacings shown in Clause 3.8.2.1 with a minimum of 5 tests per site.

Table 3-22: Quality Systems Testing – Nuclear Densometer Compliance Values

COMPLIANCE VALUES	MINIMUM VALUE	AVERAGE (MEAN) VALUE
Subbase	92% MDD	95% MDD
Basecourse	95% MDD	98% MDD

3.8.3.5 Benkelman Beam Test

The surface shall be tested prior to sealing with a standard Benkelman Beam test apparatus. The organisation carrying out the tests shall have an IANZ accreditation.

The beam test shall be undertaken in accordance with NZTA's specification T/1 : Benkelman Beam Deflection Measurement except that the recordings for bowl deflection shall not be recorded or used in the deflection calculation.

Deflections conform to the target figures in Table 3-15 below. No more than 10% of the test results shall exceed the 90th Percentile and no single result shall exceed the maximum.

Table 3-23: Maximum Benkelman Beam Deflections

	AVERAGE (MM)	90TH PERCENTILE (MM)	MAXIMUM (MM)
A. On carriageways where asphalt is to be placed (with the exception of where asphalt is to be placed at cul-de-sac heads only):			
A1. Residential cul-de-sacs and private ways ≤40 household units	1.30	1.60	2.10
A2. All other carriageways up to 10 ⁵ EDA	1.10	1.35	1.80
A3. All carriageways between 10 ⁵ and 10 ⁶ EDA	1.00	1.20	1.60
B. On other carriageways surfacing situations (factored by 1.5 for block paving):			
B1. Residential cul-de-sacs and private ways ≤40 household units	1.50	1.80	2.40
B2. All other carriageways up to 10 ⁵ EDA	1.25	1.50	2.60
B3. All carriageways between 10 ⁵ and 10 ⁶ EDA	1.00	1.20	1.60

Table 3-24: Shape and Relative Height Tolerances

AT TOP OF LAYER	CENTRELINE AND NEAR PAVEMENT EDGE	AT CHANNEL EDGE	DEVIATION FROM 3M STRAIGHT EDGE OR CAMBER BOARD
Surface			1: 12mm 2: 8mm
Basecourse	-5mm to +15mm	1: 0mm to +10mm	12mm
Subbase	-25mm to +5mm	-25mm to +5mm	15mm
Subgrade	-30mm to 0mm	-30mm to 0mm	15mm

1: Chip sealed surface

2: Asphalt surface (typically 25mm thick)

Construction levels are based on lip of channel, appropriate crossfall and designed pavement layer thickness.

3.8.3.6 NAASRA Roughness

A post sealing NAASRA roughness measure is required. This measure shall be 70 maximum average value with no more than 3% readings in excess of 70 for each traffic lane. The Engineer will not consider remedial measures other than remaking of the pavement surface for NAASRA roughness compliance. The survey result is required to be provided prior to the issue of a practical completion certificate or 224C.

Roughness Specification

All road roughness surveys shall be in accordance with the latest revision of the "RAMM Computer User's Manual", "RU Technical Recommendation TR12 Roughness Meter Guidelines" and "Standard Operating Instructions for the NAASRA Roughness Meter" or the RIMS "Specification for Road Condition Data Collection". All results are to be reported as NAASRA counts.

The Project Manager and test operators shall be suitably experienced and familiar with the test equipment and results required.

Measurements are to be taken on the various road types as follows:

- On narrow single carriageway roads measurements are to be taken in the normal driven wheel path. This is likely to straddle the road centre-line. The survey is to be completed in one direction only. Data processing techniques should account for instances when the vehicle deviates from the road onto the shoulder.
- On single carriageway, two-lane roads both increasing and decreasing lanes are to be measured. The measurements are to be taken in the wheel paths. Where no obvious wheel path is visible the measurements are to be taken 50 to 70 cm from the edge of the pavement.
- On divided carriageway roads and service lanes survey both increasing and decreasing lanes (both carriageways and service lanes). The measurements are to be taken in the wheel paths; where no obvious wheel path is visible the measurements are to be taken 50 to 70 cm from the edge of the pavement.
- On dual carriageway roads survey both increasing and decreasing lanes (both carriageways). The measurements are to be taken in the most heavily trafficked wheel paths; where no obvious wheel path is visible the measurements are to be taken 50 to 70 cm from the edge of the pavement.

Laser Profilometer

The Consultant may use a non-contact laser profilometer to measure the paved roads' longitudinal profile. The profilometer should conform to the ASTM E950-94 standard, have a vertical resolution of less than 0.1 mm, and achieve a roughness measurement accuracy of < 0.1 mm. The Consultant shall record and report the longitudinal profile data and process the profile data to provide and report NAASRA count/km. The lane roughness calculations are made from the average of the left and right wheel path profiles, and the data recorded and reported as follows:

- Number of wheel paths: two
- Longitudinal profile sampling interval: no more than 25 mm
- NAASRA Counts interval 20 m and 100 m.

Any factors which may influence the survey result must be recorded during the survey and the data corrected accordingly. These factors include, for example, survey speed in congested areas, traffic congestion, sudden braking, and other events.

Some operational practices, such as sudden acceleration or braking during surveys, may also influence the result and operators should avoid these.

Response Type Roughness Meter

The roughness data may be collected using a single/dual response-type roughness meter/s or similar, with the instrument calibrated in accordance with ASTM E 1448-92/98. The roughness data must be reported at 20 m and 100m intervals in NAASRA count/km. The vehicle speed shall be recorded during the survey and taken into account when calculating the roughness from the raw data.

Factors which may influence data quality must be recorded during the survey and the data corrected accordingly. These include, for example, traffic congestion, pavement construction activities and having to travel off the carriageway.

Equipment Validation

Roughness measurement equipment with current NZTA approval for use on the State Highway network may be used without further validation checks. Other equipment must be validated before use as described in the RIMS High Speed Data Collection Guidelines.

3.8.4 As-built Data Provision

As built data requirements are detailed in [Section 1](#), Table 1-9.

APPENDIX 3A: TRANSPORTATION CORRIDOR HIERARCHY TABLES

Following are links to the transportation corridor hierarchy tables for each participating council:

Table 3-25: Transportation corridor hierarchy tables

COUNCIL	WHERE CURRENTLY HELD	LINK
Hamilton City Council	District Plan	http://www.hamilton.govt.nz/our-council/council-publications/districtplans/PODP/appendix15/Pages/default.aspx
Waikato District Council	District Plan	http://districtplan.waidc.govt.nz/pages/plan/Book.aspx?exhibit=ws&hid=1445
Waipa District Council	District Plan	T4 - Criteria for Public and Private Roads.pdf
Matamata Piako District Council	Development Manual, Page 3-2, Table 3.1	http://www.mpdc.govt.nz/districtplan/DevelopmentManual/DevelopmentManual2015.pdf
Hauraki District Council	District Plan	http://www.hauraki-dc.govt.nz/assets/council_documents/dptext/1252639_Sect8.6.pdf
South Waikato District Council	CoP Urban roads Page 93, Table 4	http://www.southwaikato.govt.nz/our-services/planning/Documents/COP/code_of_practice_subdivisions_part_7.pdf
	CoP Rural roads Page 112, Figure 12	http://www.southwaikato.govt.nz/our-services/planning/Documents/COP/code_of_practice_subdivisions_appendices.pdf
Otorohanga District Council	District Plan	http://www.otodc.govt.nz/assets/Uploads/ODC-Operative-District-Plan-On-Line-Version2.pdf
Waitomo District Council	N/A	

APPENDIX 3B: TRANSPORTATION ASSET DATA FORMS

Table 3-26: Transportation Asset Data Forms

NO.	TITLE
Quality Forms	
F3.1	Basecourse Shape and Relative Height/Clegg Hammer Test and NDM Checklist
F3.2	Sub-base Shape and Relative Height/Clegg Hammer Test Checklist
F3.3	Subgrade Shape and Relative Height/Scala Penetrometer Test Checklist
F3.4	As-built Data Checklist
F3.5	Subgrade Scala Penetrometer Data Form
F3.6	Trench Backfill Compaction Form
RAMM Forms	
F3.7	Asphalt Data
F3.8	Chipseal Data
F3.9	Pavement Data
F3.10	Street Light Data
F3.11	Privateway – confirmation of Design, Supervision and Construction
F3.12	Privateway construction materials

F3.1 BASECOURSE SHAPE AND RELATIVE HEIGHT / CLEGG HAMMER TEST / NDM (CIRCLE ONE TEST)

SUBDIVISION	STAGE	
PLAN NO.	CH FROM	TO
TEST LOCATION	ROAD NAME/NUMBER	
CONTRACTOR	DATE	

CH	1.0M FROM K&C (L)	CENTRELINE	1.0M FROM K&C (R)	KERB SIDE WHEEL TRACKS	
				LEFT	RIGHT

F3.1 ANALYSIS OF RESULTS

Basecourse Shape / Clegg Hammer Test Completed (Circle one test).	
Clegg Hammer results attached <input type="checkbox"/>	

<input type="checkbox"/>	Pass	Ch. from:		to:	
<input type="checkbox"/>	Fail	Ch. from:		to:	
<input type="checkbox"/>	Remedial work required		Date of calibration		
<input type="checkbox"/>	Contractor's control Offset pegs or Grader GPS				
<input type="checkbox"/>	NDM Results attached		Dry density used:		

Comments/Required Remedial Work

Signature of Developer/Contractor

Signature of Council Representative

F3.2 SUBBASE SHAPE AND RELATIVE HEIGHT / CLEGG HAMMER TEST (CIRCLE ONE TEST)

SUBDIVISION	STAGE	
PLAN NO.	CH FROM	TO
TEST LOCATION	ROAD NAME/NUMBER	
CONTRACTOR	DATE	

CH	1.0M FROM K&C (L)	CENTRELINE	1.0M FROM K&C (R)	KERB SIDE WHEEL TRACKS	
				LEFT	RIGHT

F3.2 ANALYSIS OF RESULTS

Sub-base Shape / Clegg Hammer Test Completed (Circle one test).	
Clegg Hammer results attached <input type="checkbox"/>	

<input type="checkbox"/>	Pass	Ch. from:		to:	
<input type="checkbox"/>	Fail	Ch. from:		to:	
<input type="checkbox"/>	Remedial work required		Date of calibration		
<input type="checkbox"/>	Contractor's control Offset pegs or Grader GPS				
<input type="checkbox"/>	NDM Results attached		Dry density used:		

Comments/Required Remedial Work

Signature of Developer/Contractor _____

Signature of Council Representative _____

F3.3 SUBGRADE SHAPE AND RELATIVE HEIGHT/ SCALA PENETROMETER TEST

SUBDIVISION	STAGE
PLAN NO.	CH FROM TO
TEST LOCATION	ROAD NAME/NUMBER
CONTRACTOR	DATE

CH	1.0M FROM K&C (L)	CENTRELINE	1.0M FROM K&C (R)	KERB SIDE WHEEL TRACKS	
				LEFT	RIGHT

F3.3 ANALYSIS OF RESULTS

Sub-grade Shape / Scala Penetrometer Test Completed (Circle one test).	
Scala penetrometer test sheet attached <input type="checkbox"/>	

<input type="checkbox"/>	Pass	Ch. from:		to:	
<input type="checkbox"/>	Fail	Ch. from:		to:	
<input type="checkbox"/>	Remedial work required				
<input type="checkbox"/>	Contractor's control Offset pegs or Grader GPS				

Comments/Required Remedial Work

Signature of Developer/Contractor _____

Signature of Council Representative _____

F3.4 AS-BUILT DATA CHECKLIST

The following are the as-built data requirements to be met:

DRAWINGS

Drawings must show the following in a clear and uncluttered way:

- Design centreline and chainage
- Clear indication of the area corresponding to the GST register
- Surfacing Changes and types (e.g. cobbled sections, surfacing joins)
- Typical Cross Section (carriageway width, pavement, surfacing, footpath etc.)
- Footpaths
- Traffic Islands
- Parking / Bus Bays
- Streetlighting Location (with differing symbols for streetlight types)
- Tactile Pavers / Signage / Cycle Parking / Bollards
- Kerb and Channel, Catchpits and other drainage related assets
- Any assets that have been removed or made redundant (e.g. Road Stopping, Streetlight Relocations).

Additional details are required for:

1. Subsoil Drains, Soak Holes, Soak Trenches & Culverts (less than 3.4m²)
 - As-built drawings
 - Material
 - Dimensions
2. Structures, including retaining walls in or bordering the road reserve >1m high, bridges, culverts (greater than 3.4m²), underpasses and any other miscellaneous structures. The following must be provided;
 - Construction Drawings
 - As-built Drawings
 - Producer Statements and Code of Compliance (if applicable)
 - Any applicable guarantees and warranties
 - Recommended Maintenance Schedule

F3.4 AS-BUILT DATA CHECKLIST

3. Stormwater Management Plans (where there is only a transportation asset and not stormwater) for:
 - Swale maintenance schedule
 - Detention pond maintenance schedule
 - Overland flow path maintenance schedule
 - Soakage pit observation bore inspection

4. Detail Sheets for:
 - Asphalt or chipseal surfacing (including chipseal stone PSV testing sheet)
 - Pavement
 - Streetlights

DOCUMENTS AND FORMS

1. Structures, including bridges, culverts (greater than 3.4m²), underpasses and any other miscellaneous structures
 - Producer statements (PS3)
 - Applicable guarantees and warranties
 - Recommended maintenance schedule

2. Streetlighting
 - Network company's approval
 - Electrical Certificate of Compliance
 - Manufacturer warranty documents for lights, columns and coatings

3. As-built information, including:
 - Streetlight data forms
 - Pavement data forms
 - Asphalt or chipseal data forms

Signature of Developer/Contractor _____

F3.5 SUBGRADE SCALA PENETROMETER DATA FORM

Scala penetrometer testing of subgrade materials to determine consistency.

Company Name _____

Tester Name _____

Subdivision Name and Stage _____

Testing Date _____

Testing Results

Road Name		
Displacement		
Location	Center / Left / Right / Footpath	Center / Left / Right / Footpath
Blows top 100mm		
Blows 100 to 200mm		
Blows 200 to 300mm		
Road Name		
Displacement		
Location	Center / Left / Right / Footpath	Center / Left / Right / Footpath
Blows top 100mm		
Blows 100 to 200mm		
Blows 200 to 300mm		
Road Name		
Displacement		
Location	Center / Left / Right / Footpath	Center / Left / Right / Footpath
Blows top 100mm		
Blows 100 to 200mm		
Blows 200 to 300mm		

F3.6 TRENCH BACKFILL COMPACTION FORM

(to be completed for excavation reinstatement)

As per the National Code of Practice for Utility Operators, sections 5.5.4 and 5.5.5

Clegg Hammer testing is required for Carriageway Basecourse and Sub-base layers, Driveways and Footpaths prior to surfacing.

The target results are:

Carriageway Basecourse CIV 40

Carriageway Sub-base or Driveways CIV 35

Footpaths CIV 25

Where the excavated area is greater than 0.5m² and less than 5m², one test is required, or for larger excavations, one test per 5m². For backfilling within the carriageway, testing must be carried out for each backfilled layer.

Company Name _____

Tester Name _____

CAR Number _____

Testing Results

Test Date

Road Name			
House Number / Location			
Layer (circle one)	Sub-base / Basecourse / Driveway / Footpath	Sub-base / Basecourse / Driveway / Footpath	Sub-base / Basecourse / Driveway / Footpath
Clegg Impact Value			

Test Date

Road Name			
House Number / Location			
Layer (circle one)	Sub-base / Basecourse / Driveway / Footpath	Sub-base / Basecourse / Driveway / Footpath	Sub-base / Basecourse / Driveway / Footpath
Clegg Impact Value			

Test Date

Road Name			
House Number / Location			
Layer (circle one)	Sub-base / Basecourse / Driveway / Footpath	Sub-base / Basecourse / Driveway / Footpath	Sub-base / Basecourse / Driveway / Footpath
Clegg Impact Value			

F3.7 RAMM ASPHALT DATA

(to be completed for each seal layer on each road section)

Subdivision _____

Road No / Name _____

Start m _____ Start Description _____

End m _____ End Description _____

Width _____

Contractor _____

Date of Work _____

Asphalt Type (circle one) AC / OGPA / SMA / Other

Grading (e.g. M/10 DG10) _____

Area Surfaced (m²) _____

Average thickness (mm) _____

Laying Temperature (°C) _____

Tack Coat Residual Application Rate (L/m²) _____

Additional Notes (e.g. Weather, Temp, Polymer Modification)

F3.8 RAMM CHIPSEAL DATA

(to be completed for each seal layer on each road section)

Subdivision	_____
Road No / Name	_____
Start m	_____ Start Description _____
End m	_____ End Description _____
Width	_____
Contractor	_____
Date of Work	_____
Seal Type (circle one)	_____ 1 Coat / Racked in Chipseal / 2 Coat / Other: _____
Seal Reason	_____ Waterproofing First Coat / Second Coat / Asphalt Membrane _____
Area Sealed (m ²)	_____
Chip Grading (e.g. 3/5)	_____
Binder Type (e.g. B180/200)	_____
Chip Source Company	_____
Chip Source Quarry	_____
Total Volume of Binder Used (Hot) (Litres)	_____
Temperature of Binder (°C)	_____
Residual Binder Rate (L/m ²)	_____
Cutter (e.g. 3 pph Kero)	_____
Other Additives with concentrations (e.g. Polymer modification RS1, 3%)	_____

Sealing Notes (e.g. Weather, Temp)	_____

Surfacing Chip PSV testing form attached

F3.9 RAMM PAVEMENT DATA

(to be completed for each road section)

Subdivision _____

Road No / Name _____

Start m _____ Start Description _____

End m _____ End Description _____

Width _____

Basecourse

Date Completed _____

Thickness _____

Grading _____

Quarry _____

Sub-Base

Date Completed _____

Thickness _____

Grading _____

Quarry _____

Undercut / Imported Subgrade (If Required)

Whole Site Yes / No

Length _____

Width _____

Depth _____

Backfill Material _____

Subgrade

CBR Without _____

Stabilisation _____

Material _____

Stabilised? No / Cement / Lime

% Stabilising Agent _____

Stabilised Depth _____

Stabilised CBR _____

F3.10 RAMM STREETLIGHT DATA

(to be completed for each change in streetlight type)

Subdivision and stage/Contract _____

Number of street lights of this type _____

General

Date Installed _____

Control Type _____ Network Streetlight Feed / Photocell / Other:

Origin of Power Supply _____ Streetlight Circuit / Metered Power Supply

Light

Manufacturer _____

Model _____

Total Power Consumption (W) _____

Light Height (m) _____

Tilt Angle (° Degrees) _____

Outreach

Outreach Type _____ Curved / Mitre / Other Decorative:

Outreach Distance (m) _____

Pole

Manufacturer _____

Type _____ Octagonal / Circular / Power / Other Decorative:

Pole Height (m) _____

Material _____ Galvanised Steel / Steel / Other:

Coating _____ N/A / Painted / Powder Coated

Colour (if coated) _____

Mounting _____ Frangible ground plant / Shear Base

- Manufacturer's Warranty documents for Poles, Lights and Coatings attached.
- Shown on as-built drawings.

F3.11 PRIVATEWAY – CONFIRMATION OF DESIGN, SUPERVISION AND CONSTRUCTION

(One form for each privateway or access lot on consent)

File Number:

Applicant's Name			
Applicant's Address			
CP Engineer's Name			
CP Engineer's Address			
Subdivision Name			
Subdivision Address			
Number of Privateways		Number/Reference	

DRAINAGE TO PRIVATEWAY (TYPE OF DRAINAGE)

Soakpits	Number	
Results of Percolation Tests		

Piped system	Number of sumps	Pipe Size and Length	
		LHS	RHS
Watertables	Meterage		
Outlet Location and Details (to meet Waikato Regional Council drainage requirements)			

Other (please specify)	

The Privateway and entrance to the Privateway detailed meets all the specifications and requirements of the RITS and all the Resource Consent conditions relating to the Privateway in the consent approval dated

Signature of Chartered Professional Engineer _____

Any uncompleted items will be assumed as non-complying.

F3.12 PRIVATEWAY CONSTRUCTION MATERIALS

Materials used – type and depths (e.g. GAP/WHAP/TNZ M4/Brown Rock/Pitsand)

Basecourse	Material		Design	
	Depth		Actual	
Subbase	Material		Design	
	Depth		Actual	
Subgrade	Material		Design	
	Depth		Actual	
Subgrade	CBR		Test Method	

Compaction during construction

Tests Used	Target	Result
Subbase		
Basecourse		

Sealing (two coat seal to be provided based on 15 years minimum life span)

Date of Seal		Grade of Bilumen	
Grade of Chips		Application Rates	

Where structures involved (e.g. bridge, culvert, well)

Name and Company of Design Engineer
Materials used (i.e. steel/precast RC/insitu RC/gabion)
Name of Supervising Engineer

The Privateway and entrance to the Privateway detailed meets all the specifications and requirements of the RITS and all the Resource Consent conditions relating to the Privateway in the consent approval dated

Signature of Chartered Professional Engineer _____

Any uncompleted items will be assumed as non-complying.

APPENDIX 3C: DRAWINGS

Table 3-27: Drawing Register

DRAWING NO	TITLE
D3.1.1	Terminology
D3.1.2	Roading Terminology
D3.1.3	Location of Services in Transport Corridor
D3.1.4	Cross Section Details Typical Berms
D3.1.5	Boundary Splay
D3.1.6	Standard Residential Private ways
D3.1.7	Cul-de-Sac Head
D3.1.8	On Street Parking Dimensions and Setout
D3.2.1	Normal Carriageway Camber and Construction Tolerances
D3.2.2	C.B.R. v Penetration Graphs for Hamilton Sand Silt Materials
D3.2.3	Trench Reinstatement
D3.3.1	Vehicle Crossing and Pedestrian Cutdown Set Out
D3.3.2	Vehicle Crossing Profiles
D3.3.3	Kerb and Channel Profiles
D3.3.4	Rural Entranceways – Residential, Light and Heavy Commercial)
D3.3.5	Cross Section Details for Footpath, Vehicle Crossings and Depressed Kerb and Channel
D3.3.6	Cross Section Details Associated Kerb and Channel Reinstatement Within Existing Pavement
D3.3.7	Concrete Vehicle Slot Crossings
D3.3.8	Accessible Bus Stop
D3.4.1	Location of Subsoil Drainage
D3.5.1	A/C, SMA and OGPA Overlay Details
D3.5.2	A/C Overlay V-Ramp Detail
D3.6.1	Timber Edging Details for Chip Seal, Asphalt and Block Paving
D3.6.2	Pedestrian Crossing Point Location at Intersections
D3.6.3	Tactile Paving for Vision Impaired
D3.6.4	Pedestrian Facilities in Islands
D3.7.1	Sign Location and Visibility At Intersections
D3.7.2	Street Name Signs Arterial/Collector Intersection
D3.7.3	Street Name Signs Arterial or Collector Intersection with Local Roads
D3.7.4	Street Name Signs Local/Local Intersections
D3.7.5	Cycle Signage for Off Road Cycle Paths
D3.7.6	Neighbourhood Watch Signage
D3.7.7	Drawing deleted
D3.7.8	Drawing deleted
D3.7.9	Ground Sockets for Removable Poles
D3.7.10	Installation of Chevron or Route and Low Level Road Name Sign
D3.7.11	Attachment of Street Name Sign Blades to Poles

DRAWING NO	TITLE
D3.7.12	Street Name Plate
D3.7.13	Kea Crossing Flag
D3.7.14	Kea Crossing Flag Pole
D3.7.15	School Patrol Signs
D3.7.16	Bus Stop / Taxi Supplement
D3.7.17	Through Truck Route Marker
D3.7.18	Drawing deleted
D3.7.19	Drawing deleted
D3.7.20	Drawing deleted
D3.7.21	Drawing deleted
D3.7.22	Drawing deleted
D3.8.1	CBD Cycle Rack
D3.8.2	Bike Rack – Ribbon Style
D3.8.3	Bike Rack – Hoop Style
D3.8.4	Drawing deleted
D3.8.5	Wooden Bollard see D7.7
D3.8.6	Lockable Removable Bollards
D3.8.7	CBD Pedestrian Barrier
D3.8.8	Pedestrian Balustrade Barrier
D3.8.9	Pedestrian Barriers
D3.8.10	Pedestrian Accessway Fence Detail
D3.8.11	Pedestrian Handrail or Walkway Barrier
D3.8.12	Concrete Base Details for Steel Litter Bins
D3.8.13	Standard 3.5m Bus Shelter Foundation Detail
D3.8.14	Bus Shelter and Mini Bus Shelter
D3.8.15	Bus Stop Seat – No Shelter
D3.9.1	Typical Cycle Advance Stop Lines Layout
D3.9.2	On Road Cycle Lane Connection to Off Road Shared Path
D3.9.3	Clearway and P5 Roadmarking
D3.9.4	Mobility Cardholders Parking
D3.10.1	Roundabout Details
D3.10.2	Flush Threshold (for maintenance purposes only)
D3.10.3	Paved Raised Pedestrian Ramp (for maintenance purposes only)
D3.10.4	Concrete Raised Pedestrian Ramp (for maintenance purposes only)
D3.10.5	Asphaltic Concrete Tapered Raised Pedestrian Ramp
D3.10.6	Asphaltic Concrete Full Width Raised Pedestrian Ramp
D3.10.7	Full Width Raised Pedestrian Threshold – Imprint Patterns and Coloured Surfacing
D3.11.1	Pedestrian Belisha and Warning Globe Detail
D3.11.2	Pedestrian Belisha and Floodlighting
D3.11.3	Drawing moved to Appendix C as D.3.C2

DRAWING NO	TITLE
D3.12.1	Traffic Signal Ducting Under-Kerb Access Details
D3.12.2	Fold Down Traffic Signal Pole
D3.12.3	Removable Traffic Signal Pole
D3.12.4	Standard Dimensions for Stop Line Detectors and Advanced Cycle Stop Box
D3.12.5	Drawing deleted
D3.12.6	Street Name Signs at Signalised Intersections
D3.12.7	Traffic Controller Base, Signal Pole and Mast Arm

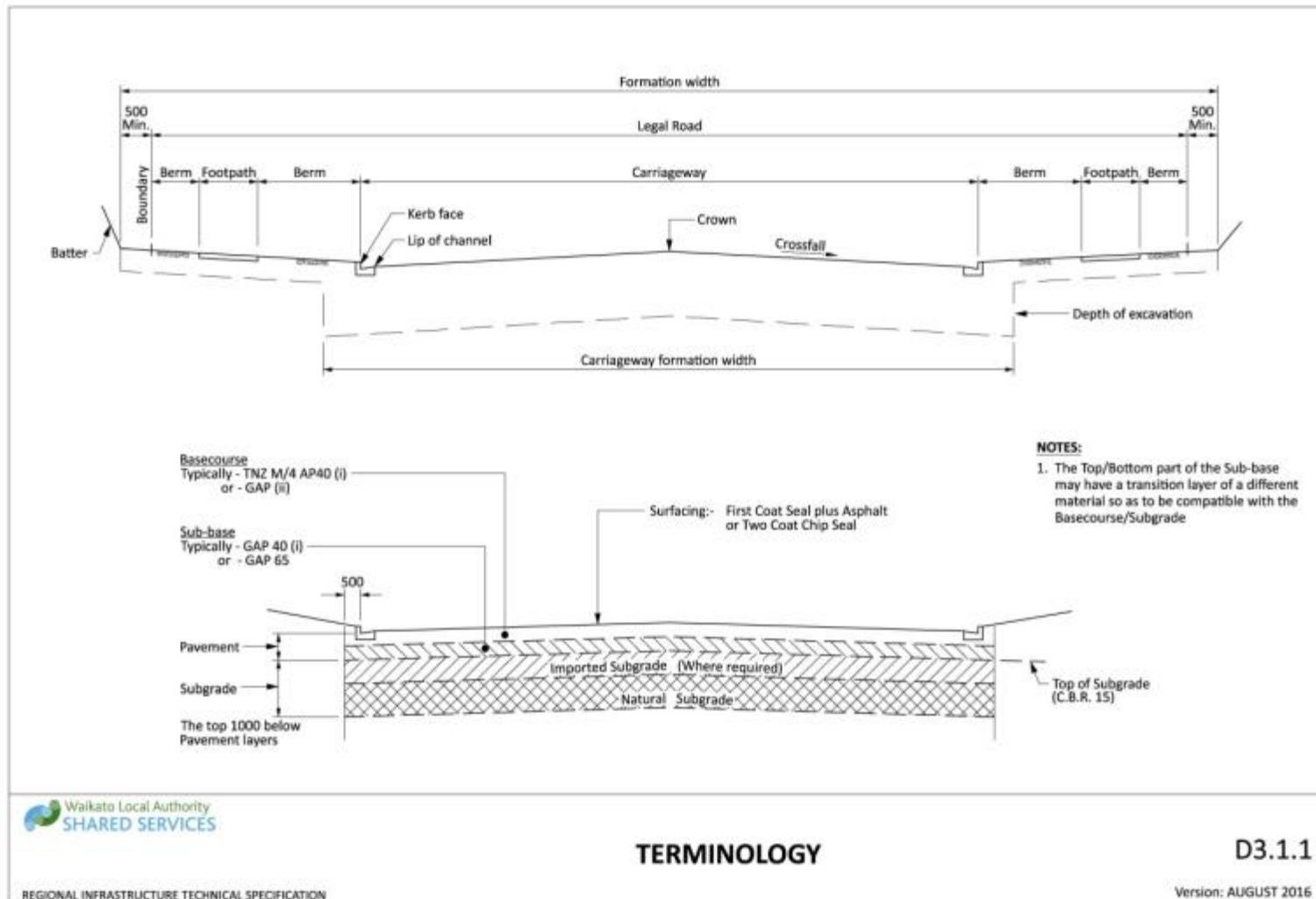

Drawing 3-2: Terminology

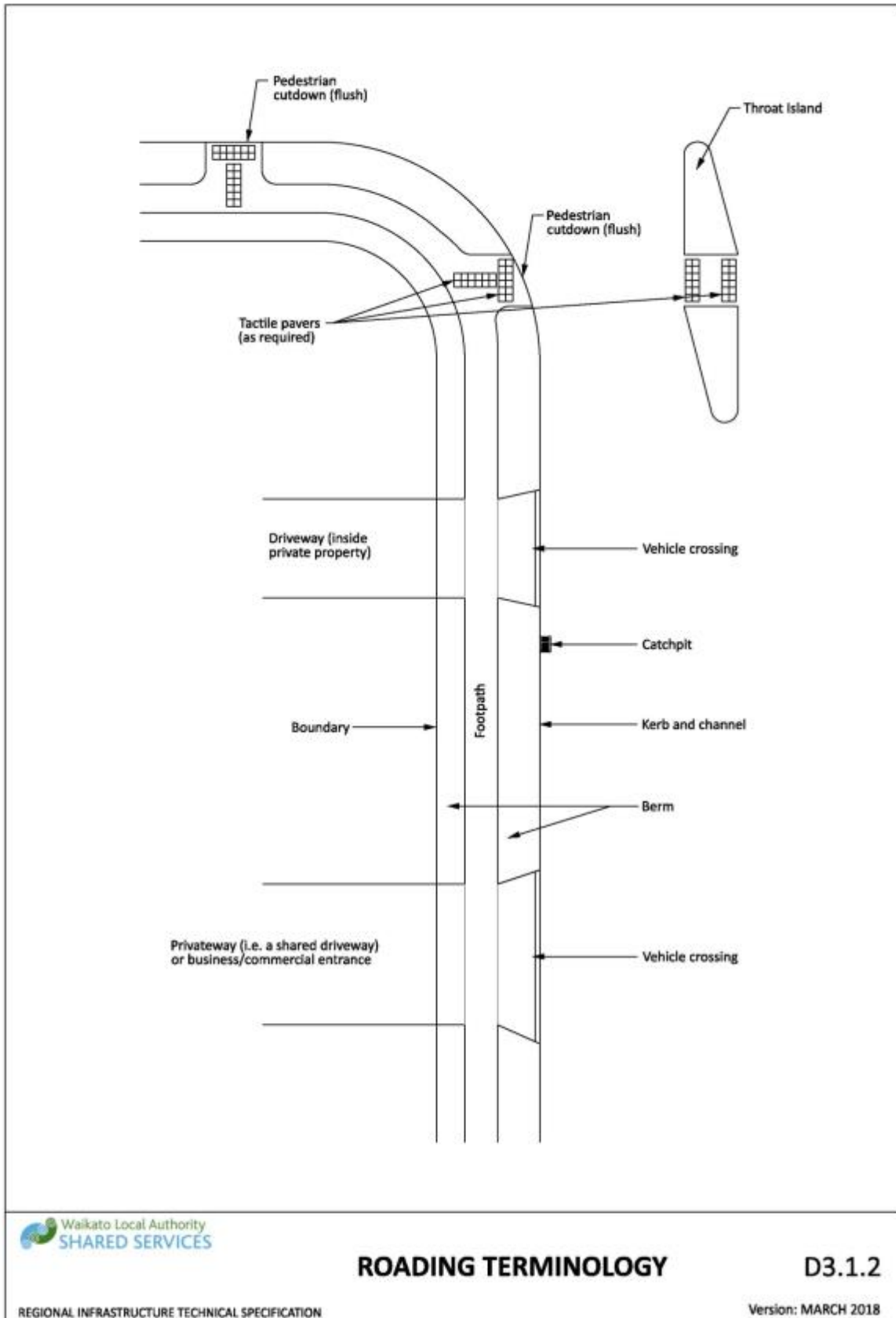

Drawing 3-3: Roading terminology

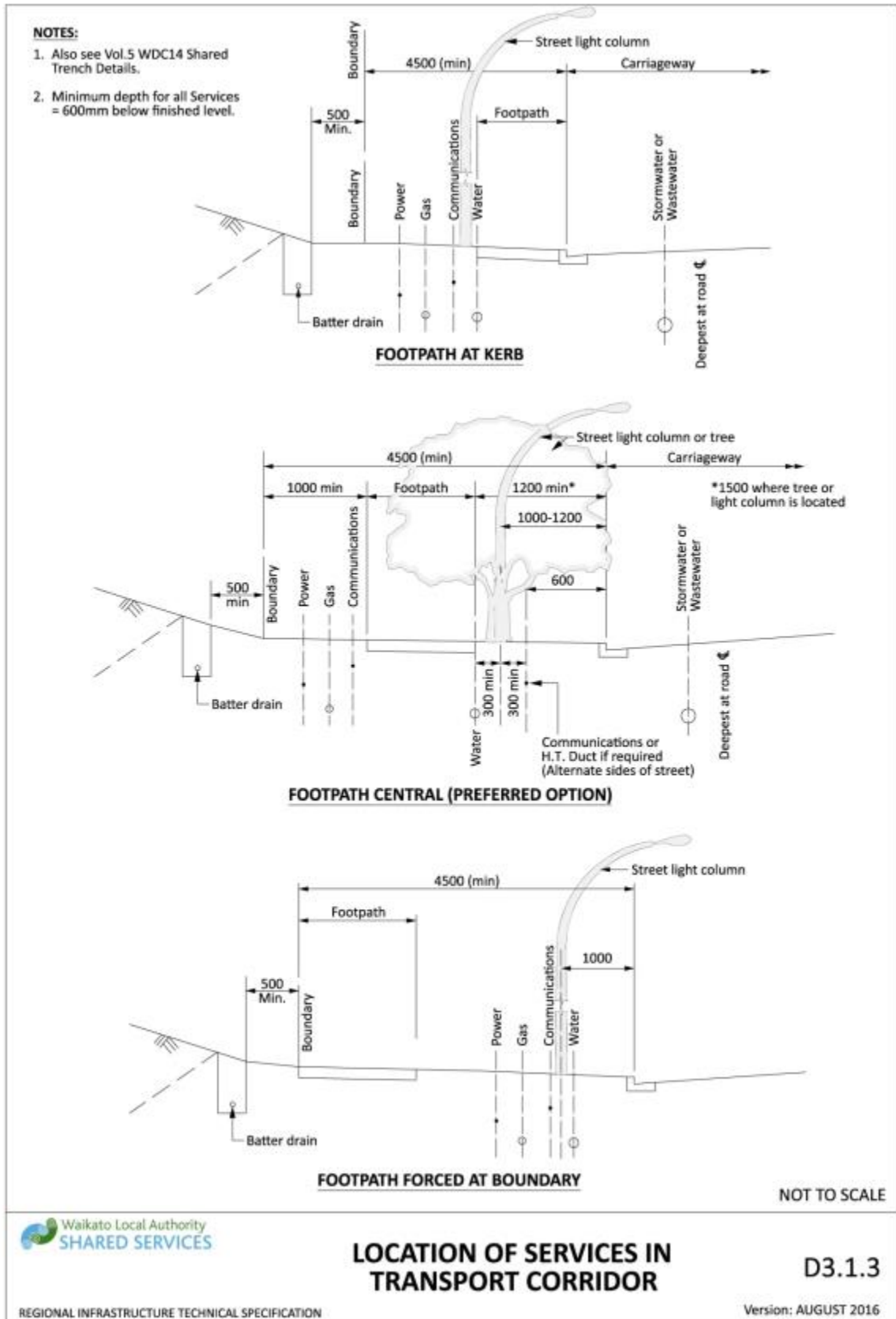

Drawing 3-4: Location of services in transport corridor

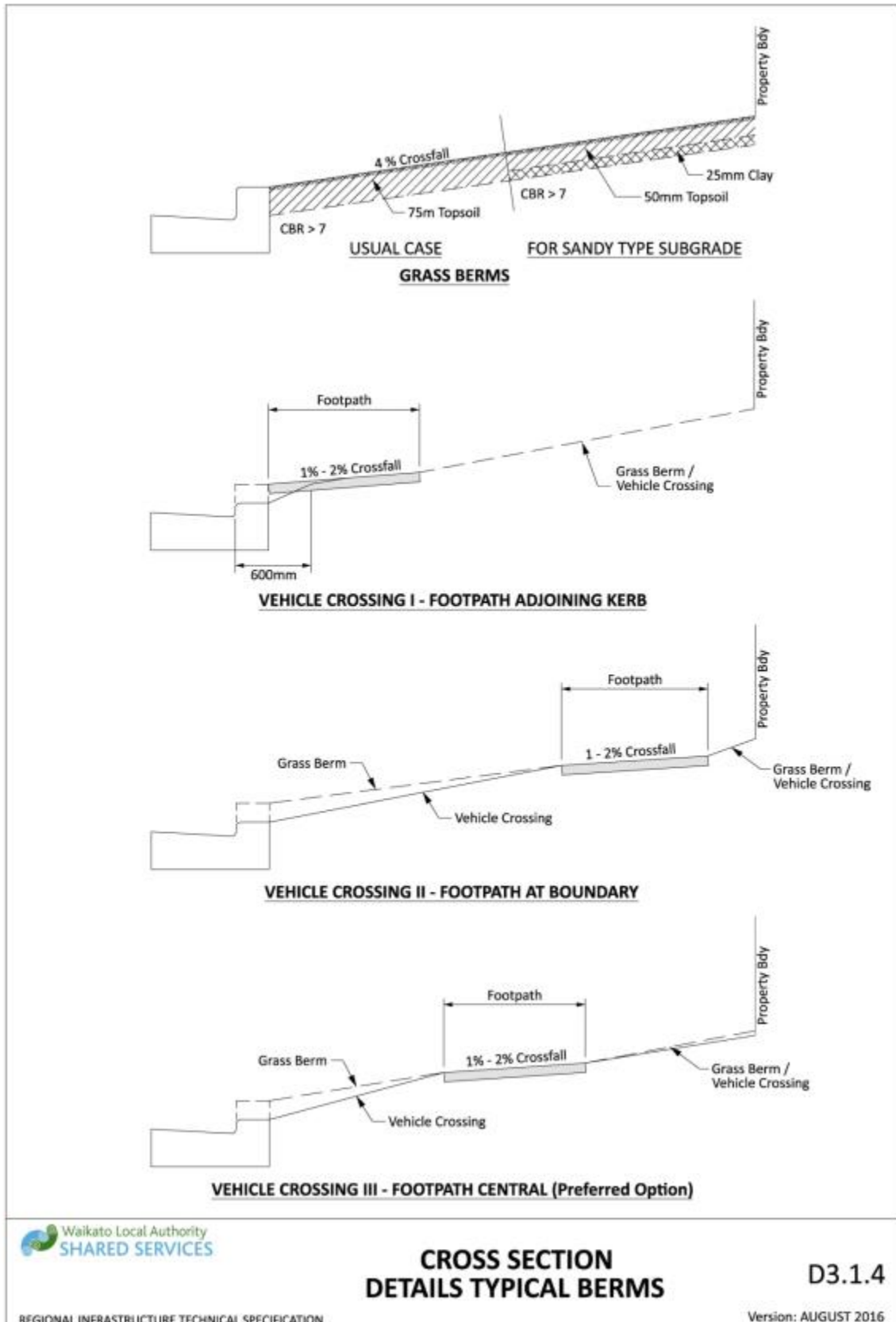

Drawing 3-5: Cross section details typical berms

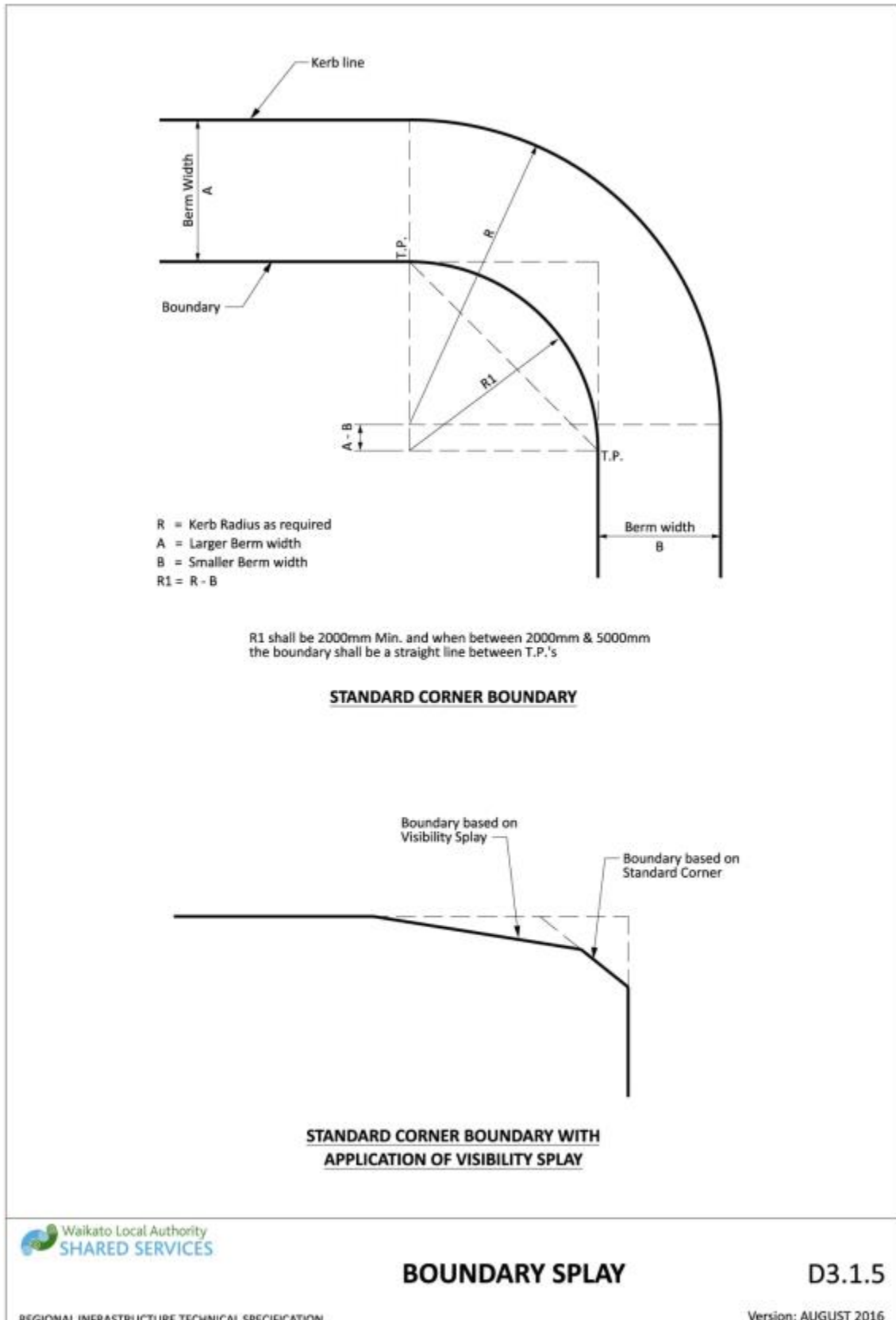

Drawing 3-6: Boundary splay

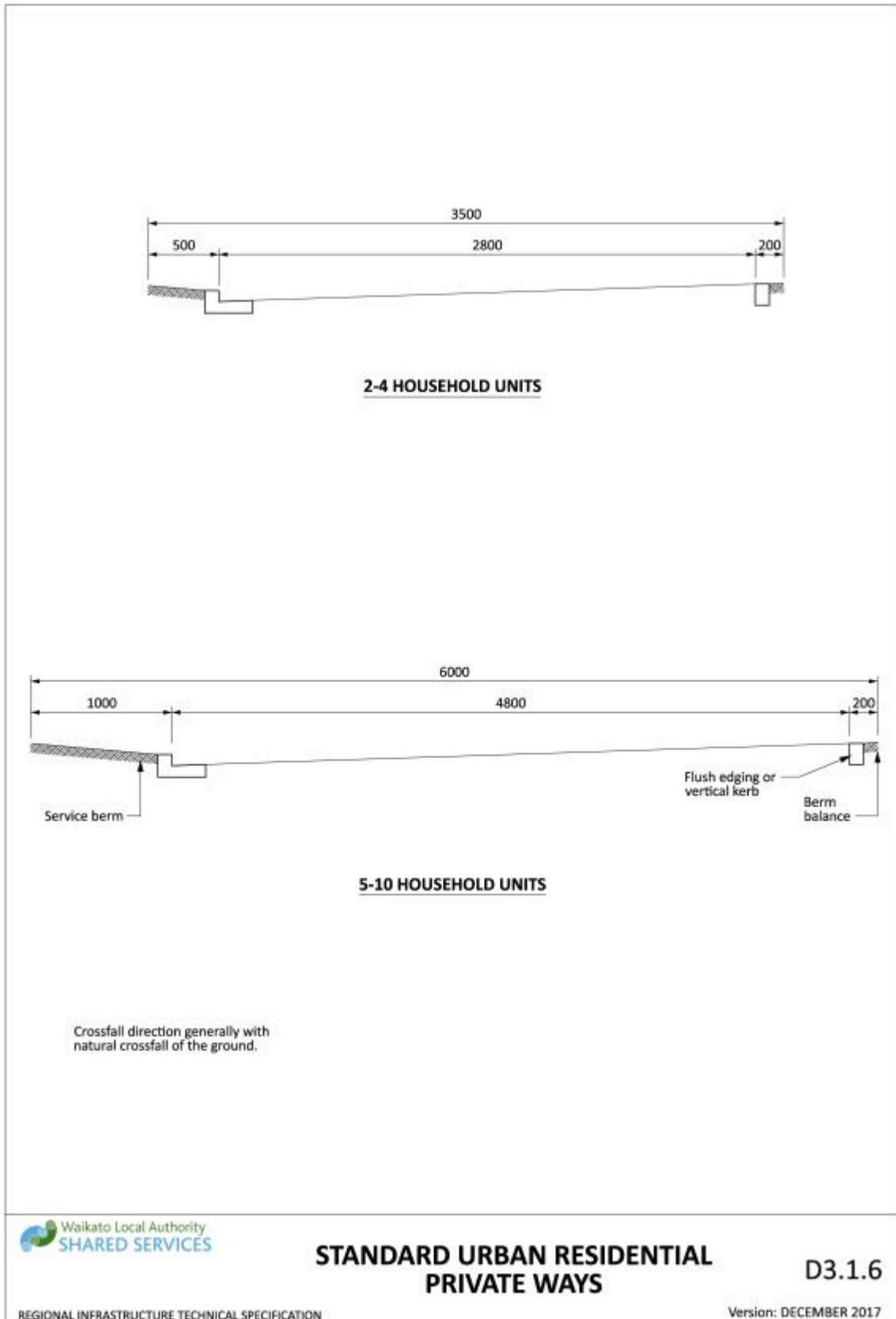

Drawing 3-7: Standard residential privateways

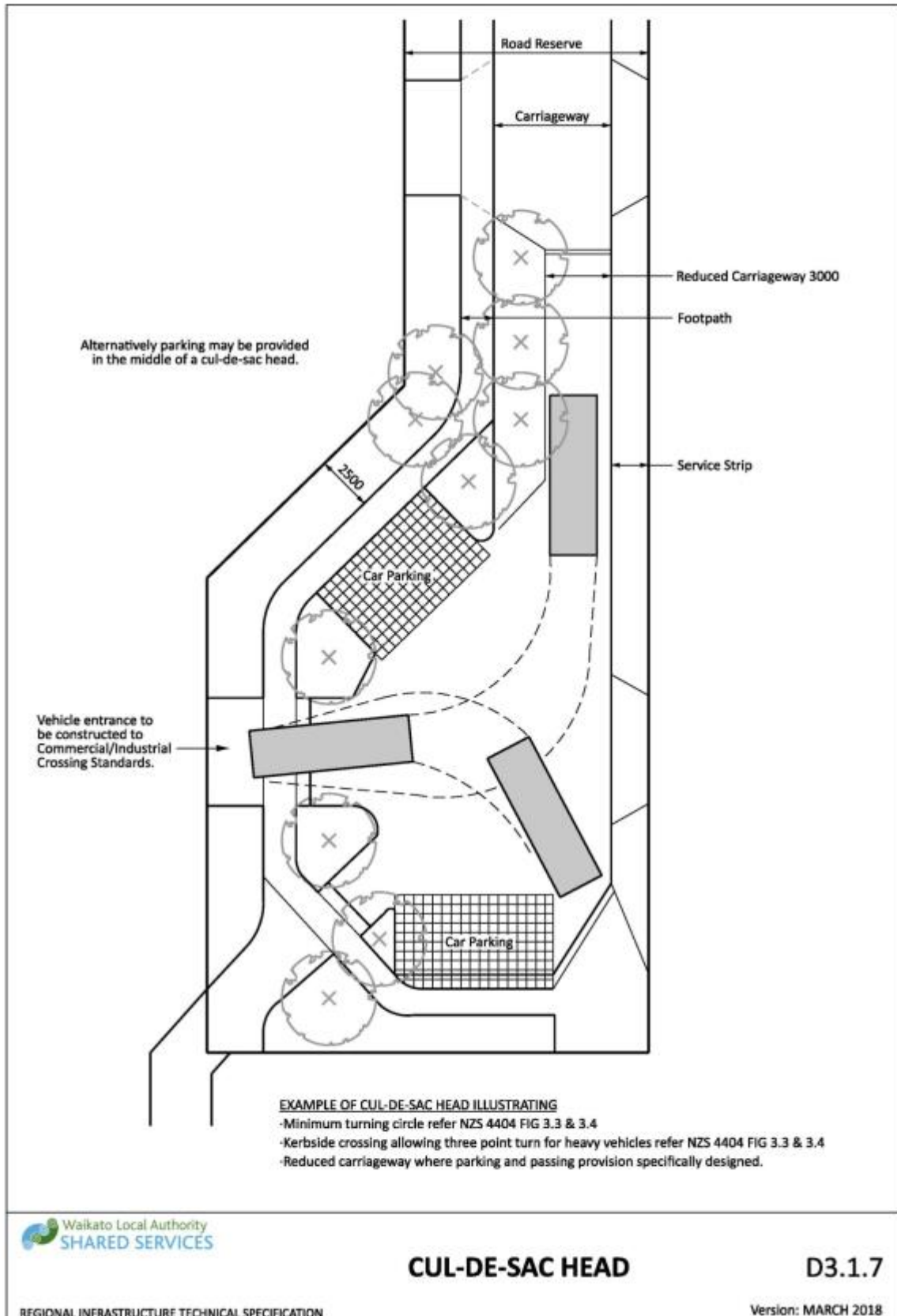

Drawing 3-8: Cul-de-sac head

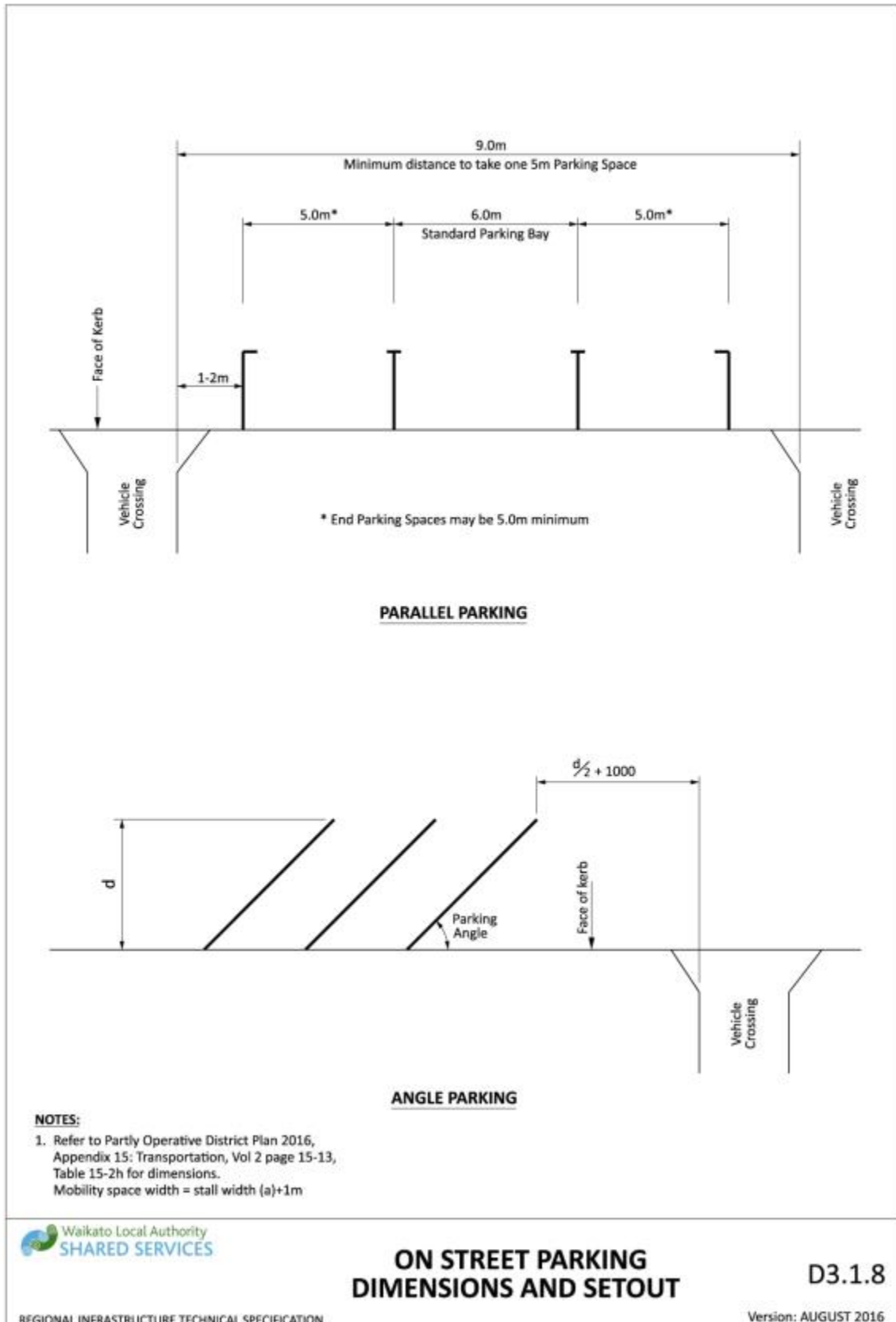

Drawing 3-9: On street parking dimensions and setout

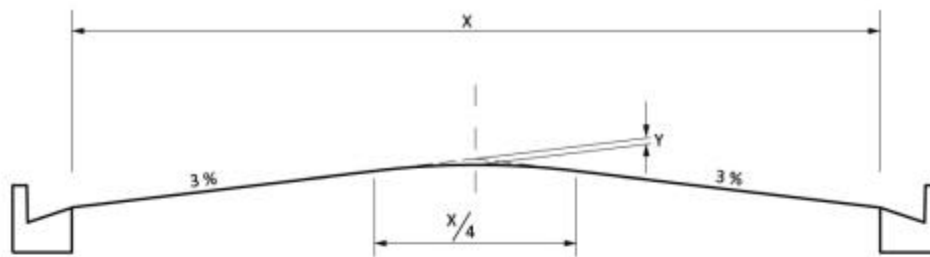

$Y \text{ (in mm)} = 2 X \text{ (where X is in metres)}$
 e.g. $X = 7.9 \text{ (8.5 carriageway)}$
 $\therefore Y = 2 \times 7.9$
 $= 16\text{mm}$

Crown Height above lip of channel (in mm) = $13X$ (where X is in metres)

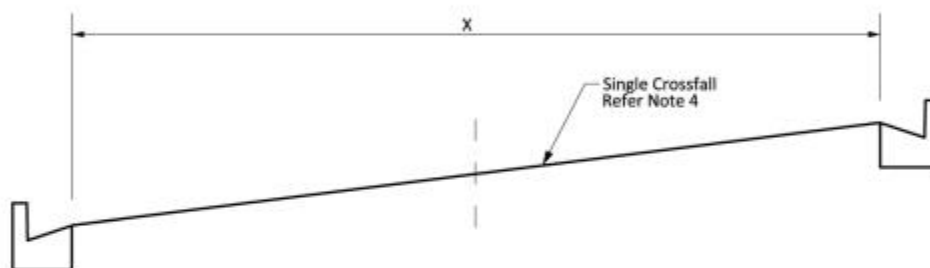

TABLE OF LEVEL TOLERANCES FOR FLEXIBLE PAVEMENTS

At top of Layer	Centreline and near Pavement edge	At Channel edge	Deviation from 3m straight edge or camber board
Surface			1: 12mm 2: 8mm
Basecourse	-5mm to +15mm	1: 0mm to +10mm 2: -5mm to +5mm	12mm
Sub-base	-25mm to +5mm	-25mm to +5mm	15mm
Subgrade	-30mm to 0mm	-30mm to 0mm	15mm

NOTES:

1. Chip sealed surface
2. Asphalt surface (minimum 25mm thick)
3. Construction levels are based on lip of channel, appropriate crossfall and designed pavement layer thickness
4. Single crossfall may be permitted in certain circumstances, eg super-elevation or private entrance.



NORMAL CARRIAGEWAY CAMBER AND CONSTRUCTION TOLERANCES

D3.2.1

REGIONAL INFRASTRUCTURE TECHNICAL SPECIFICATION

Version: AUGUST 2016

Drawing 3-10: Normal carriageway camber and construction tolerances

NOTES:

1. C.B.R. values obtained from the ground are not applicable where material contains aggregate greater than 10mm in size.
2. Penetration readings are valid after 75mm of penetration into firm material being tested.
3. To use graph below, count number of blows for each 100mm (10cm) approx. of penetration and divide by number of drops. This gives Penetration (cm per blow).
4. Graphs show C.B.R. (California Bearing Ratio) equivalent values on Hamilton Sand Silt materials.
5. Plot is based on research work undertaken by J.F. Briggs, Senior Engineer, M.W.D., Hamilton.

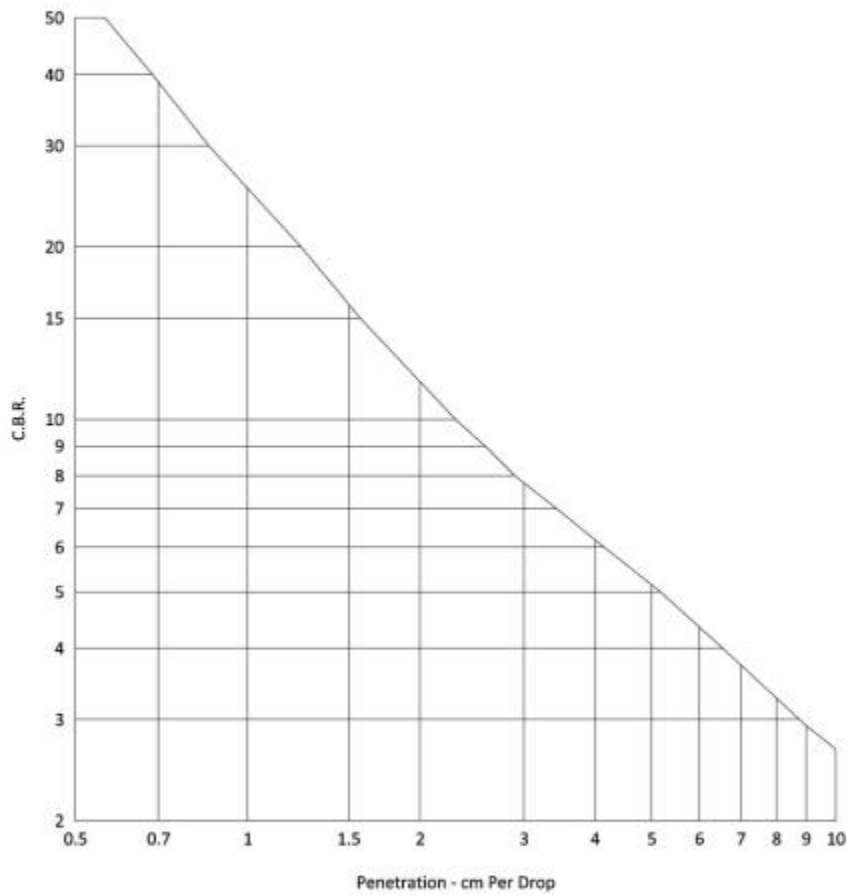

SCALA PENETROMETER (9kg Hammer)



C.B.R. v PENETRATION GRAPHS FOR HAMILTON SAND SILT MATERIALS

D3.2.2

REGIONAL INFRASTRUCTURE TECHNICAL SPECIFICATION

Version: AUGUST 2016

Drawing 3-11: C.B.R v penetration graphs for Hamilton sand silt materials

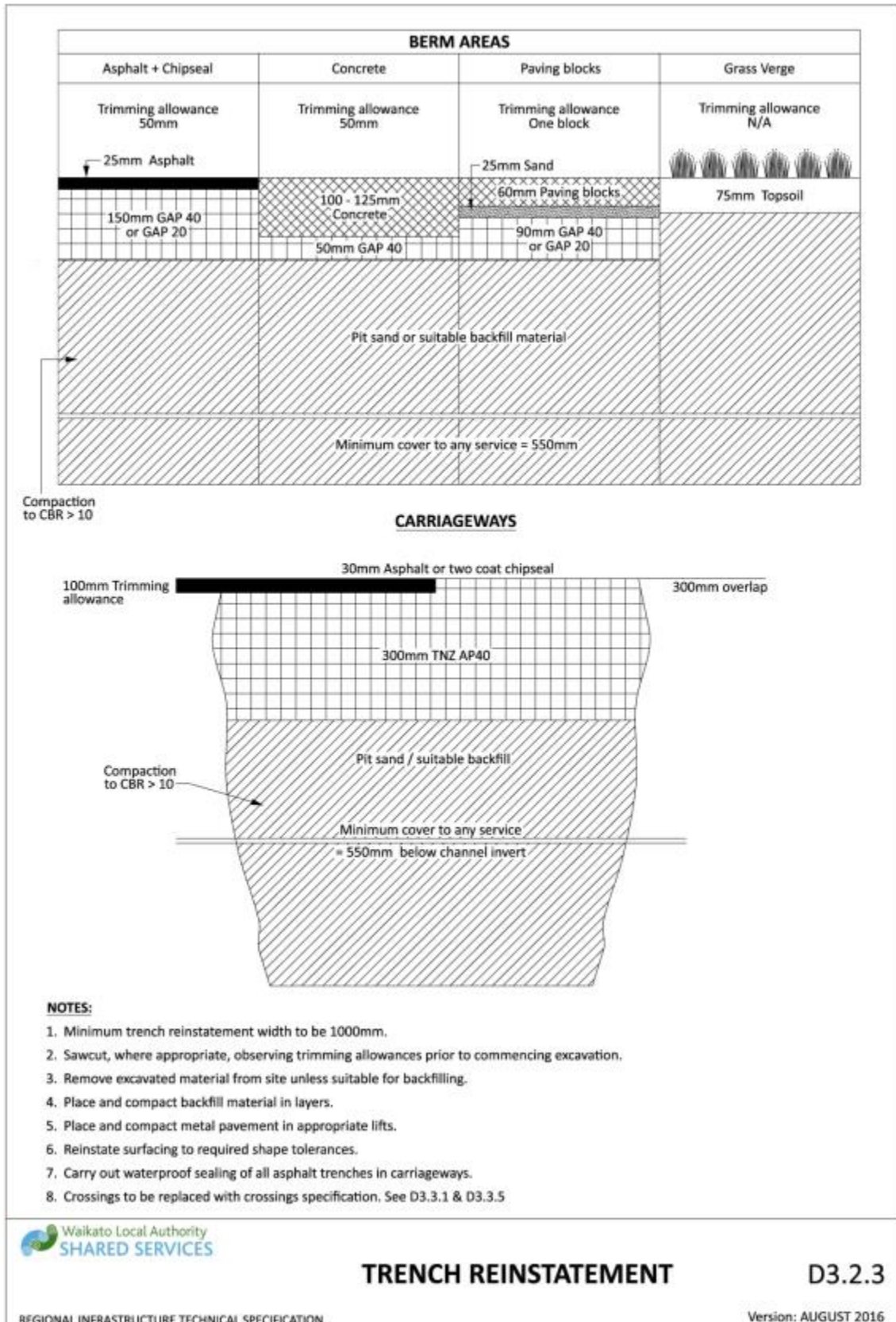

Drawing 3-12: Trench reinstatement

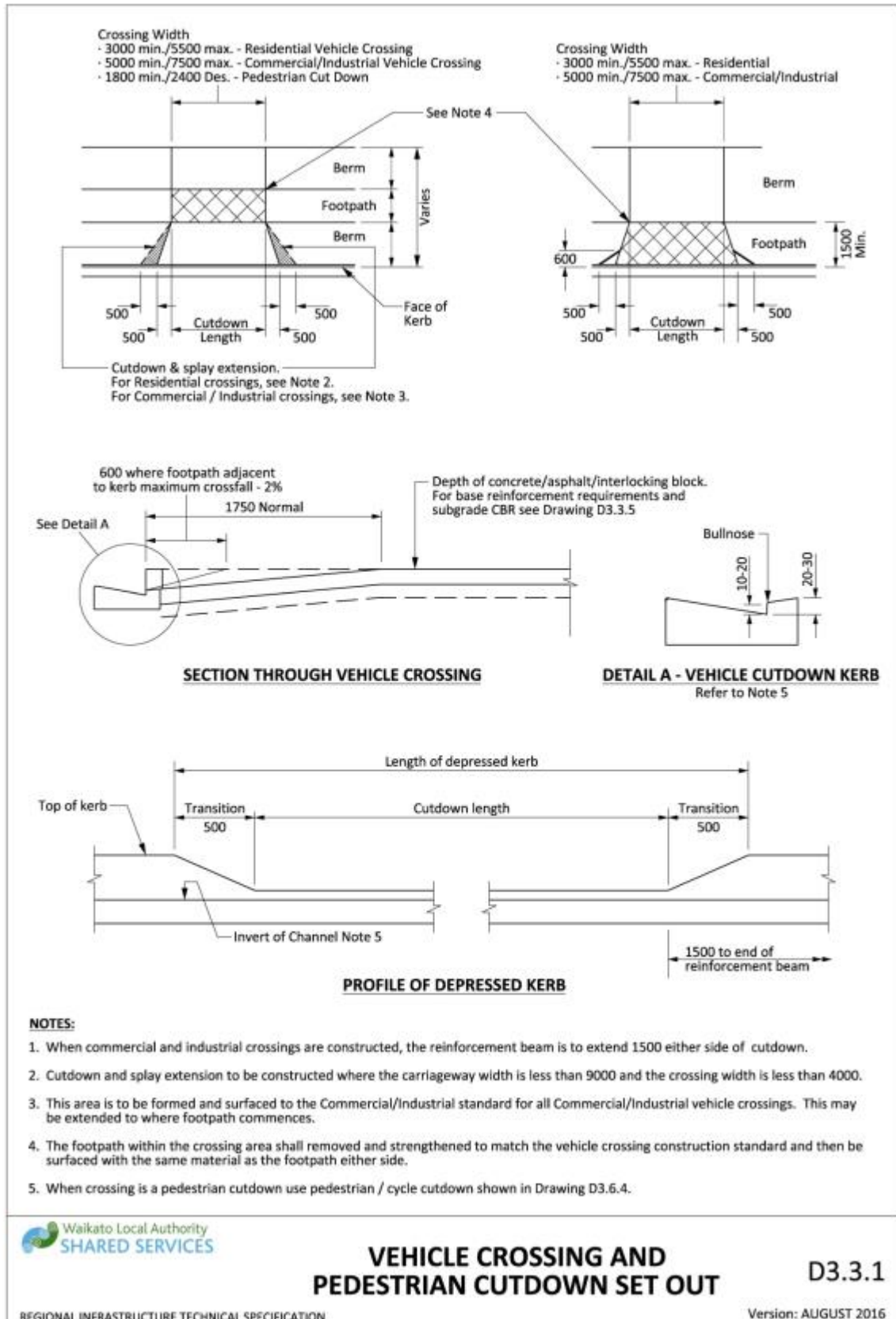

Drawing 3-13: Vehicle crossing and pedestrian cutdown set out

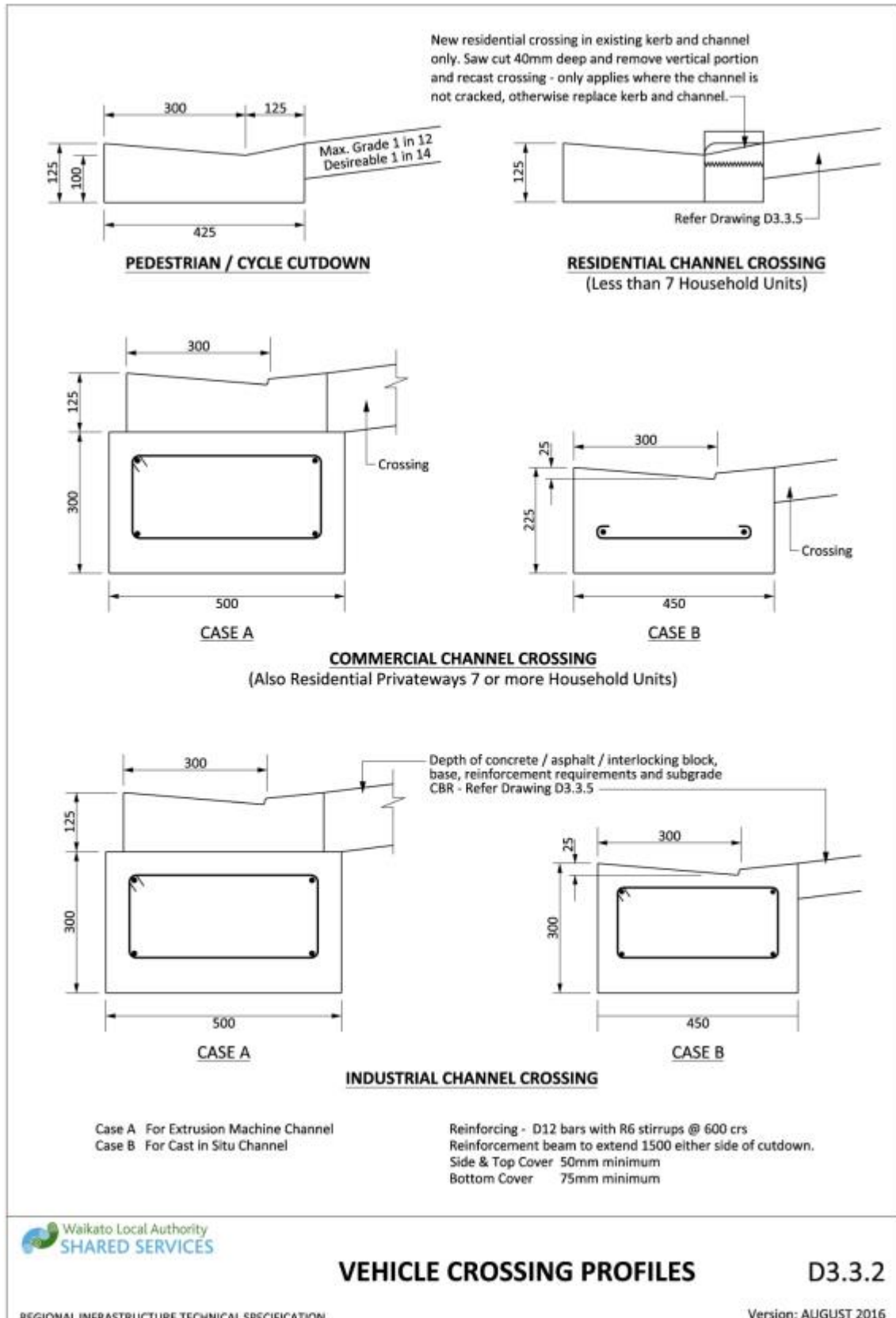

Drawing 3-14: Vehicle crossing profiles

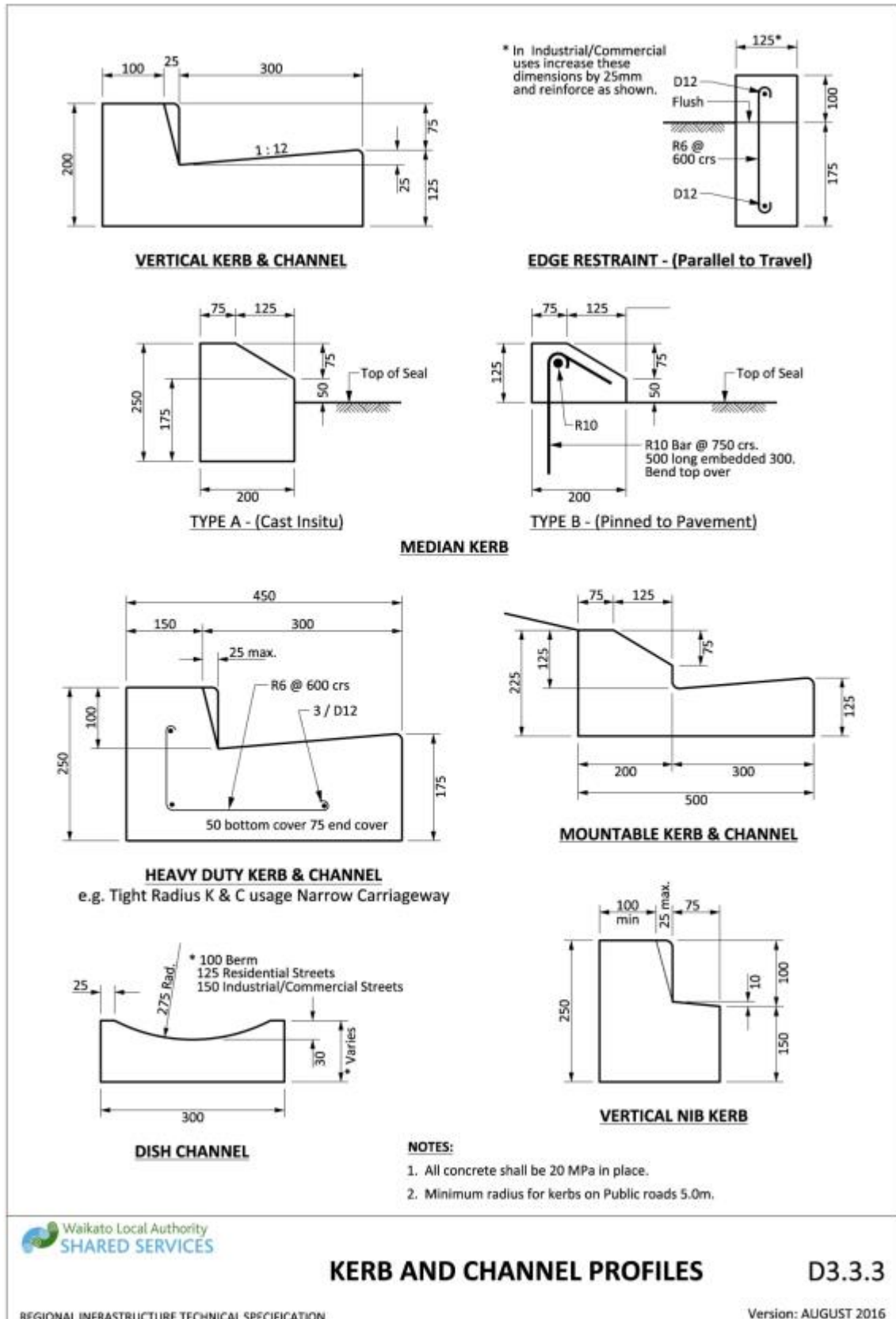

Drawing 3-15: Kerb and channel profiles

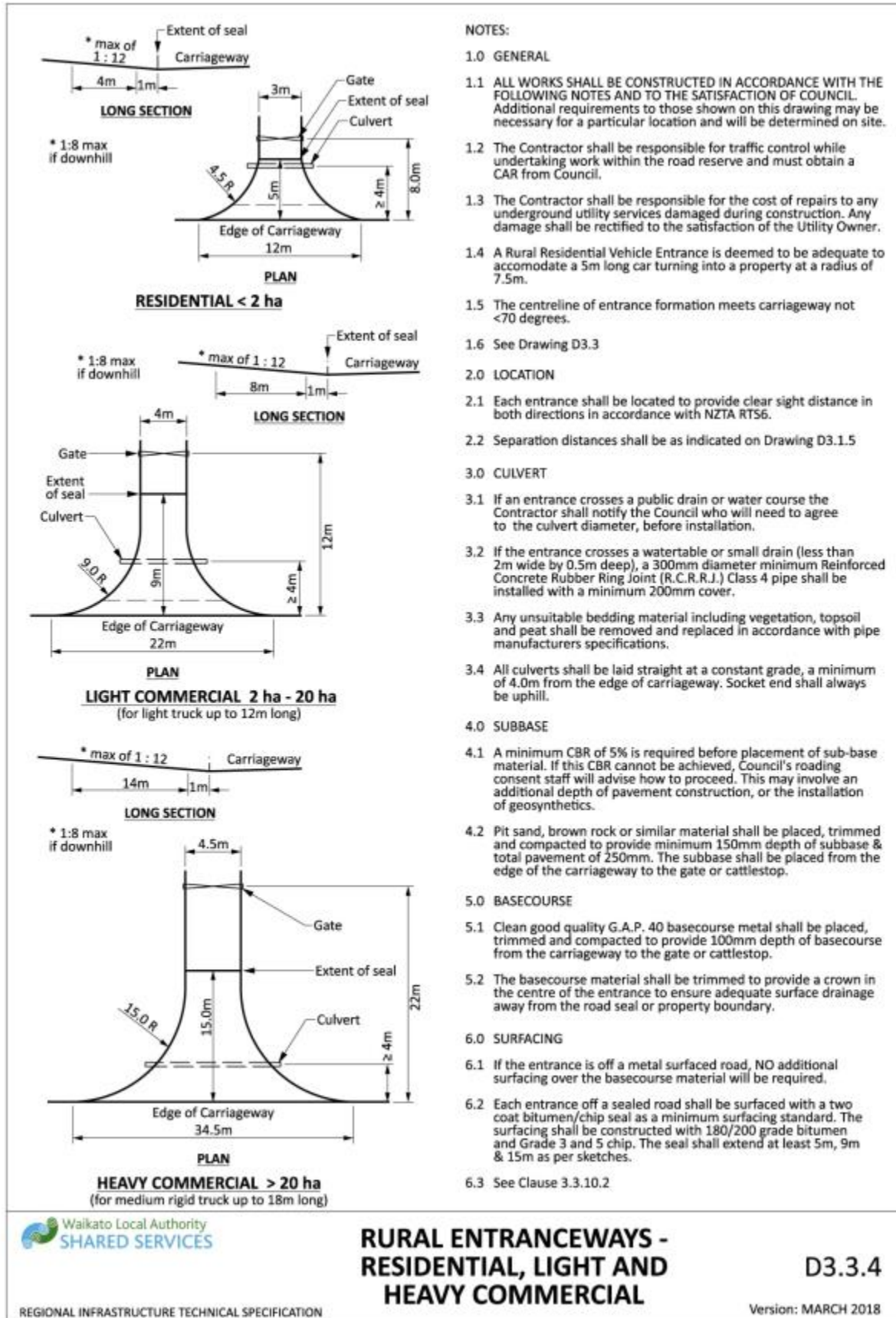

Drawing 3-16: Rural entranceways - residential, light and heavy commercial

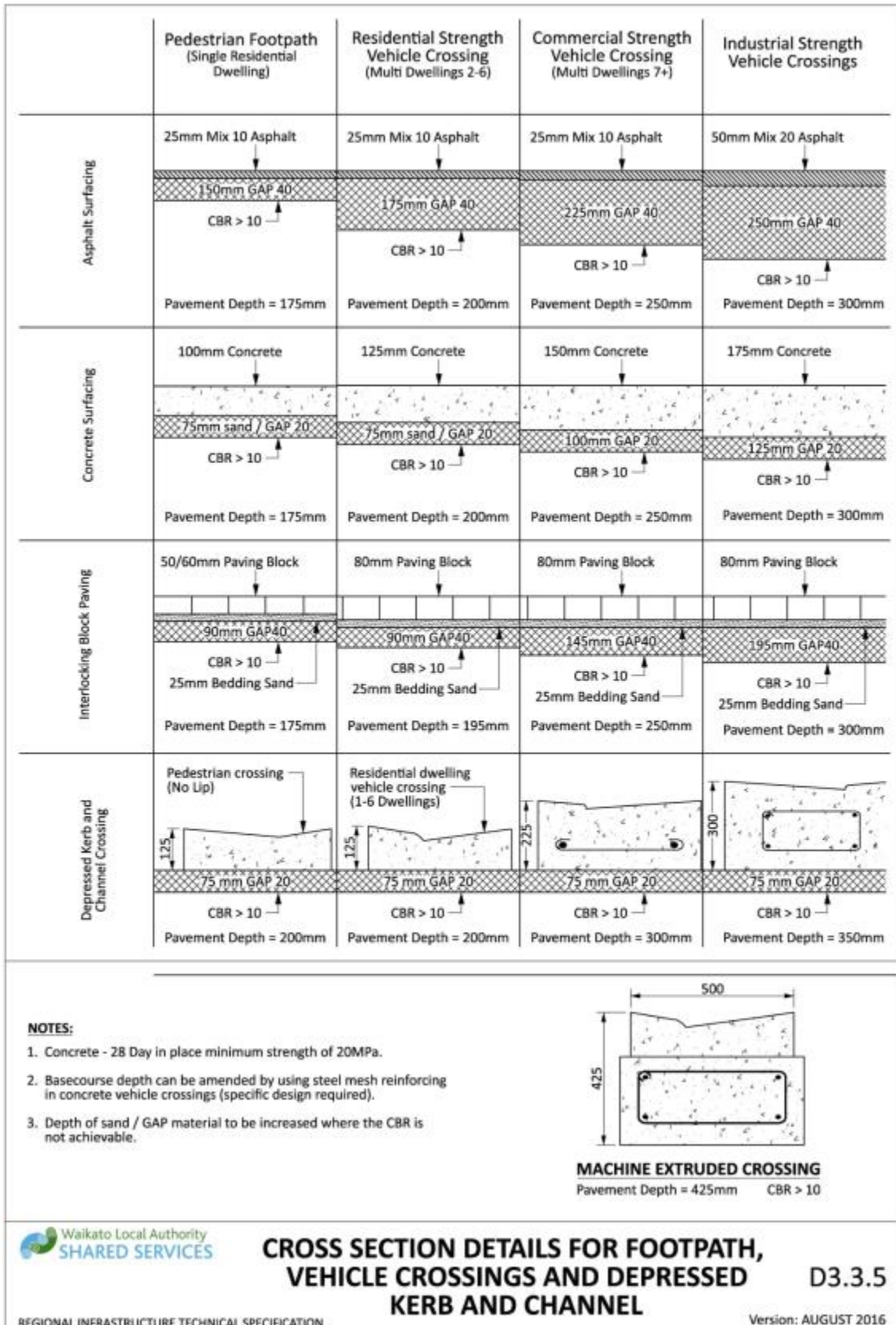

Drawing 3-17: Cross section details for footpath, vehicle crossings and depressed kerb and channel

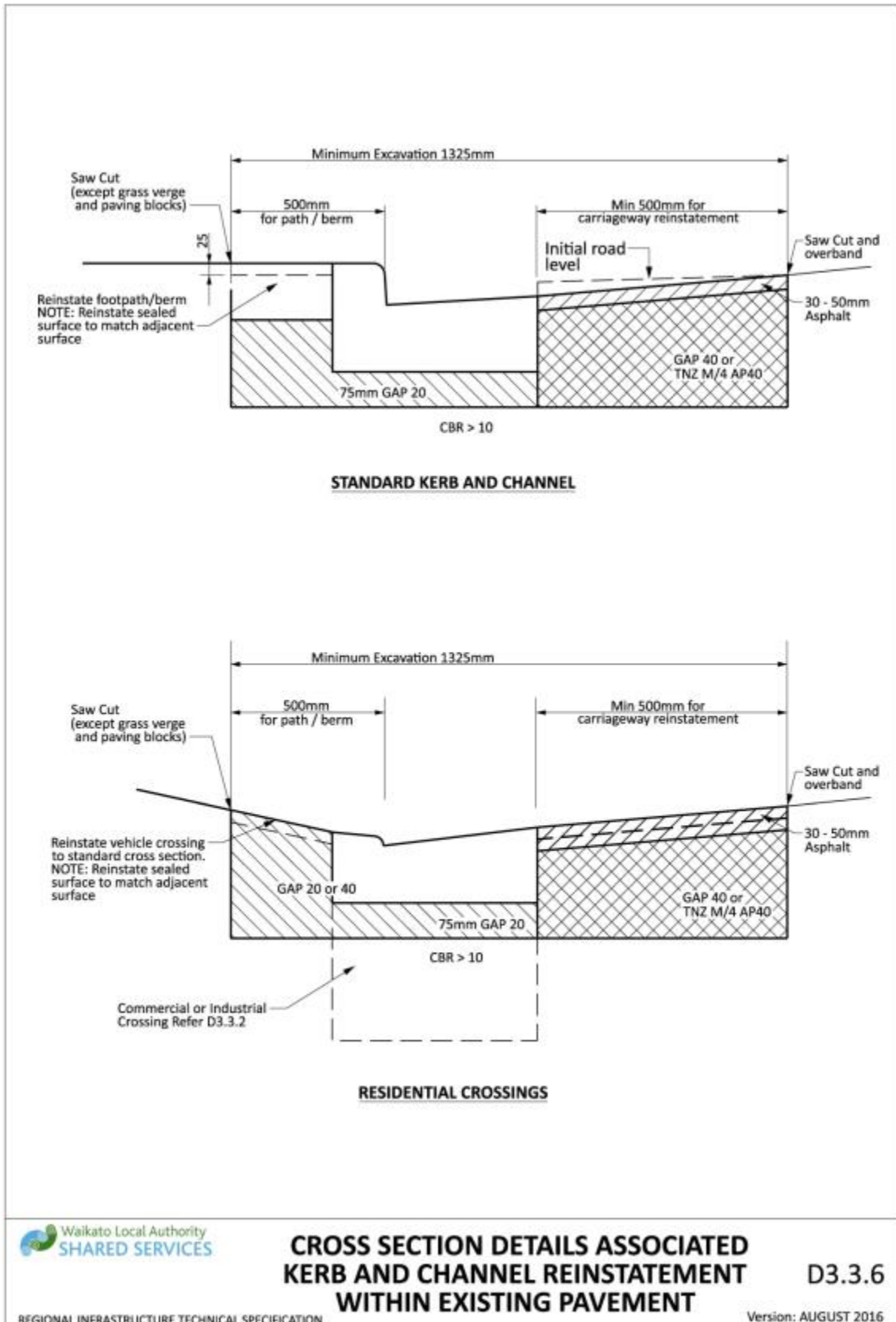

Drawing 3-18: Cross section details associated kerb and channel reinstatement within existing pavement

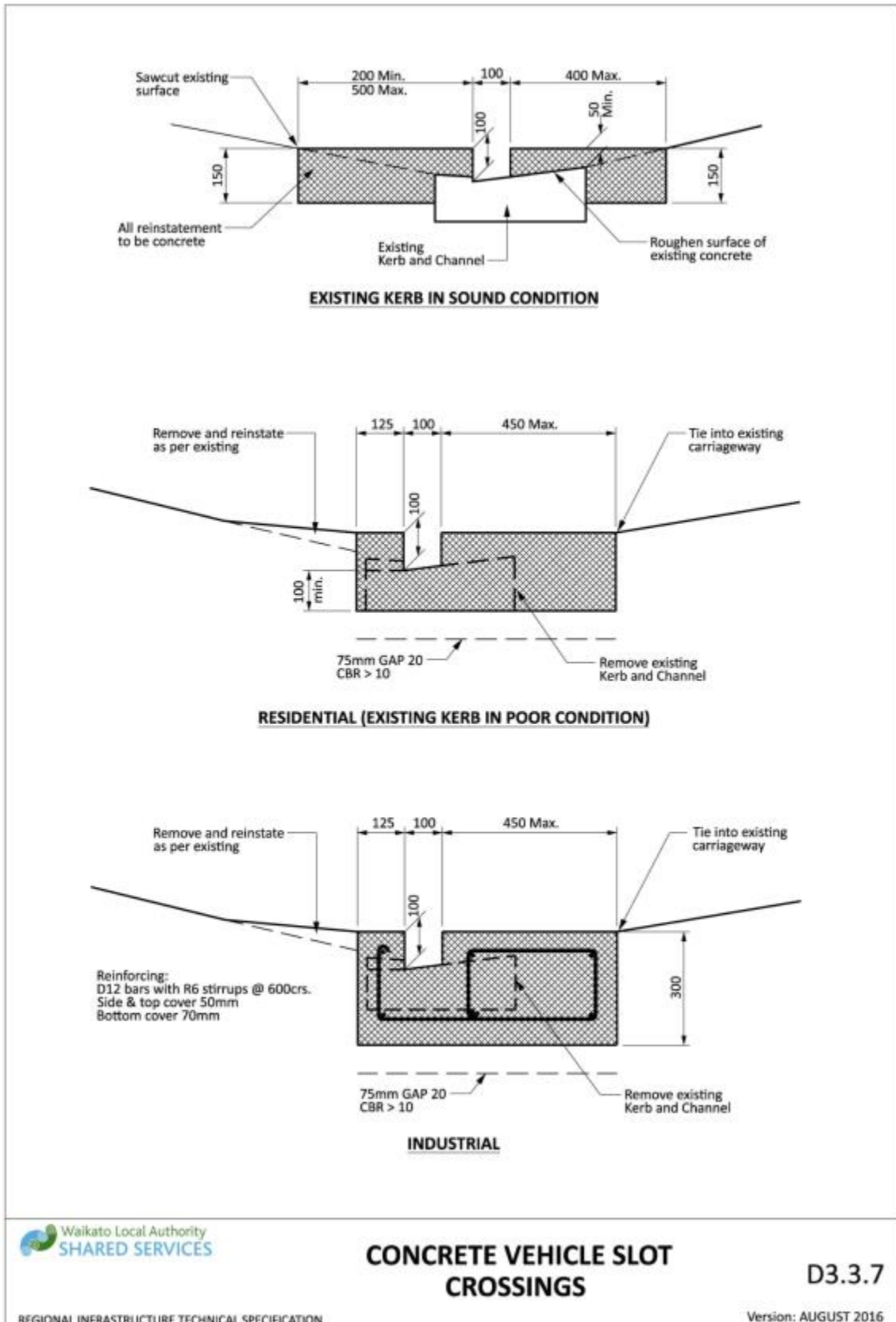

Drawing 3-19: Concrete vehicle slot crossings

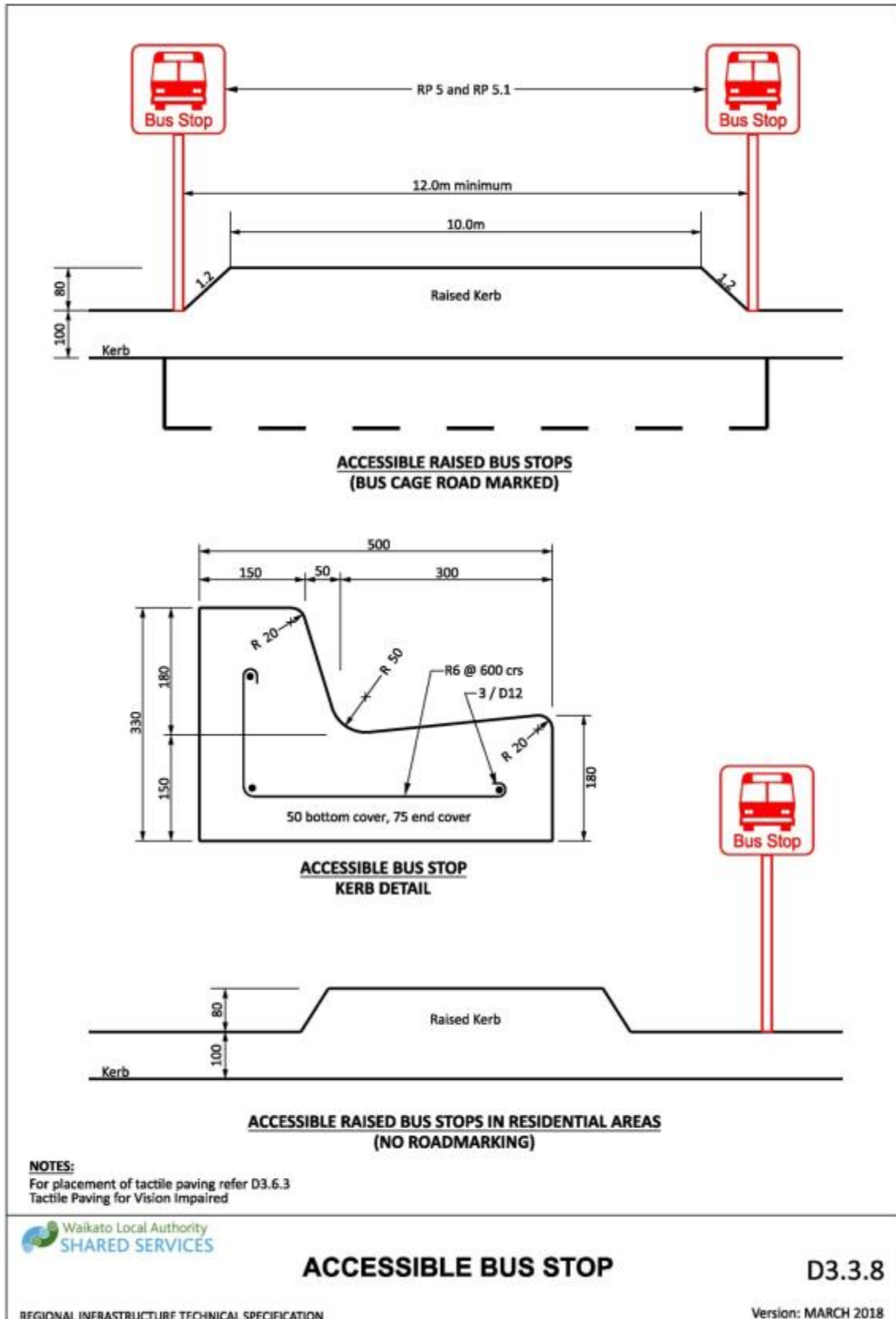

Drawing 3-20: Accessible bus stop

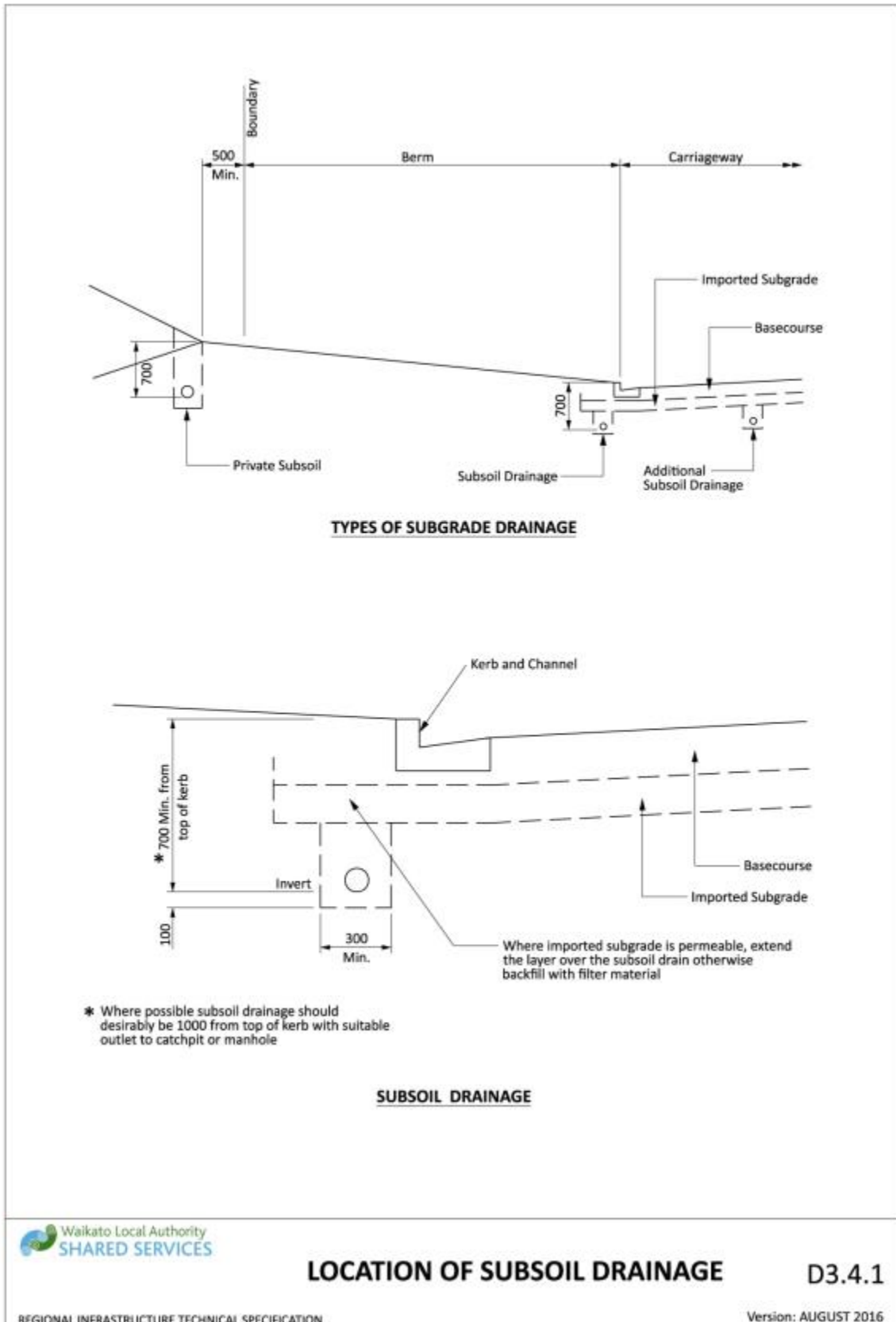

Drawing 3-21: Location of subsoil drainage

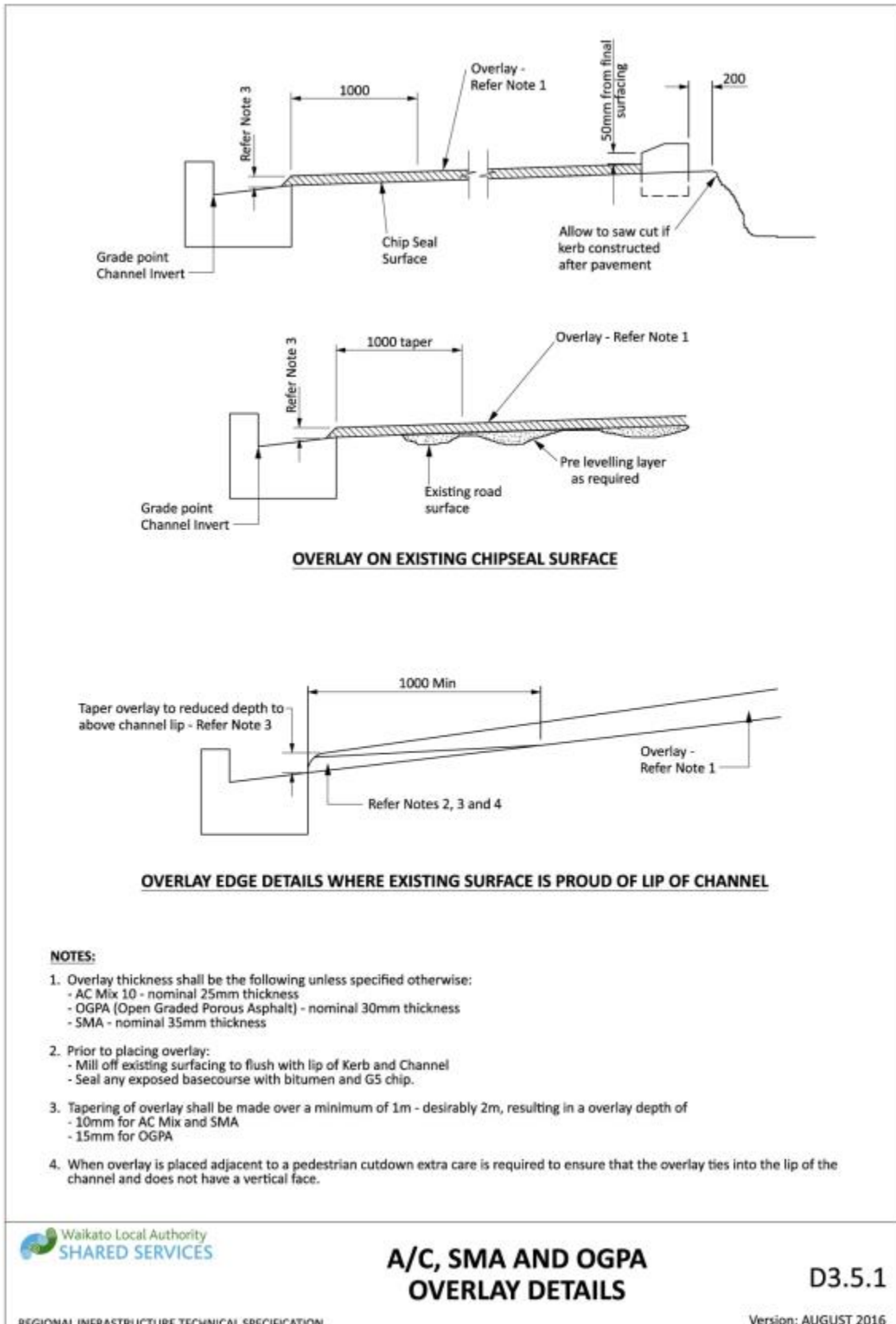

Drawing 3-22: A/C, SMA and OGPA overlay details

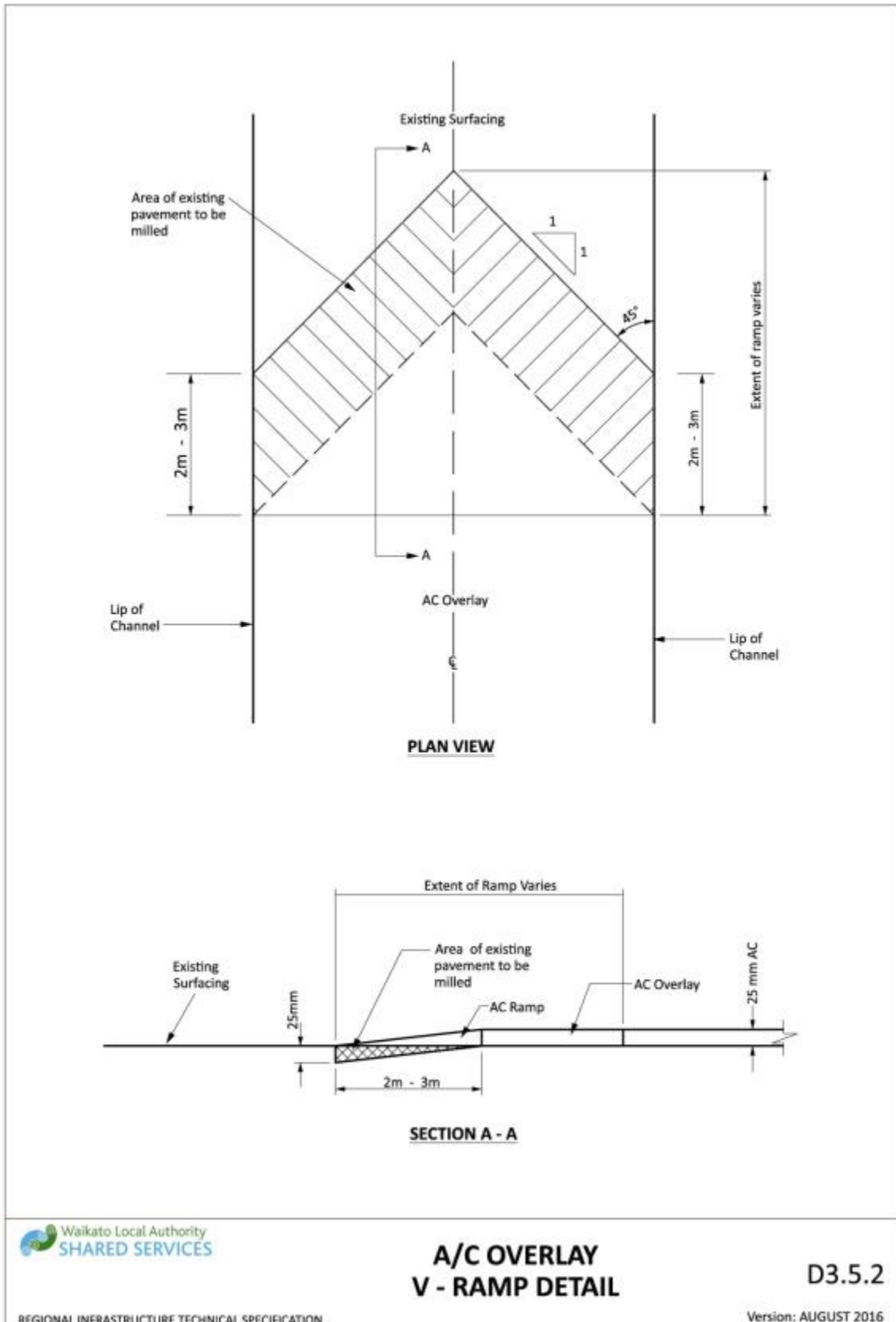

Drawing 3-23: A/C overlay v-ramp detail

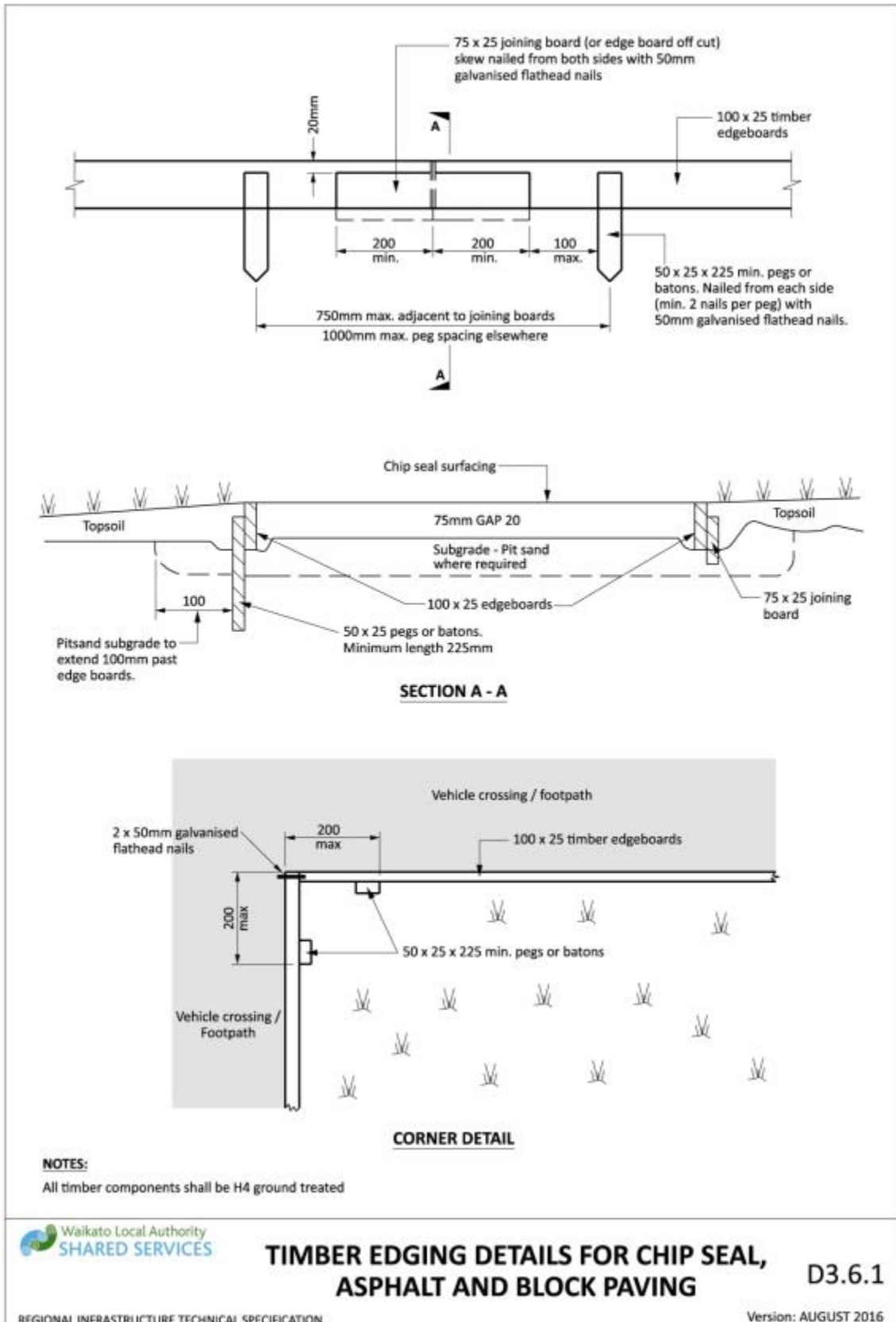

Drawing 3-24: Timber edging details for chip seal, asphalt and block paving

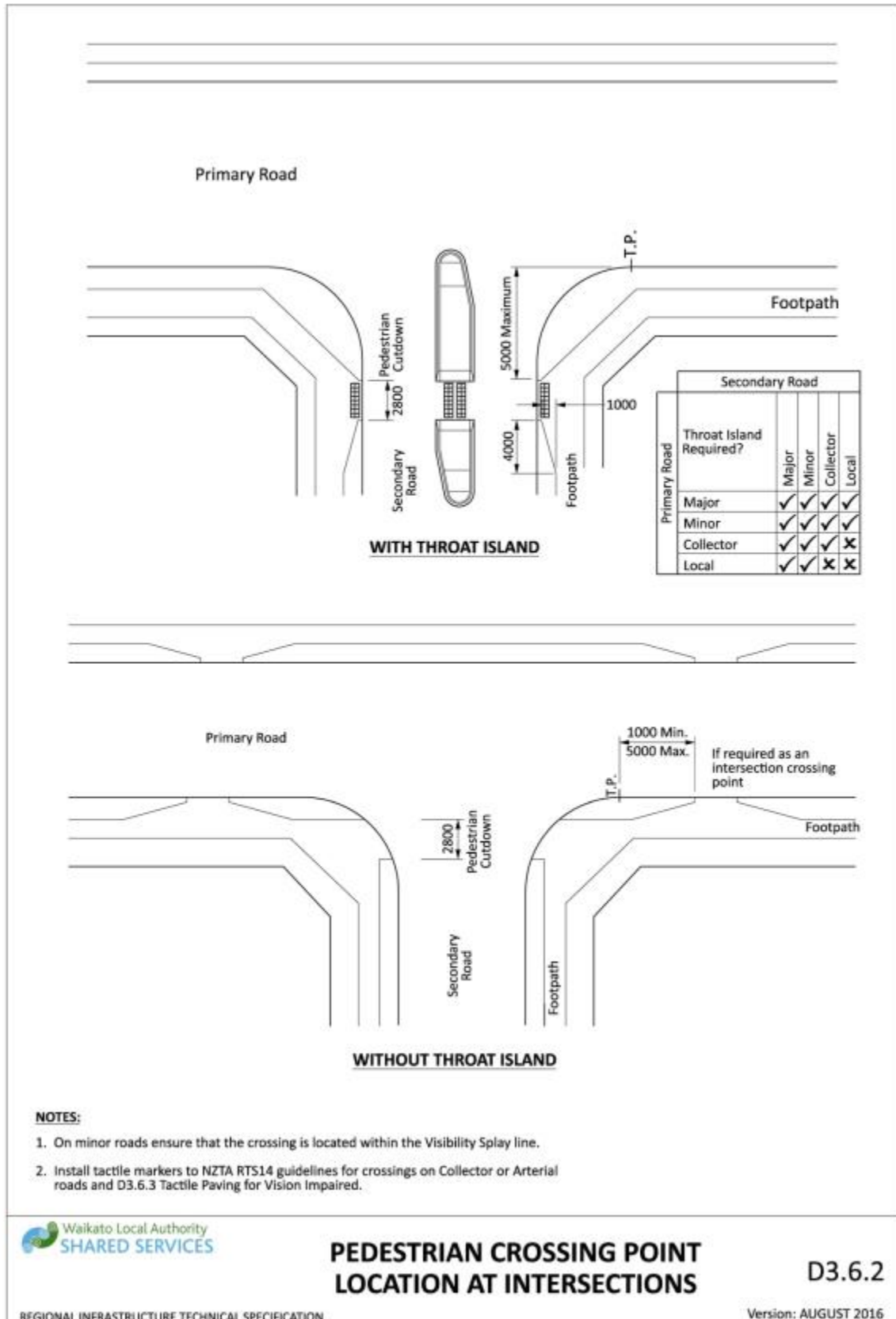

Drawing 3-25: Pedestrian crossing point location at intersections

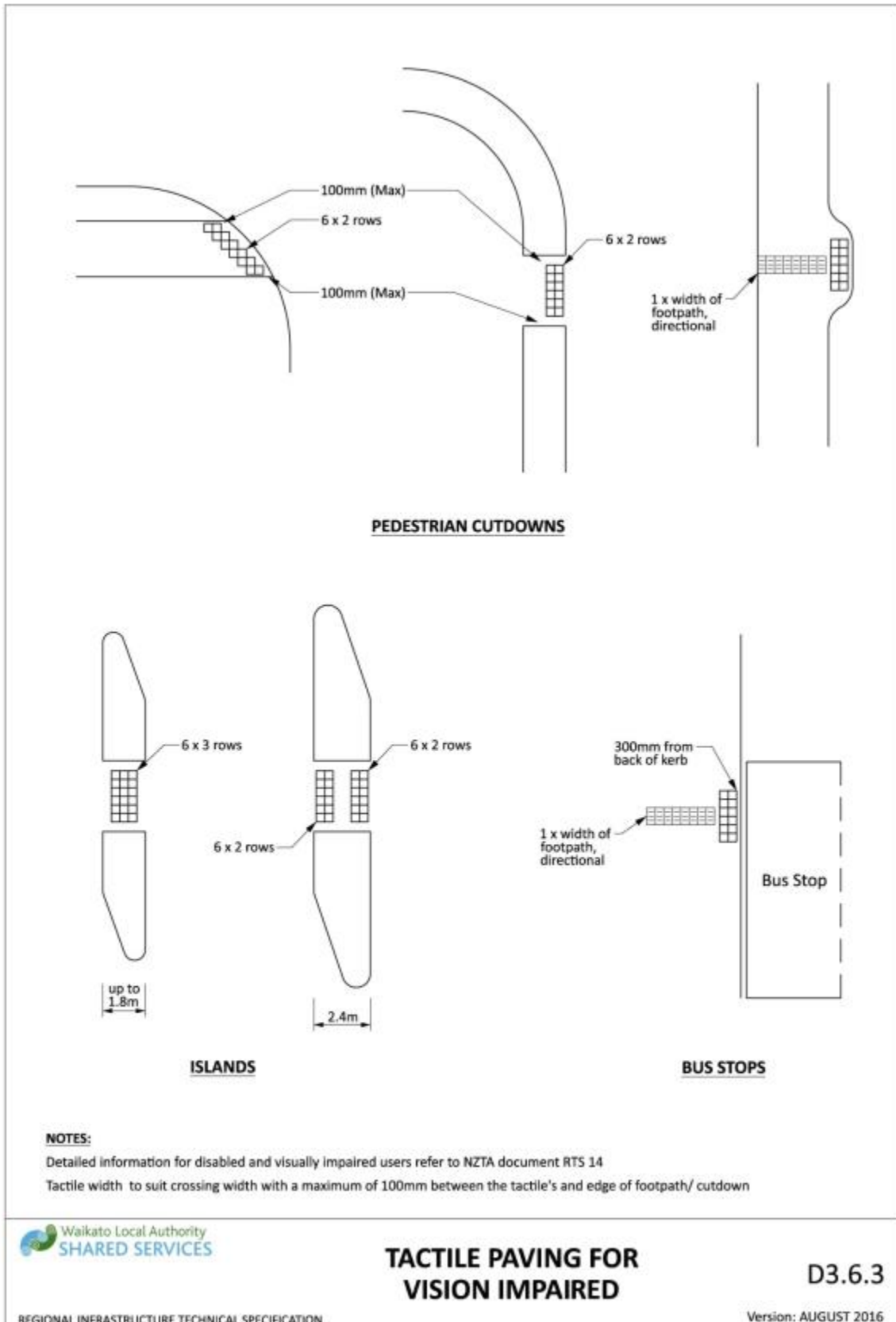

Drawing 3-26: Tactile paving for vision impaired

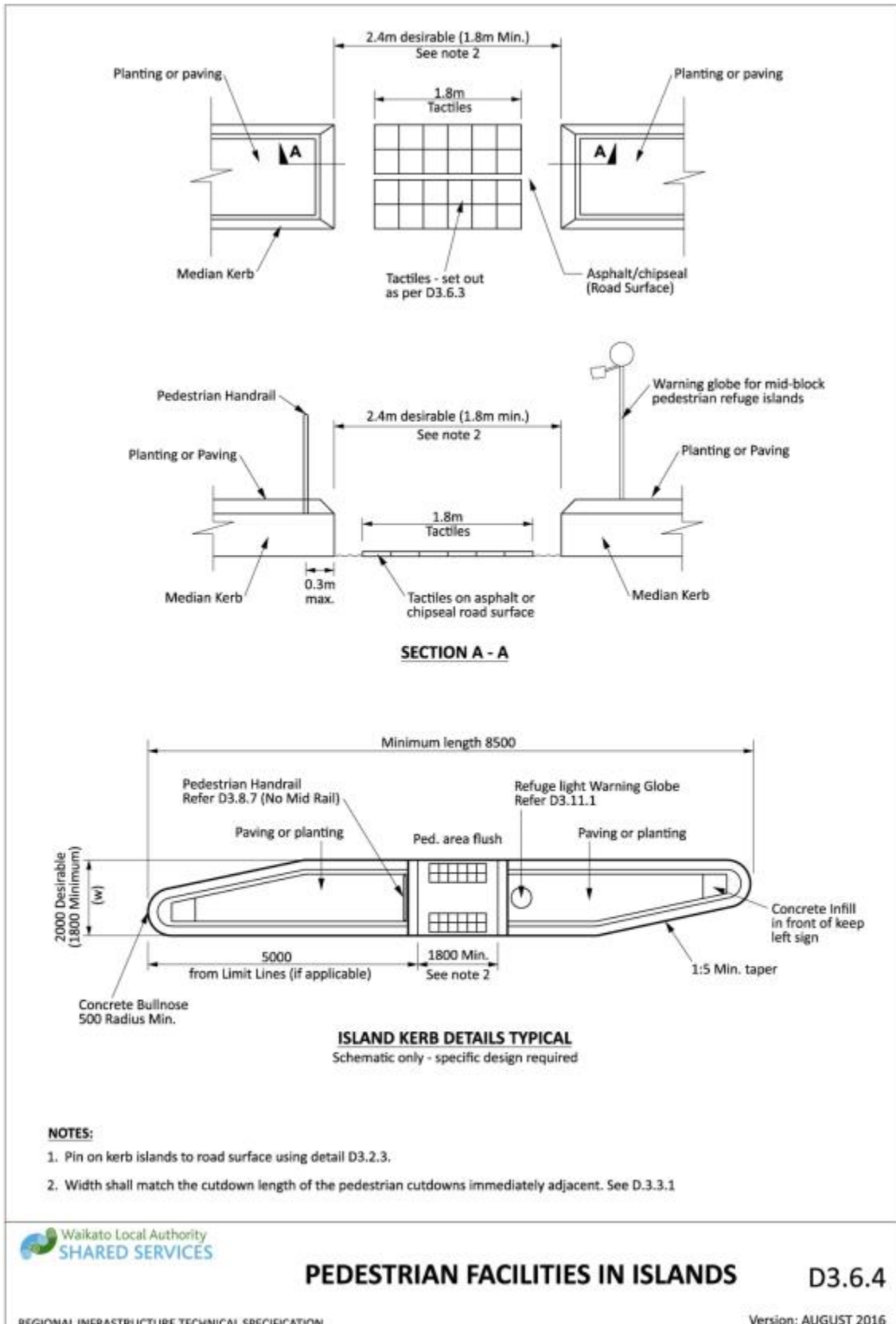

Drawing 3-27: Pedestrian facilities in islands

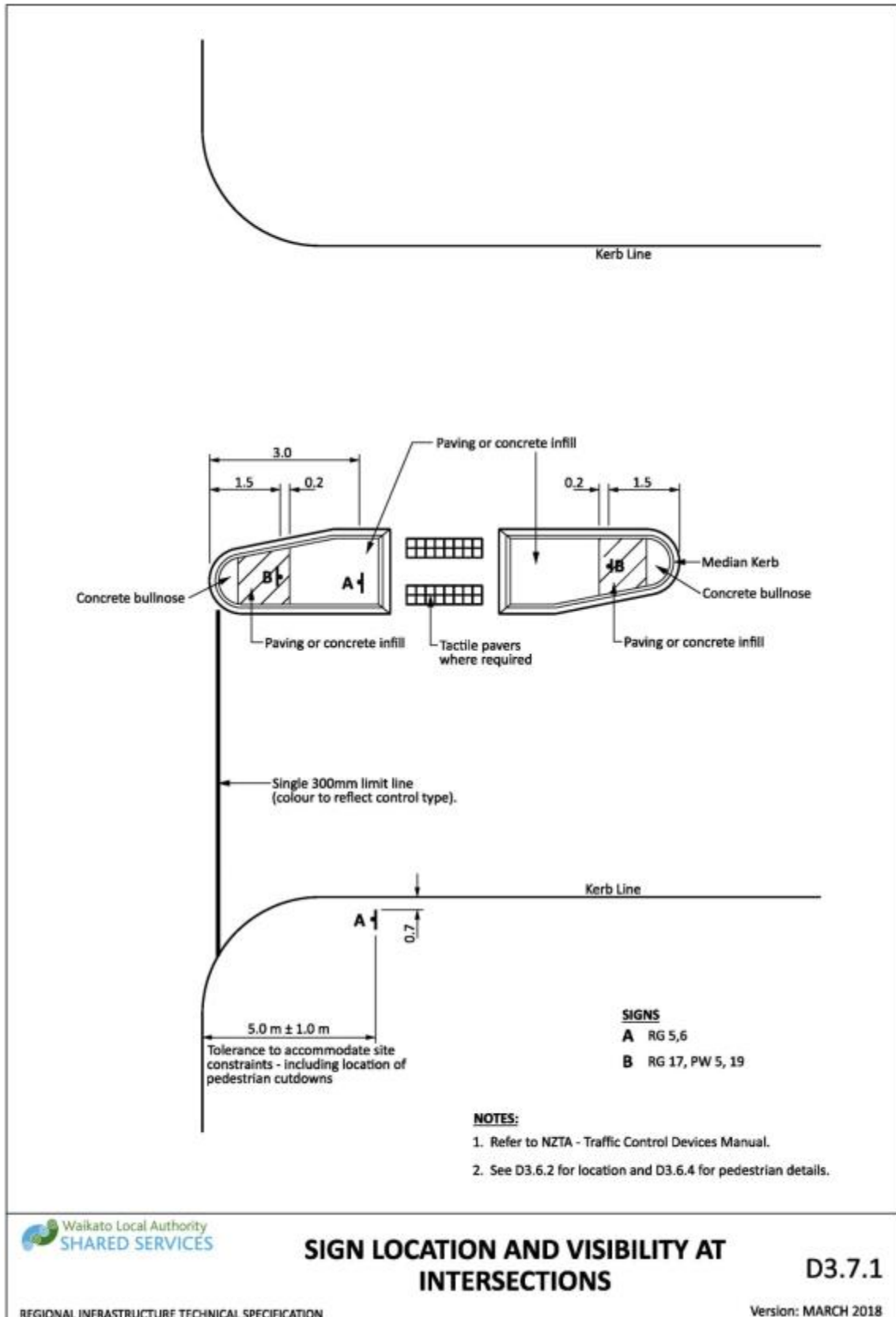

Drawing 3-28: Sign location and visibility at intersections

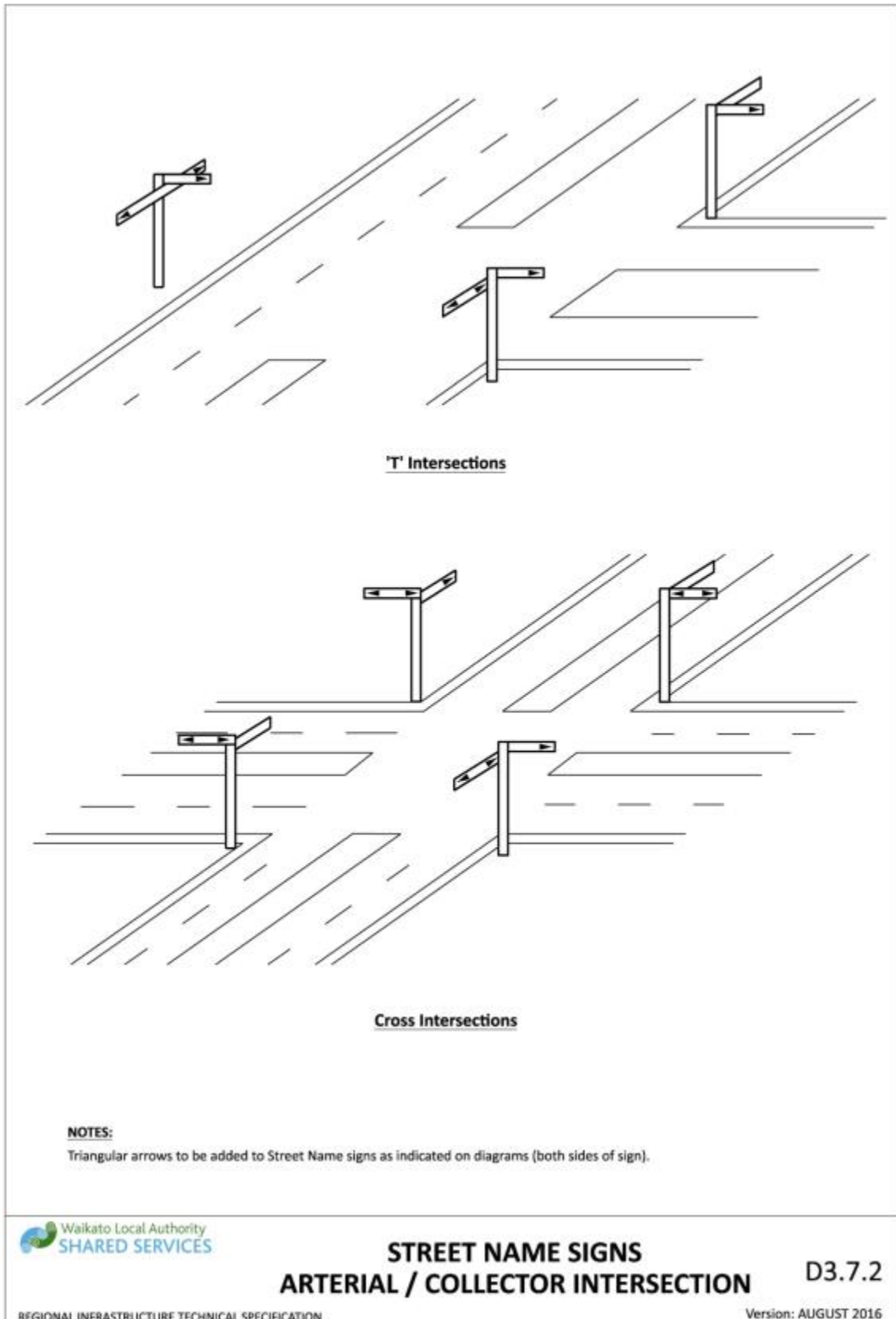

Drawing 3-29: Street name signs arterial/collector intersection

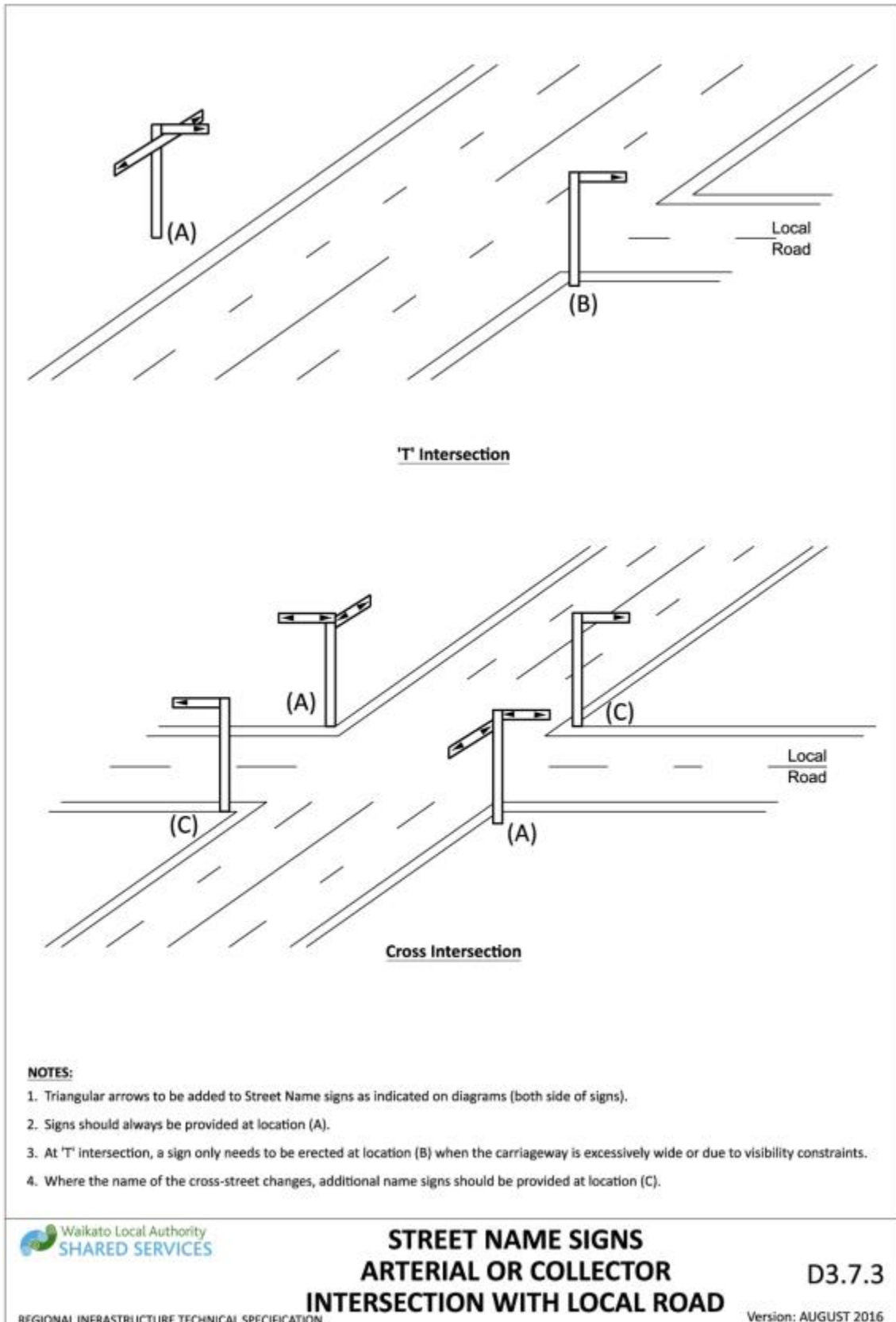

Drawing 3-30: Street name signs - arterial or collector intersection with local road

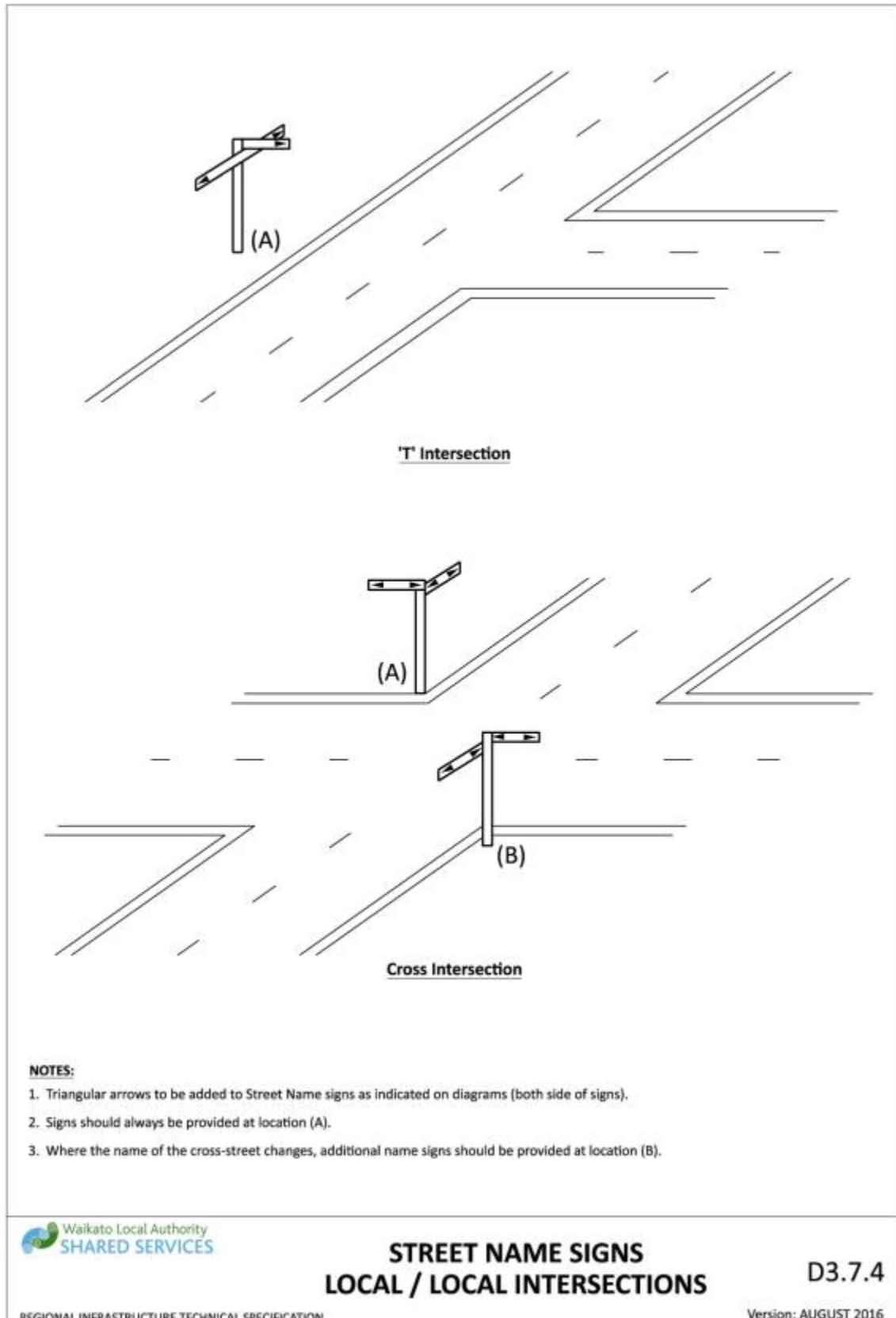

Drawing 3-31: Street name signs local/local intersection

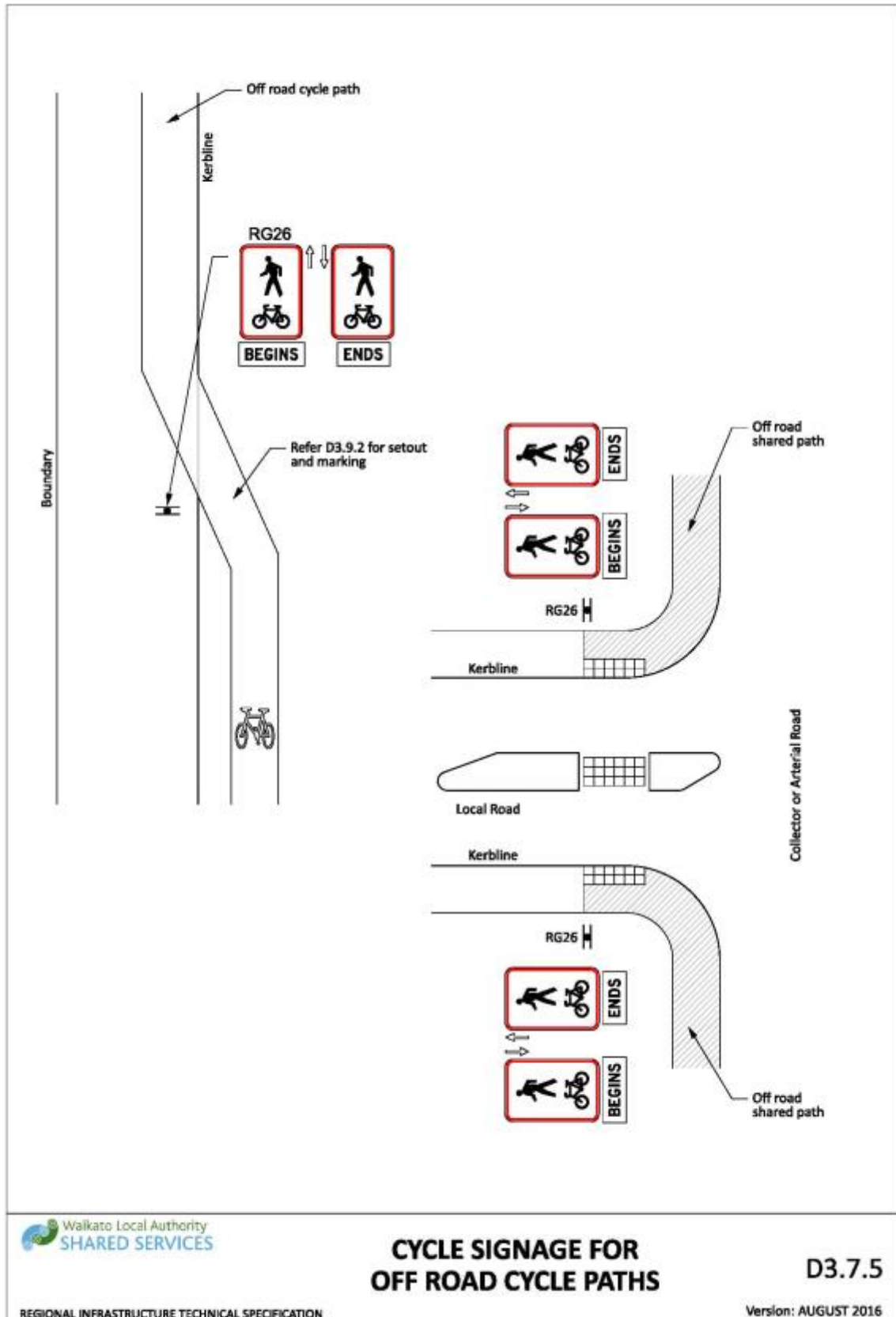

Drawing 3-32: Cycle signage for off road cycle paths

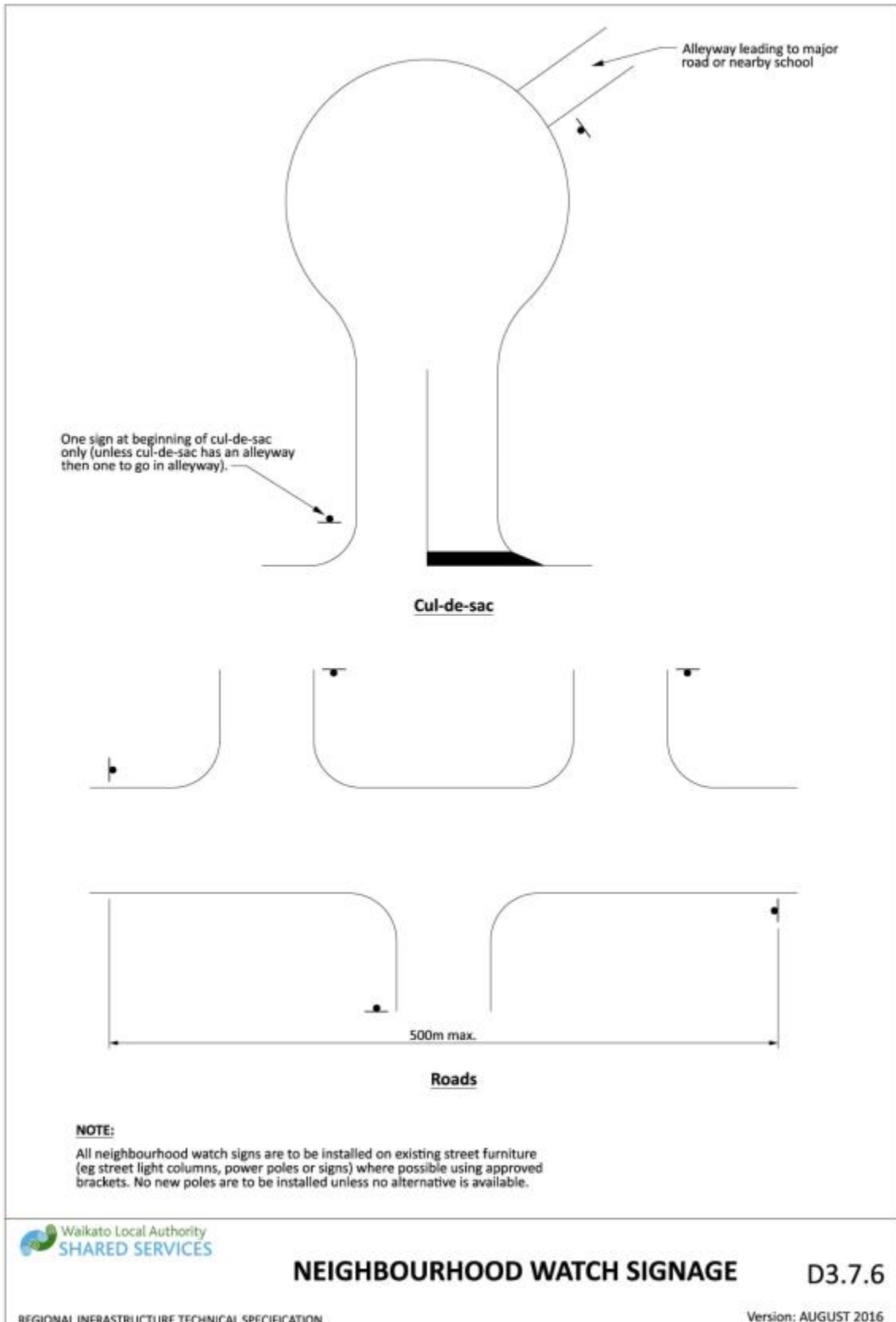

Drawing 3-33: Neighbourhood watch signage

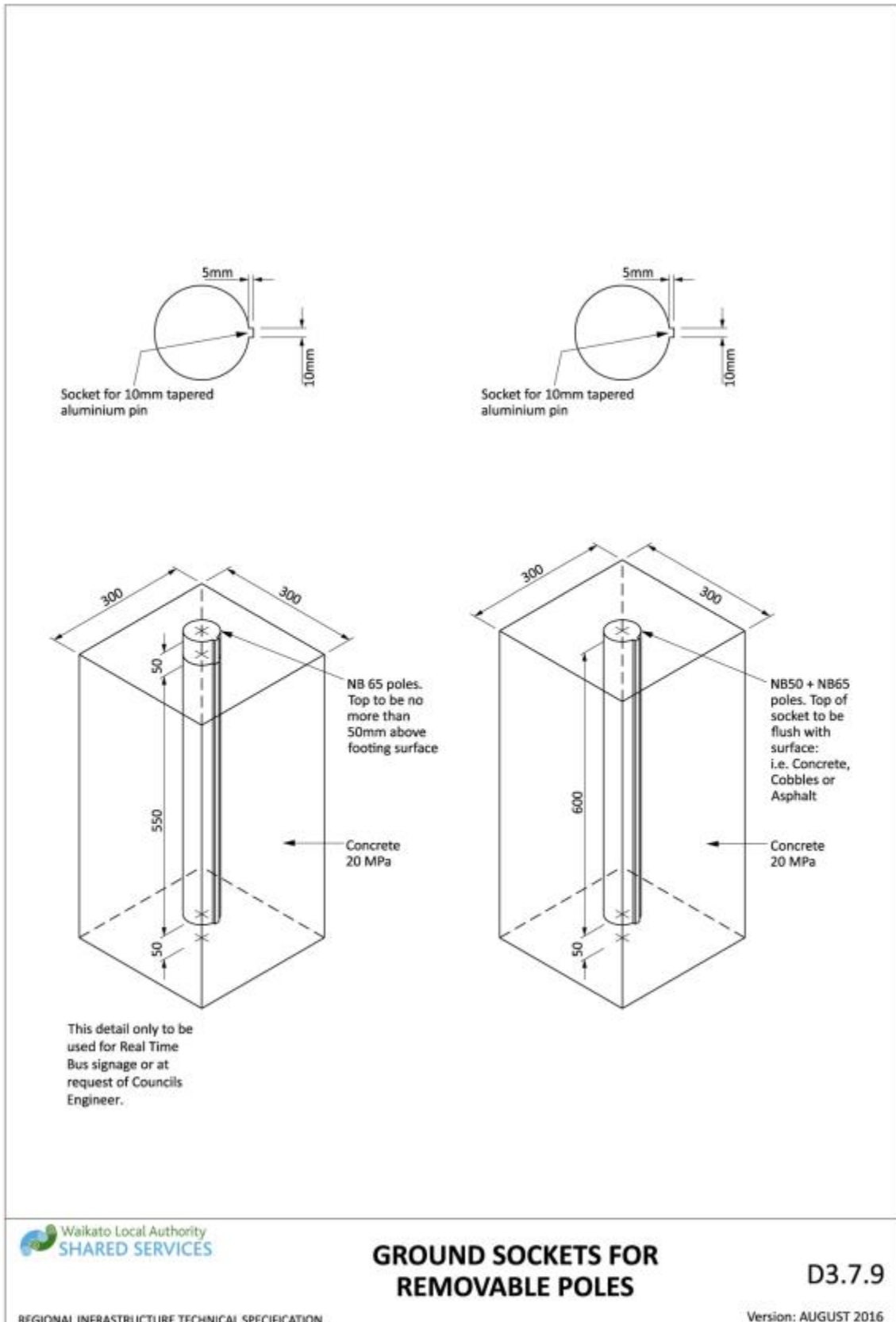

Drawing 3-34: Ground sockets for removable poles

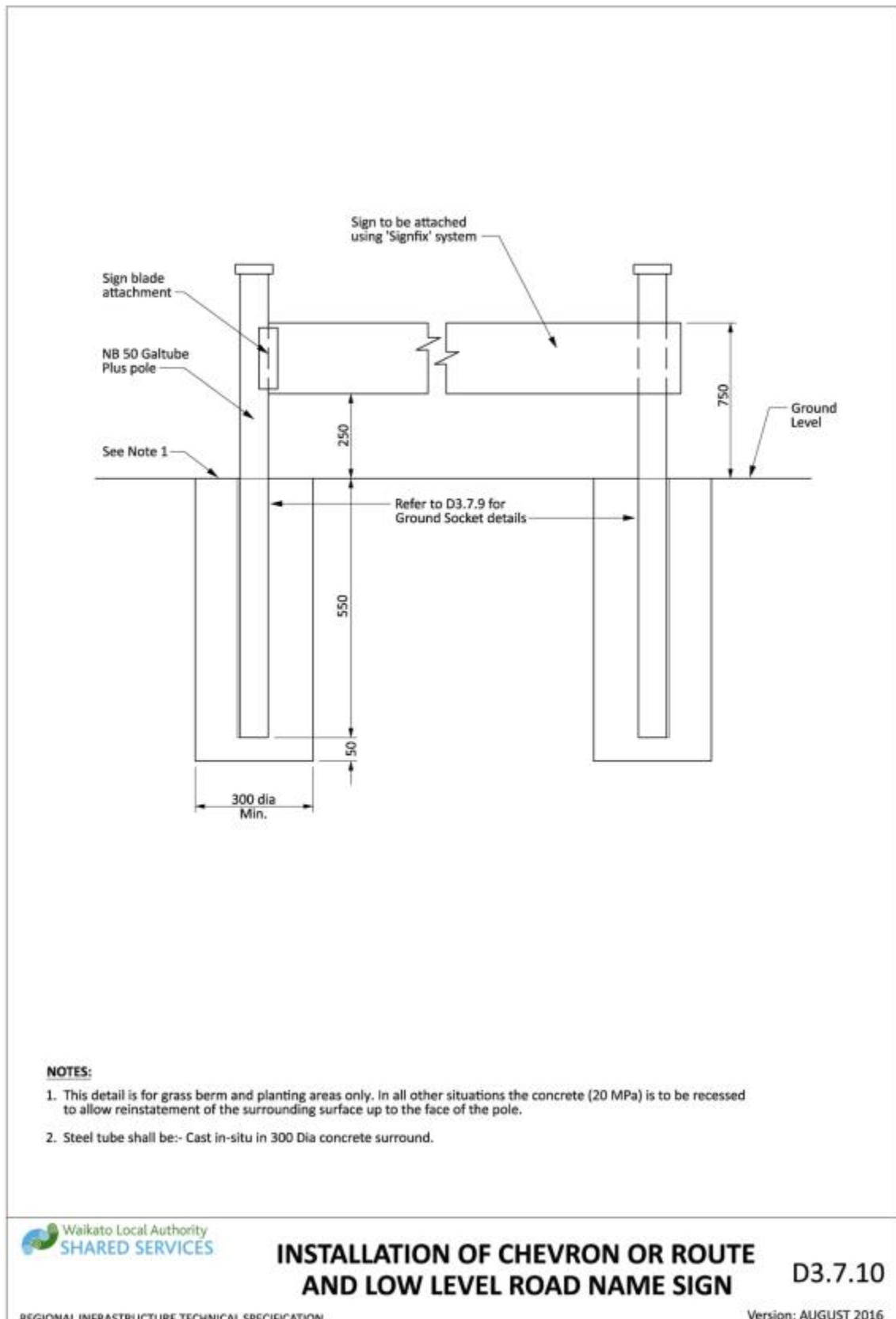

Drawing 3-35: Installation of chevron or route and low level road name sign

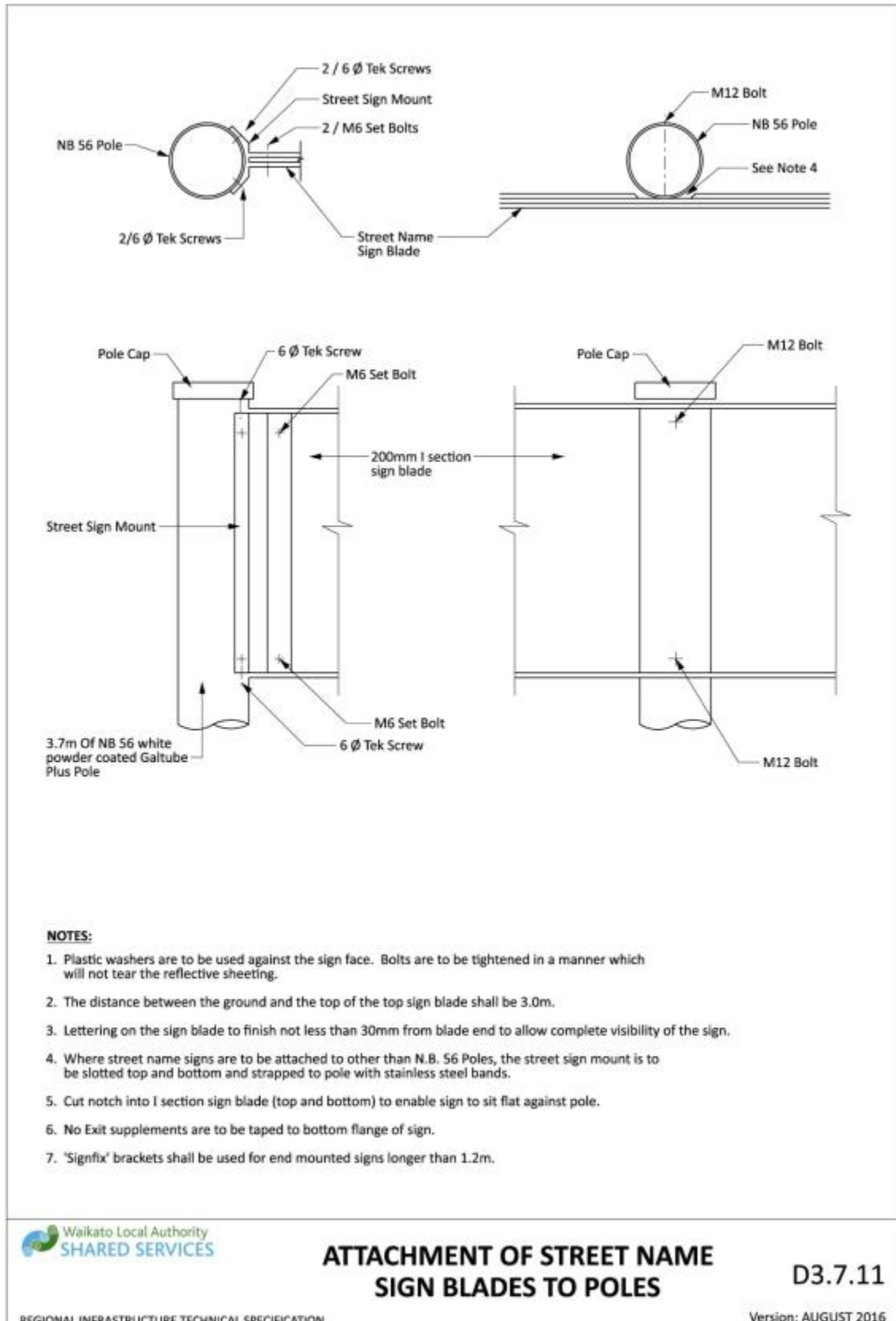

Drawing 3-36: Attachment of street name sign blades to poles

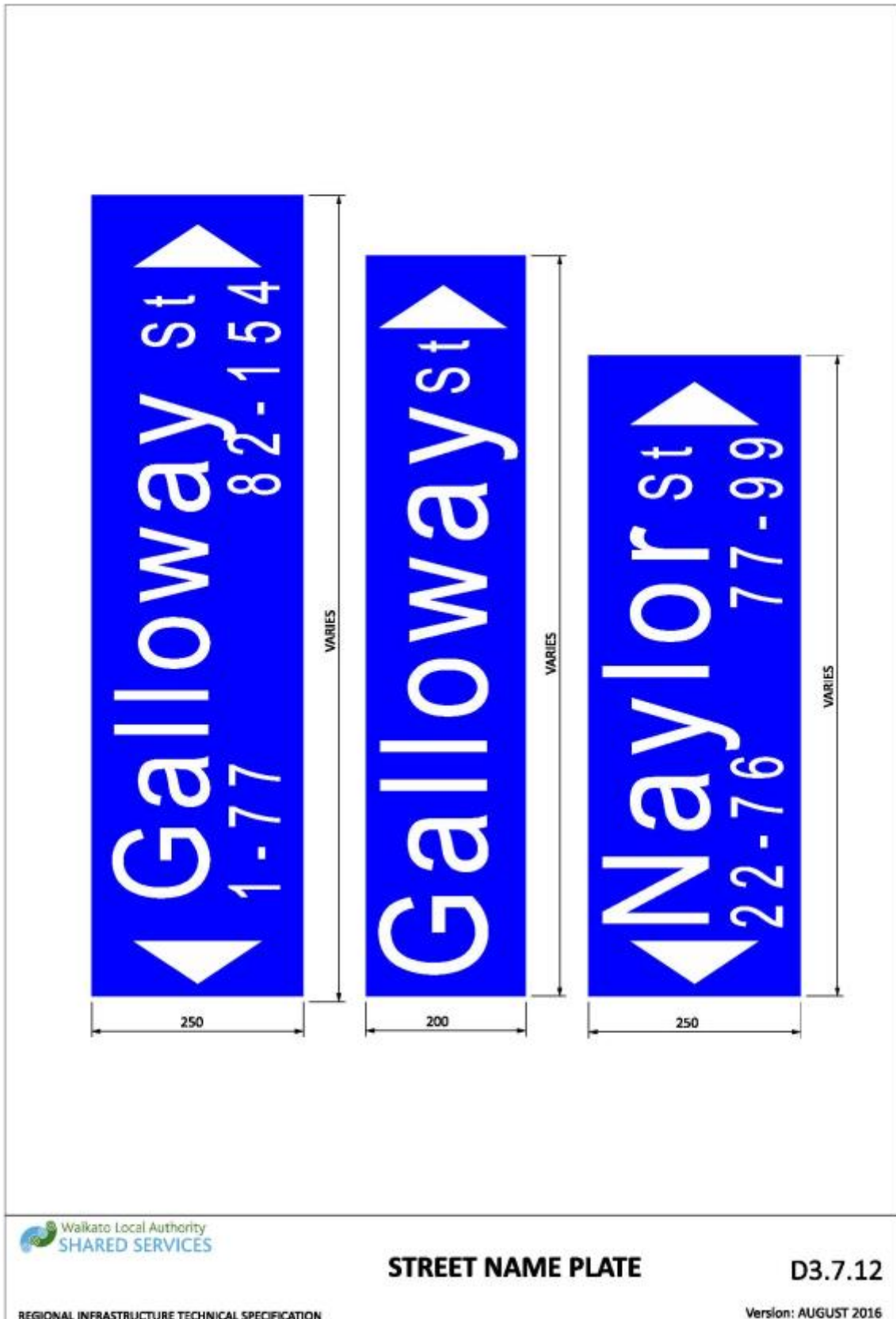

Drawing 3-37: Street name plate

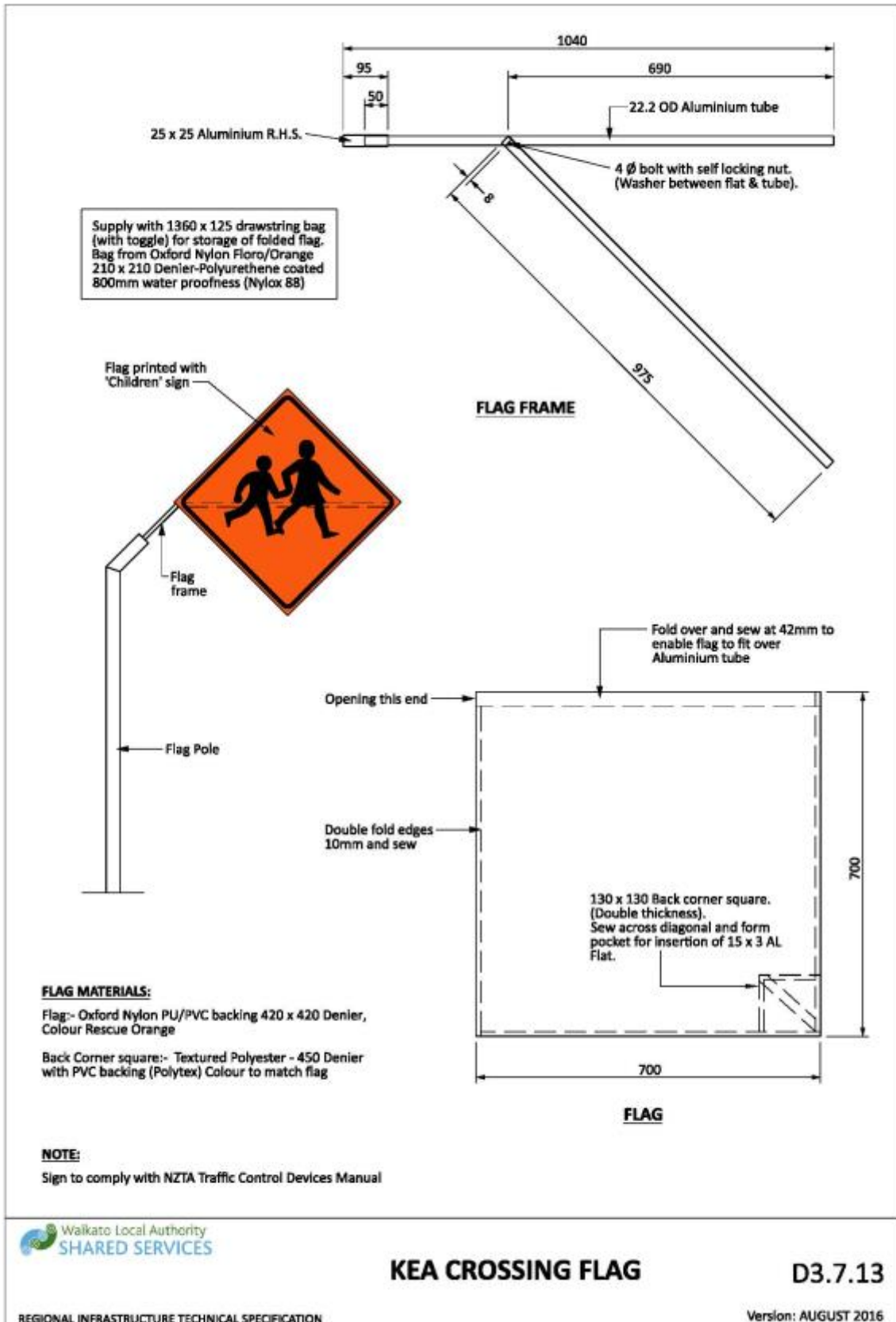

Drawing 3-38: Kea crossing flag

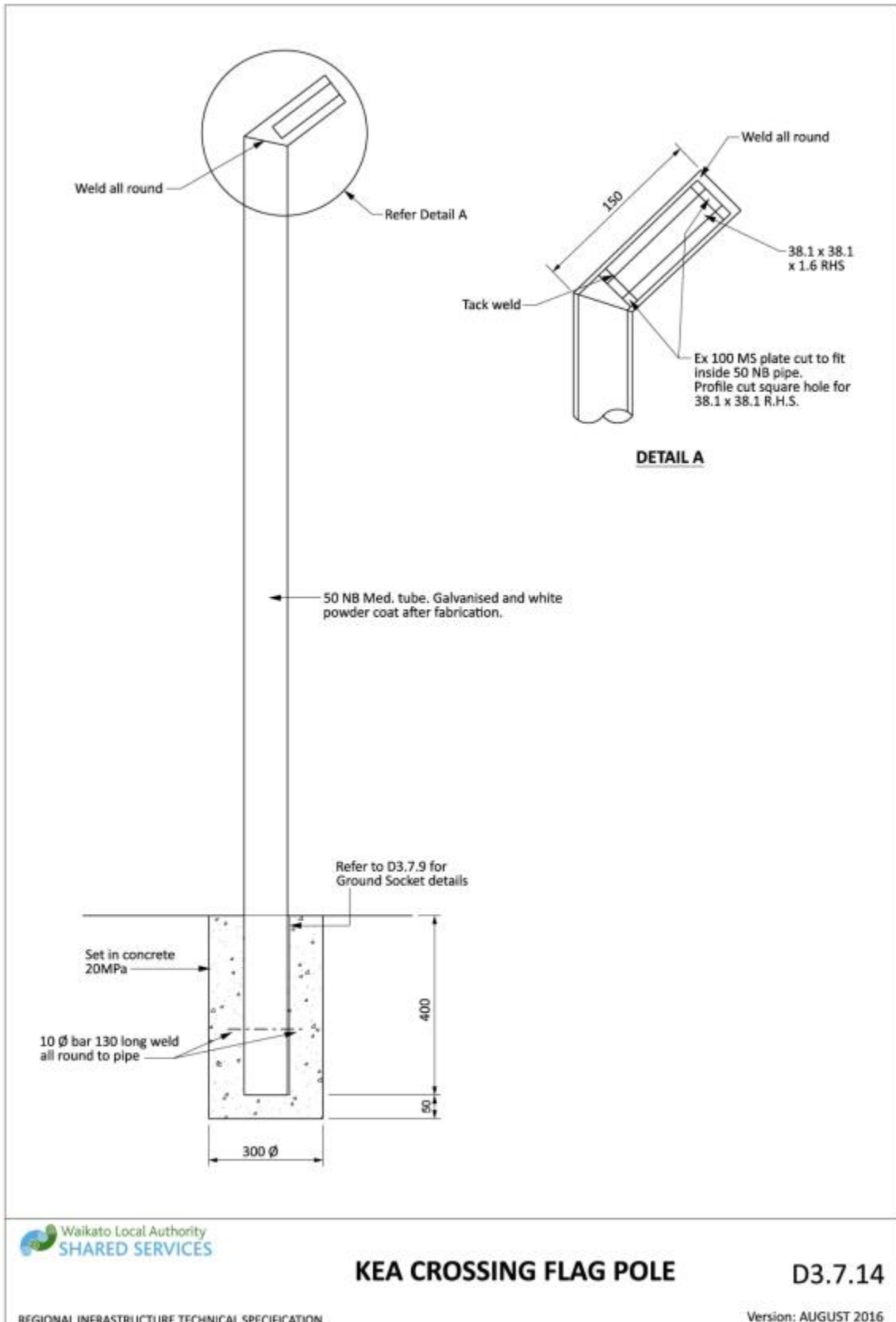

Drawing 3-39: Kea crossing flag pole

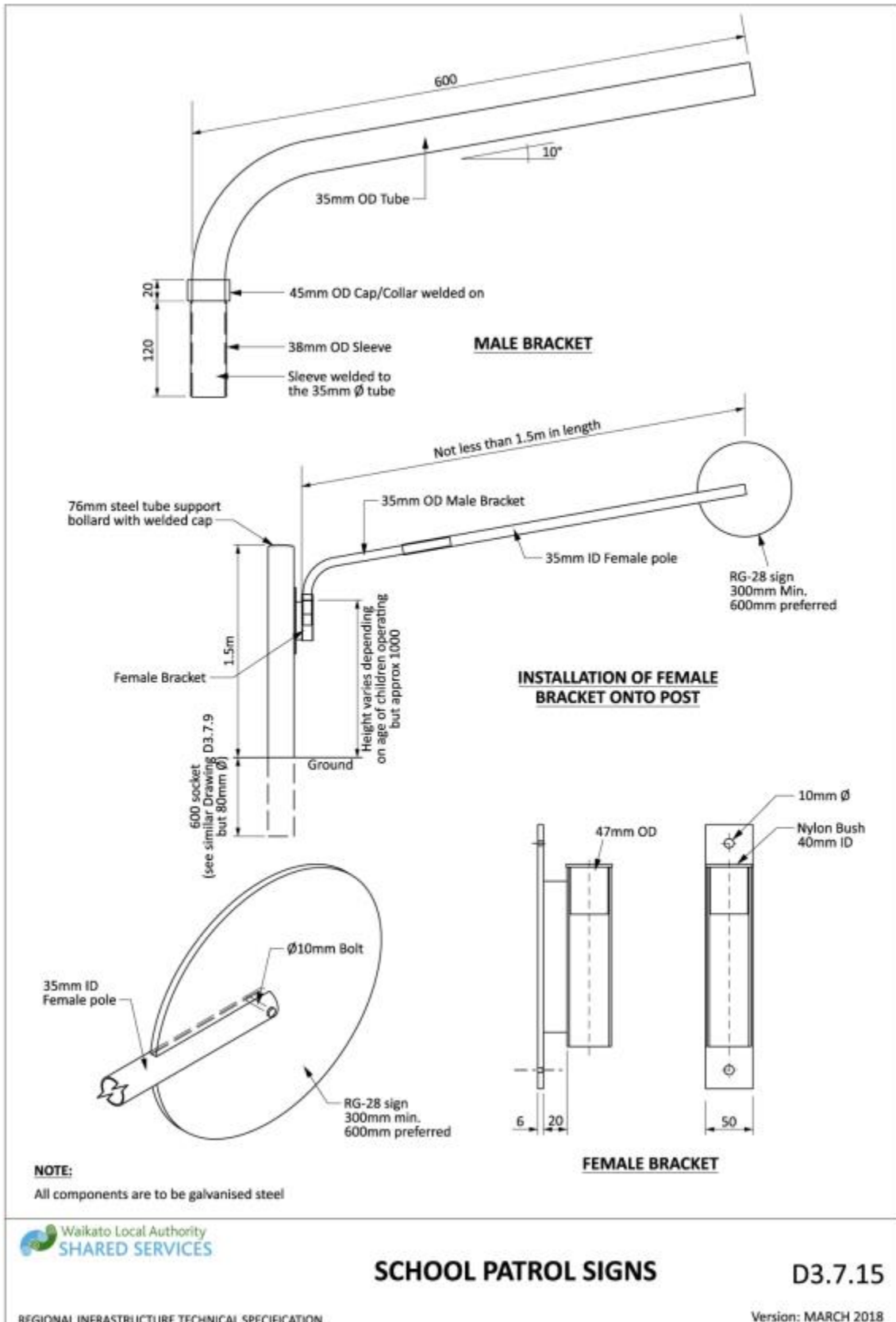

Drawing 3-40: School patrol signs



Drawing 3-41: Bus stop / taxi supplement

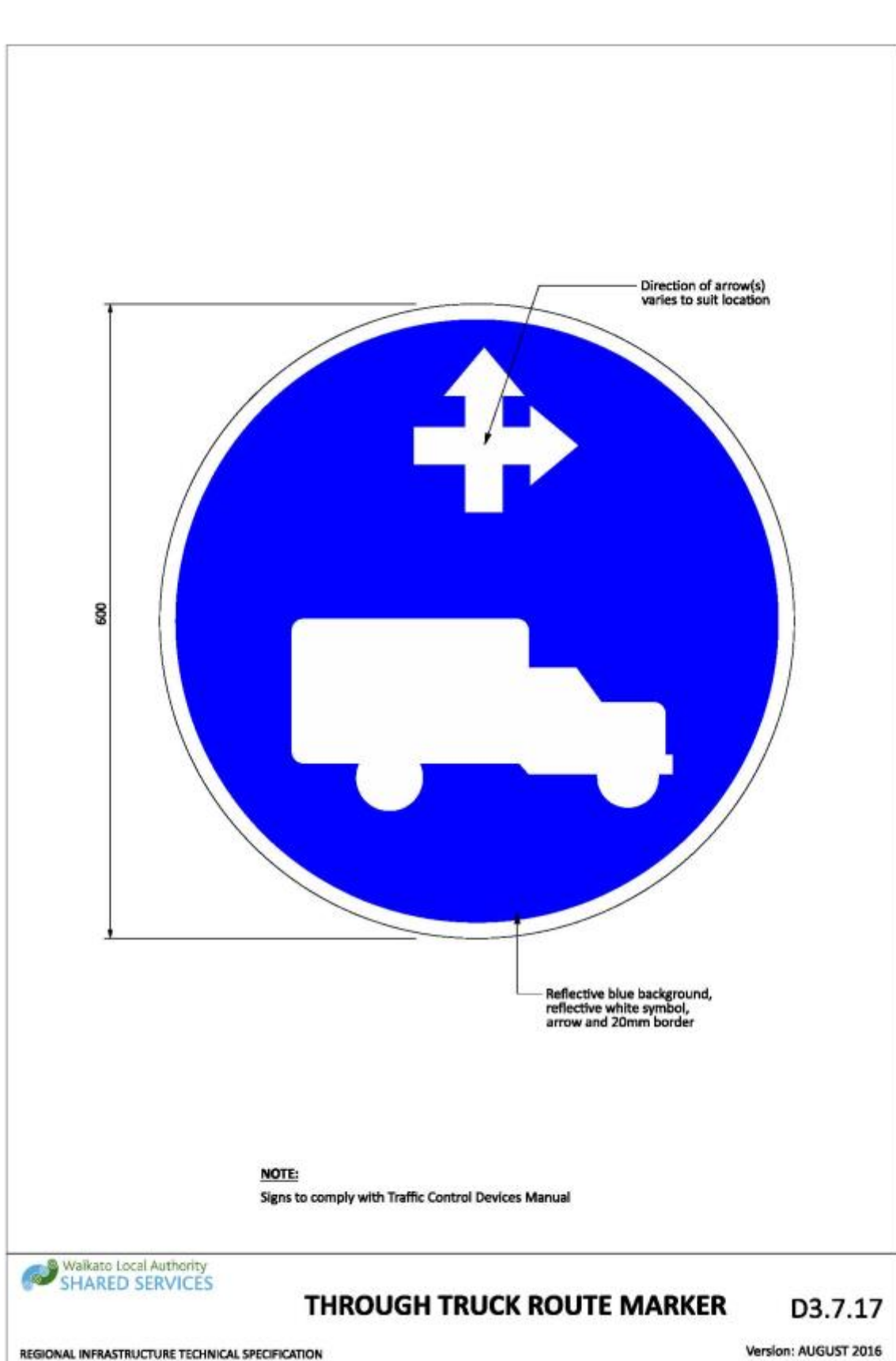

Drawing 3-42: Through truck route marker

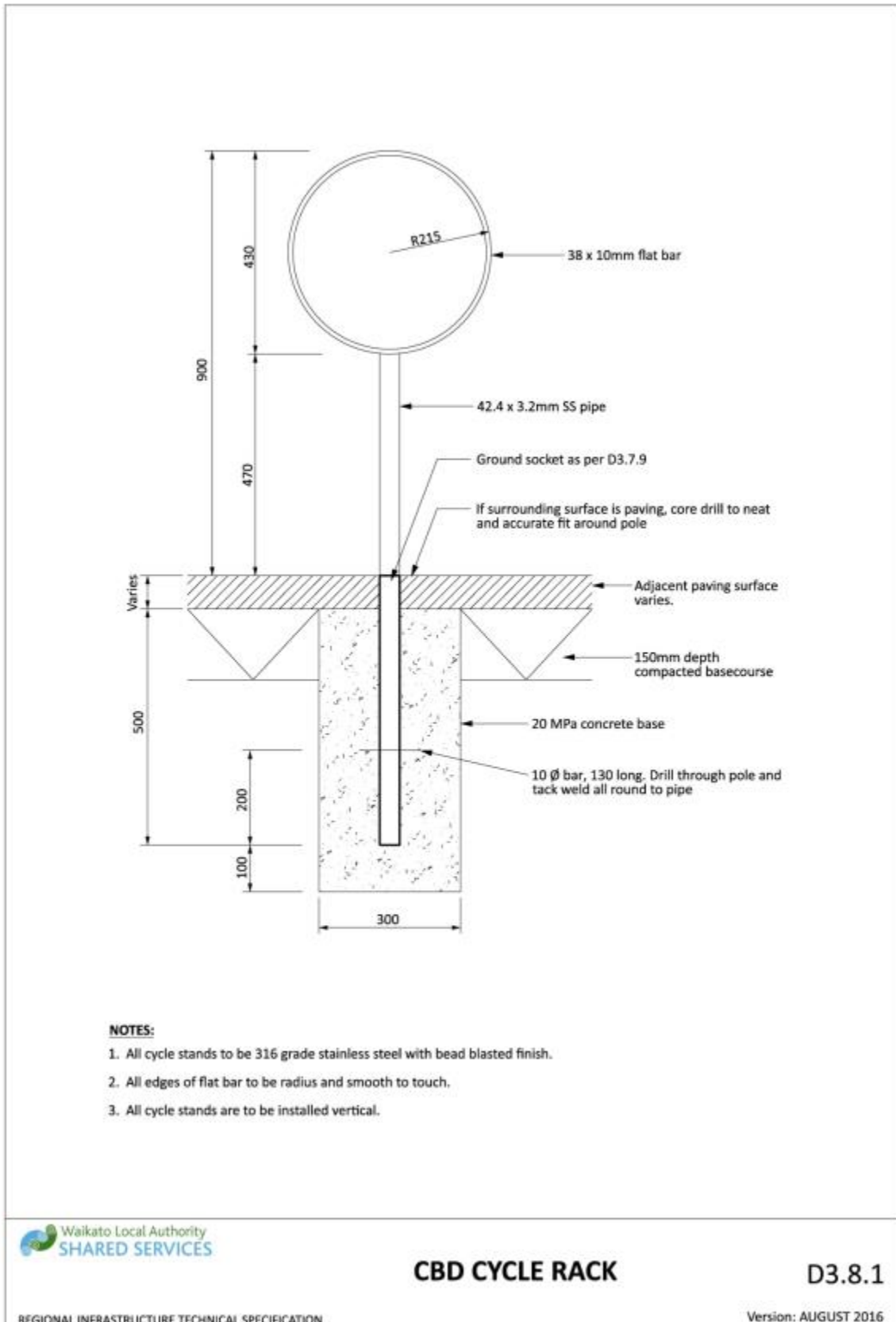

Drawing 3-43: CBD cycle rack

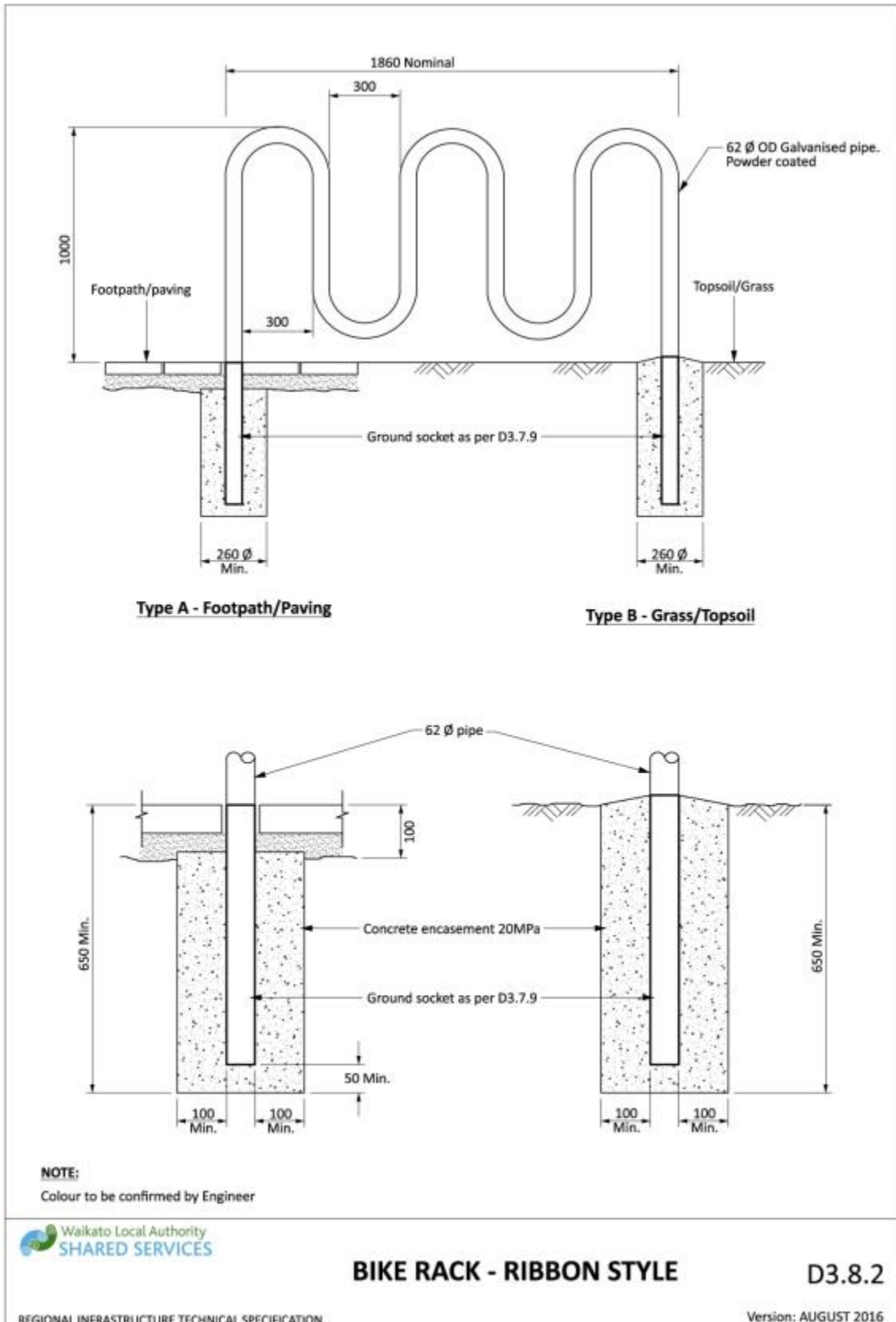

Drawing 3-44: Bike rack - ribbon style

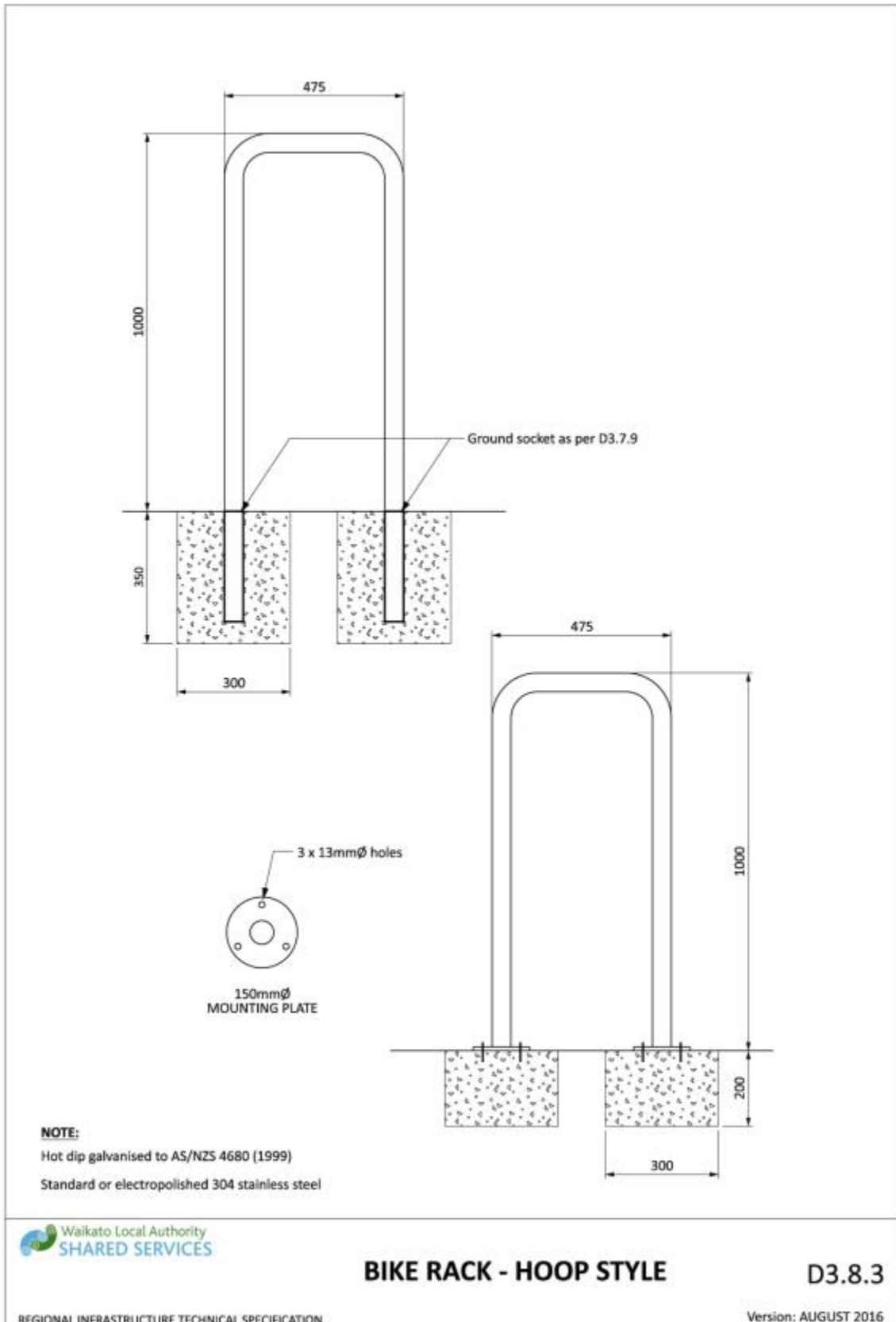

Drawing 3-45: Bike rack - hoop style

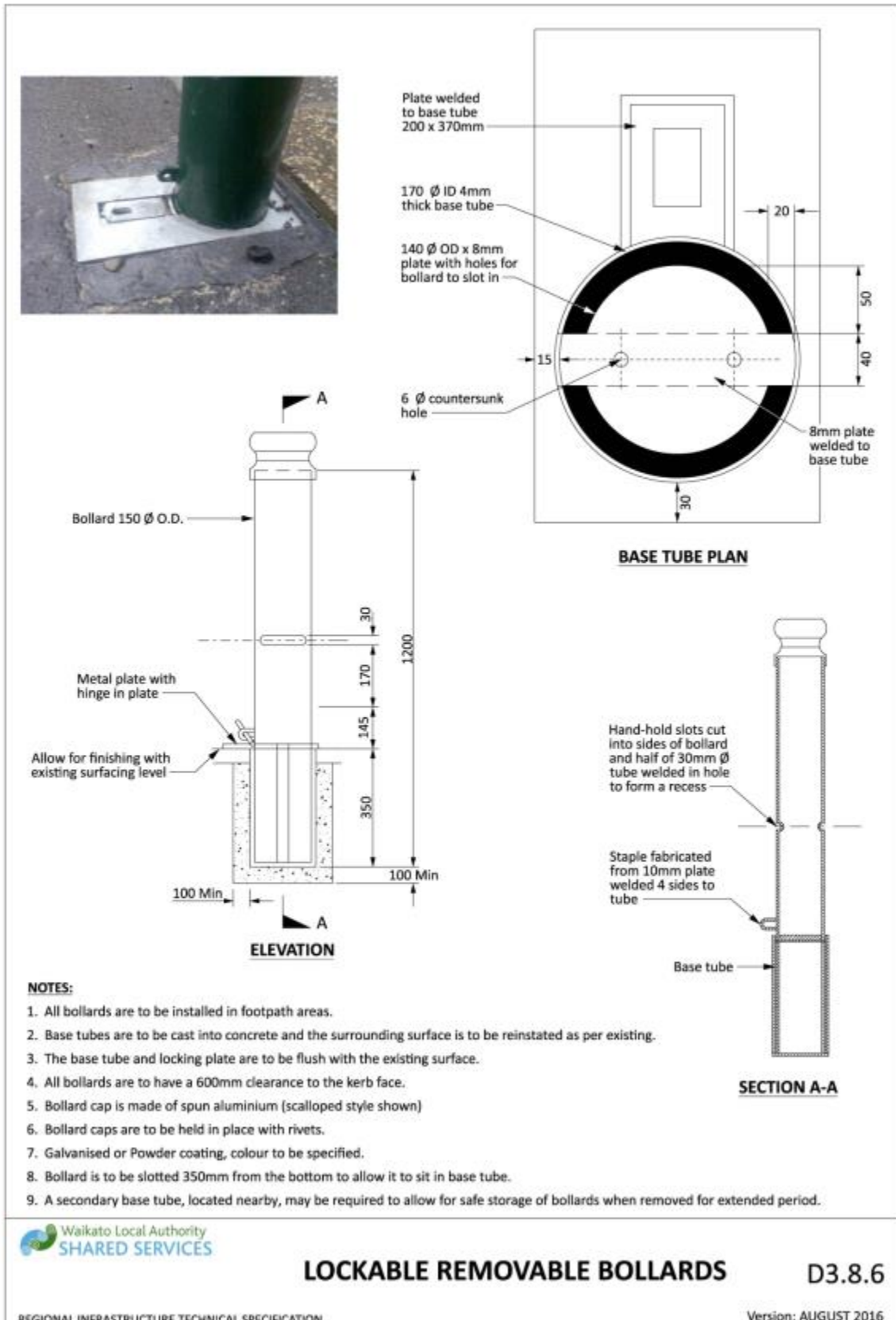

Drawing 3-46: Lockable removable bollards

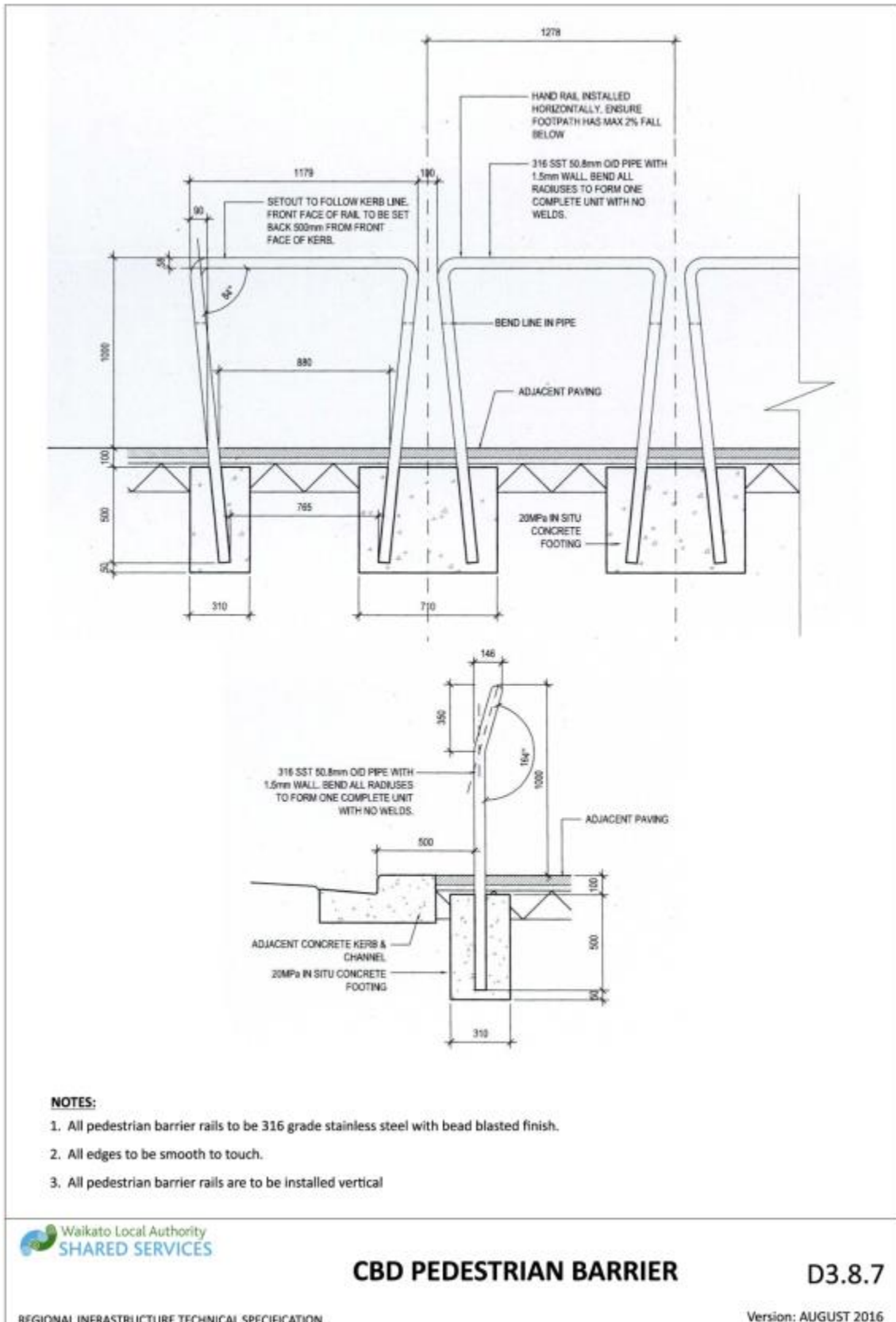

Drawing 3-47: CBD pedestrian barrier

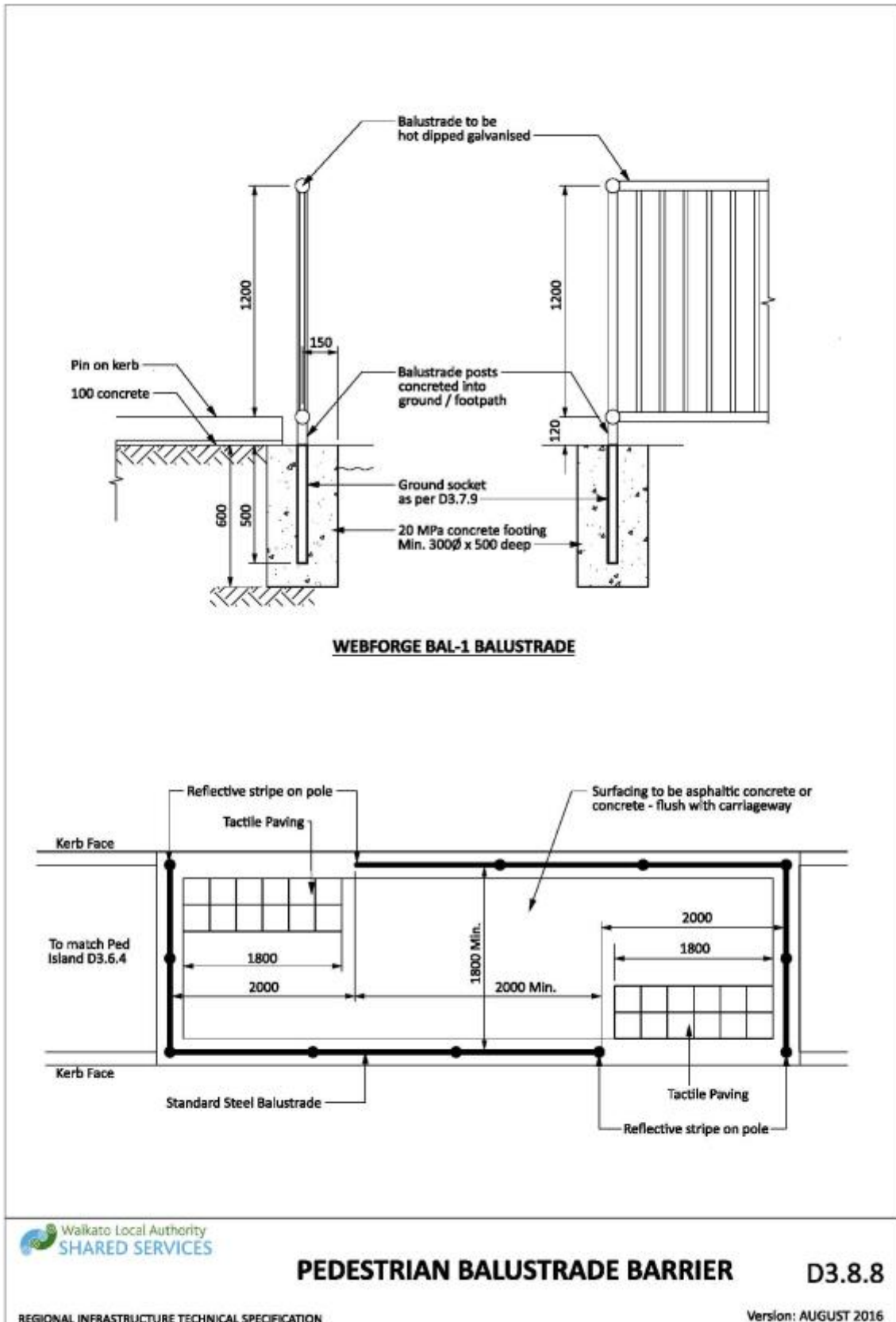

Drawing 3-48: Pedestrian balustrade barrier

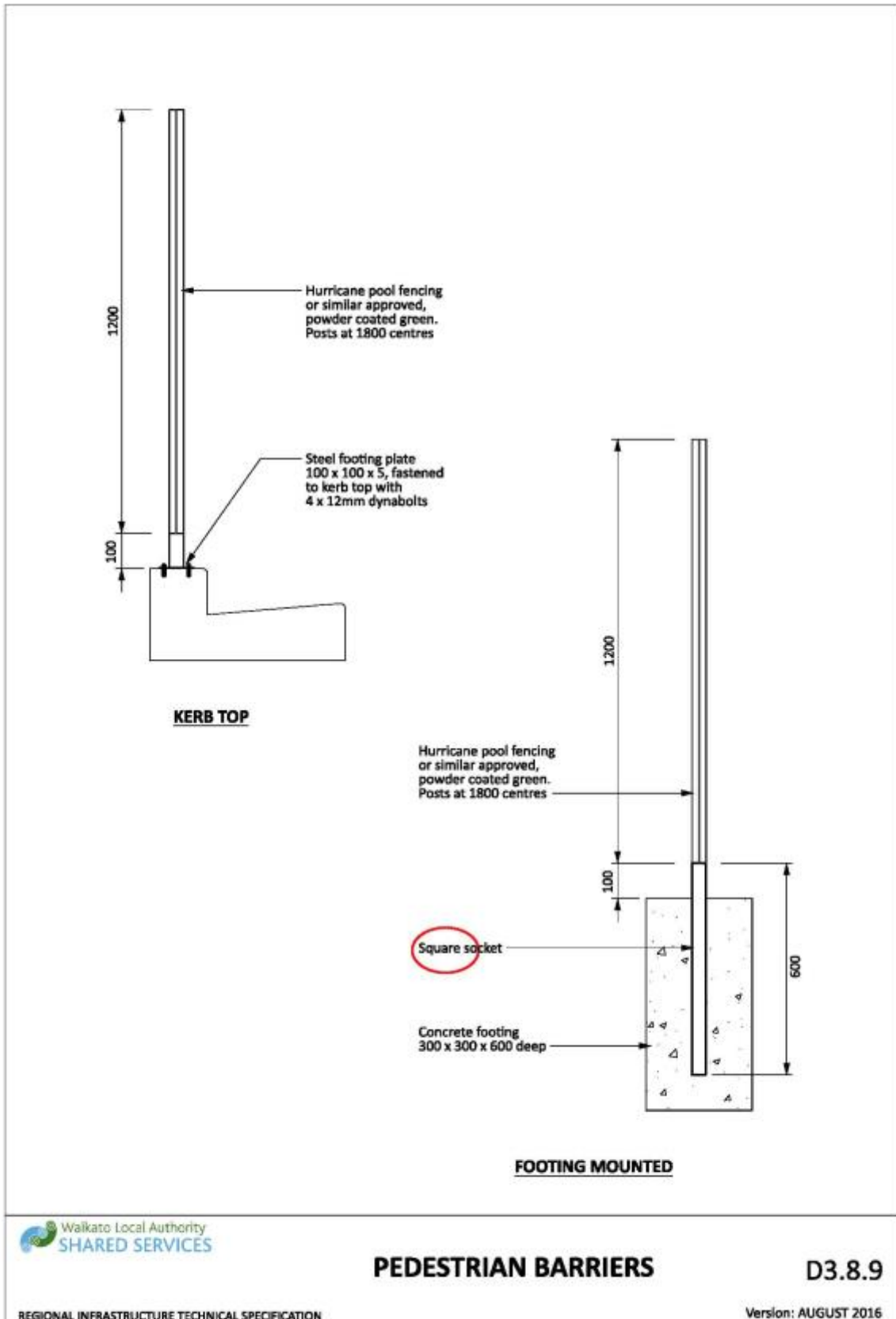

Drawing 3-49: Pedestrian barriers

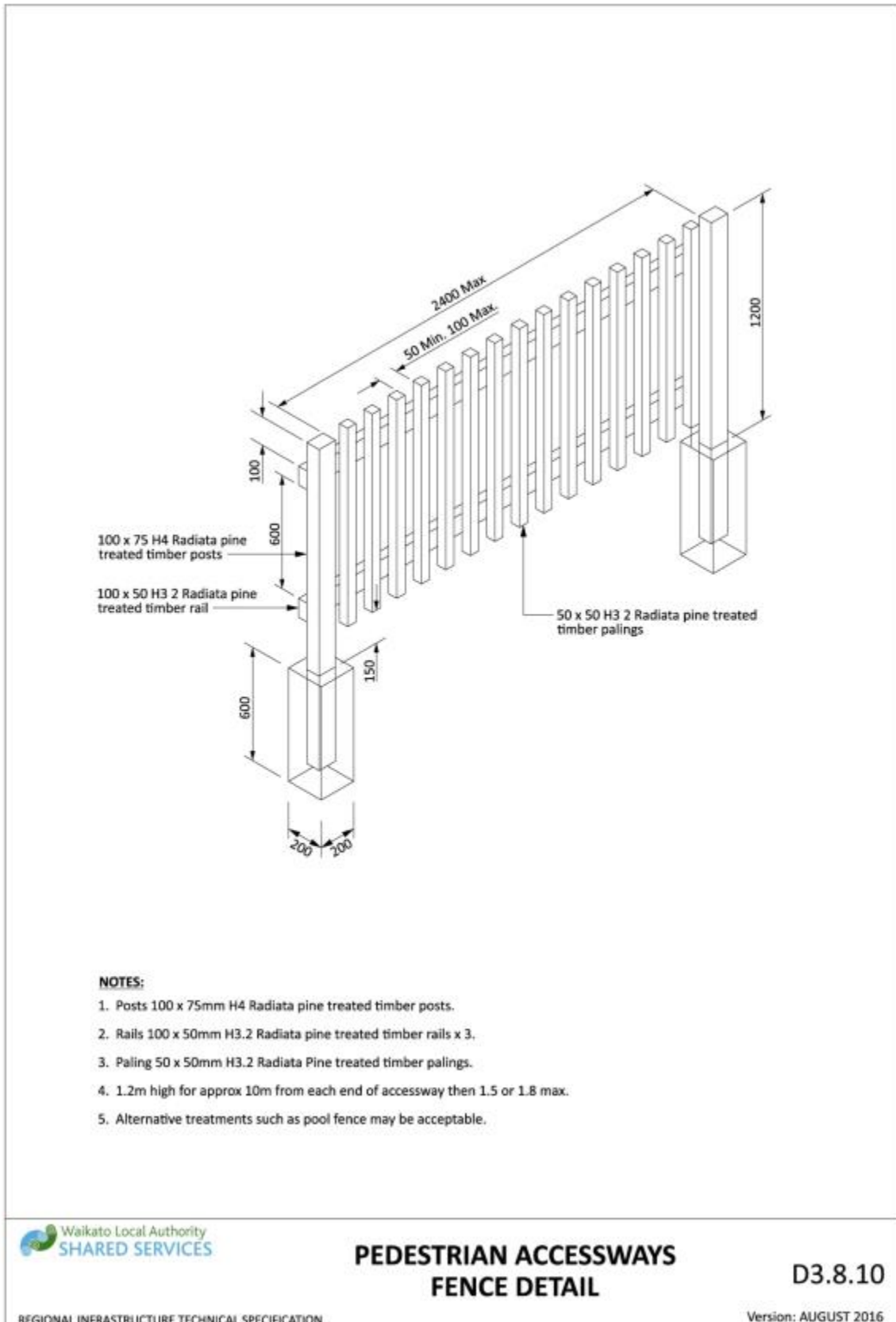

Drawing 3-50: Pedestrian accessways fence detail

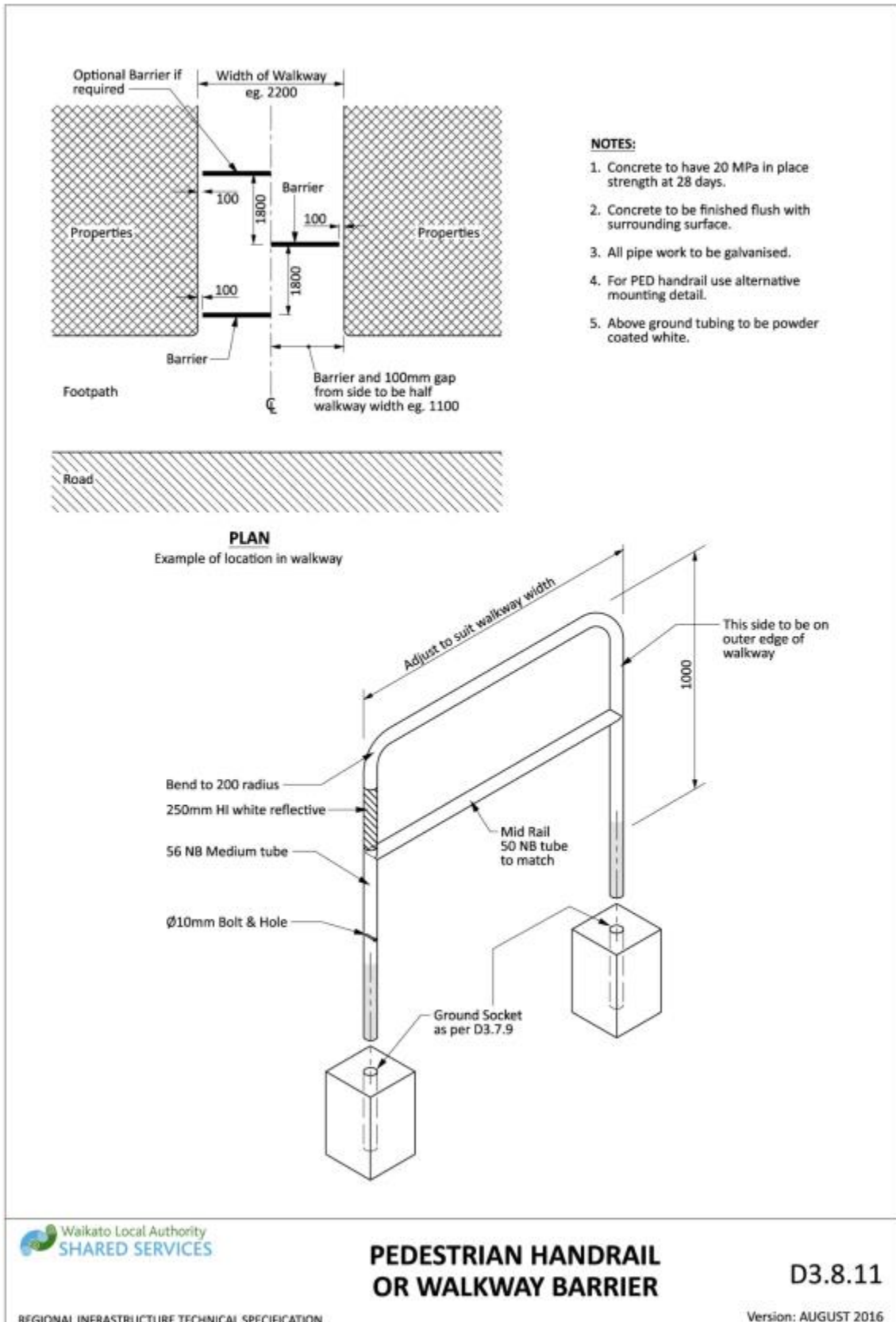

Drawing 3-51: Pedestrian handrail or walkway barrier

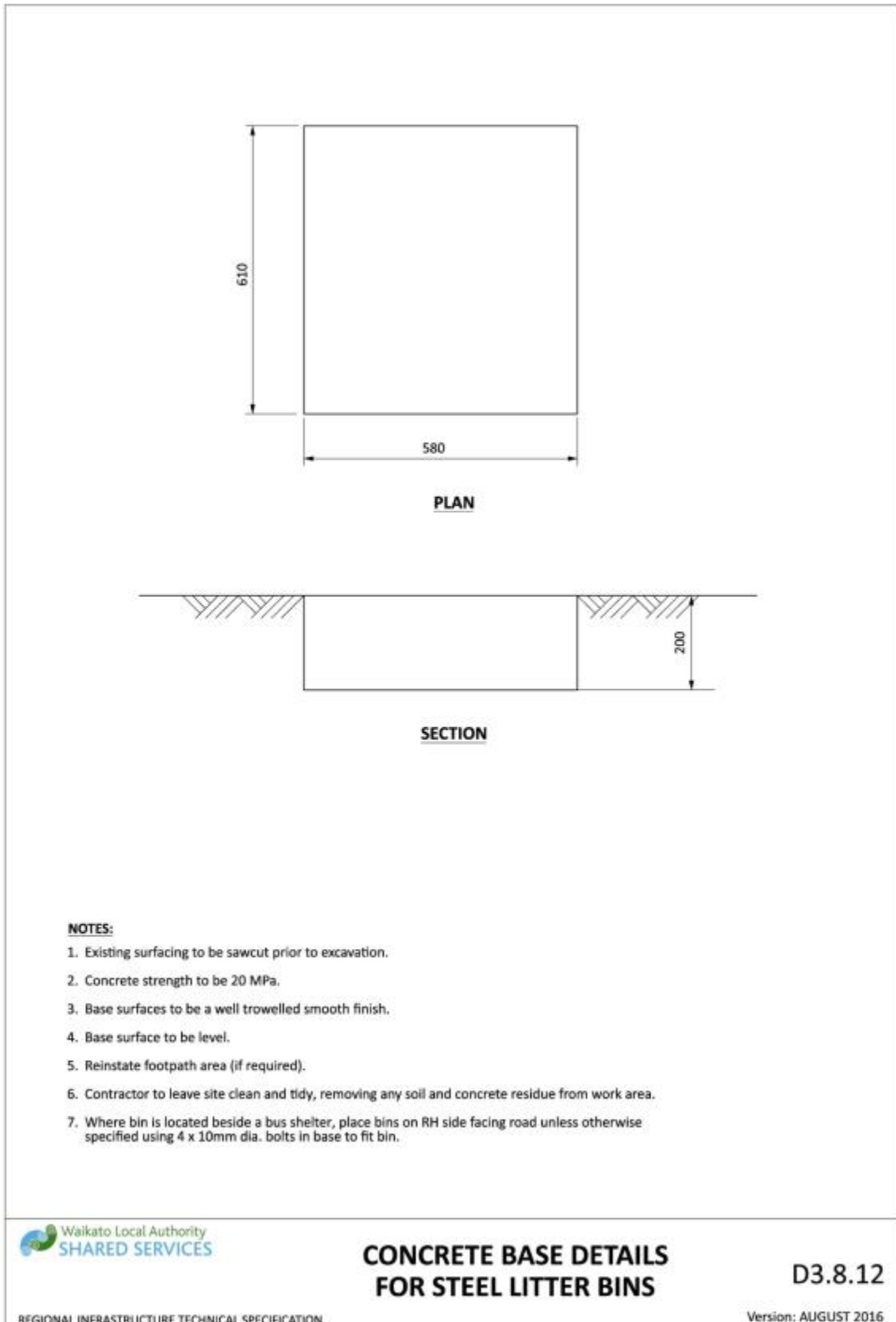

Drawing 3-52: Concrete base details for steel litter bins

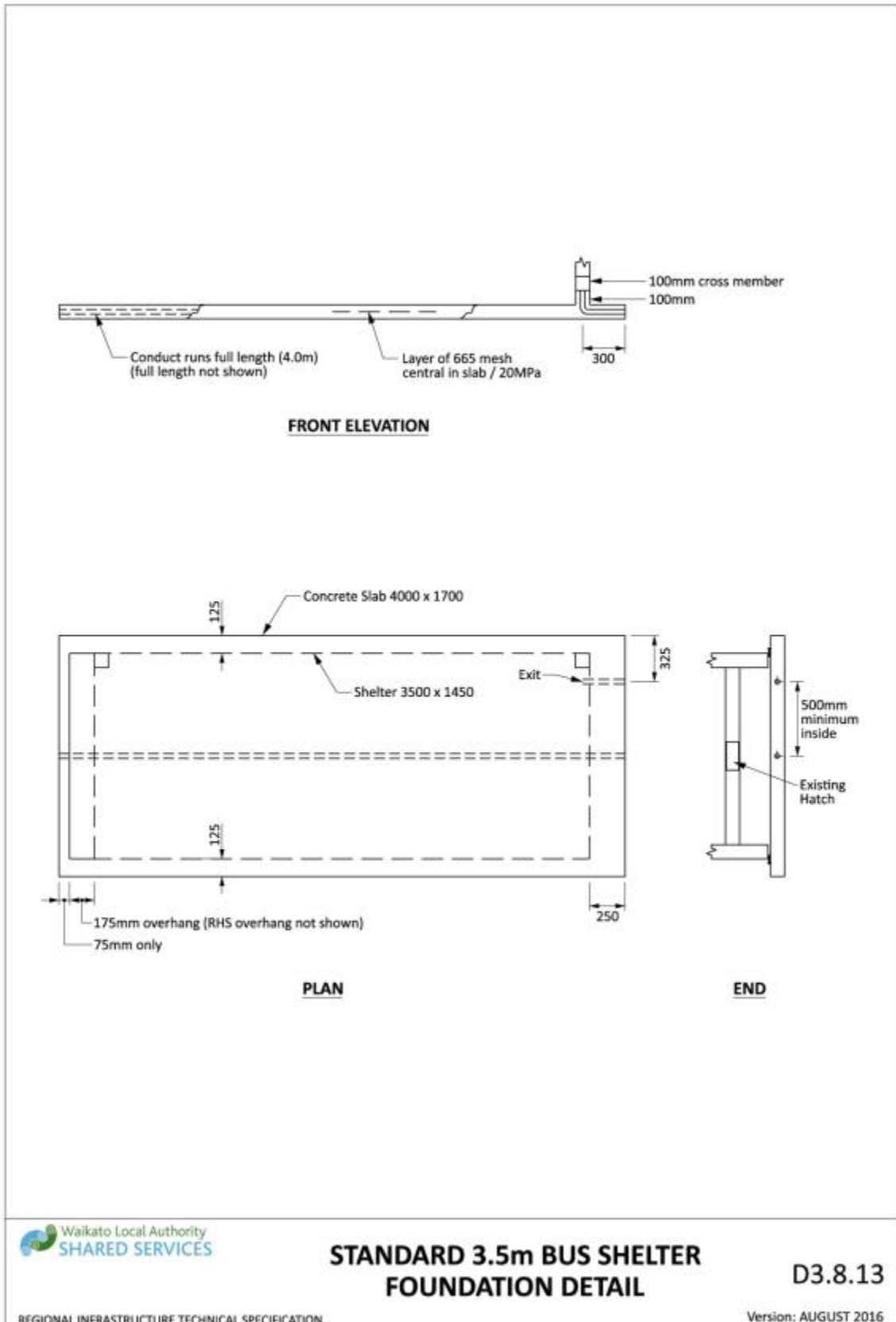

Drawing 3-53: Standard 3.5m bus shelter foundation detail

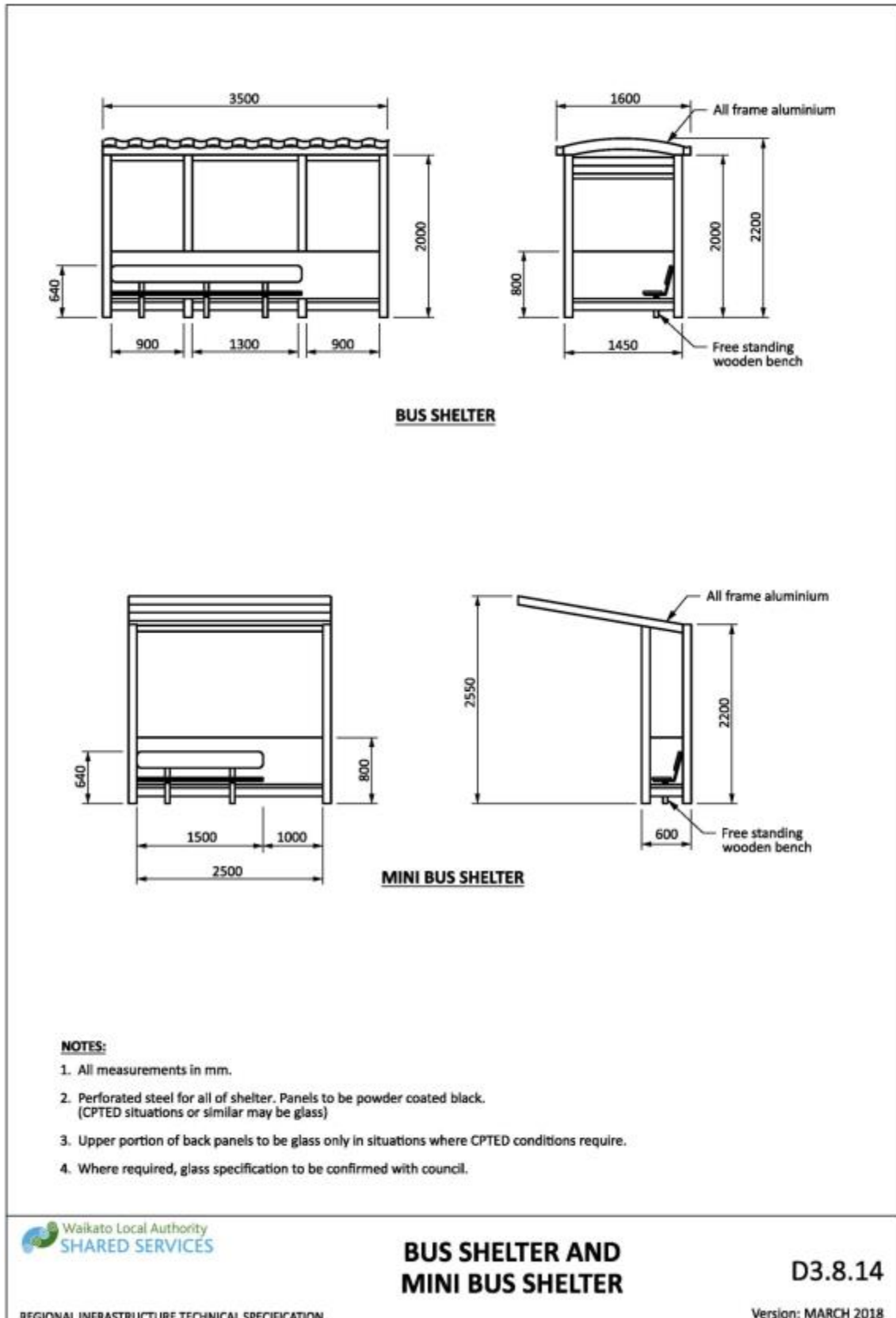

Drawing 3-54: Bus shelter and mini bus shelter

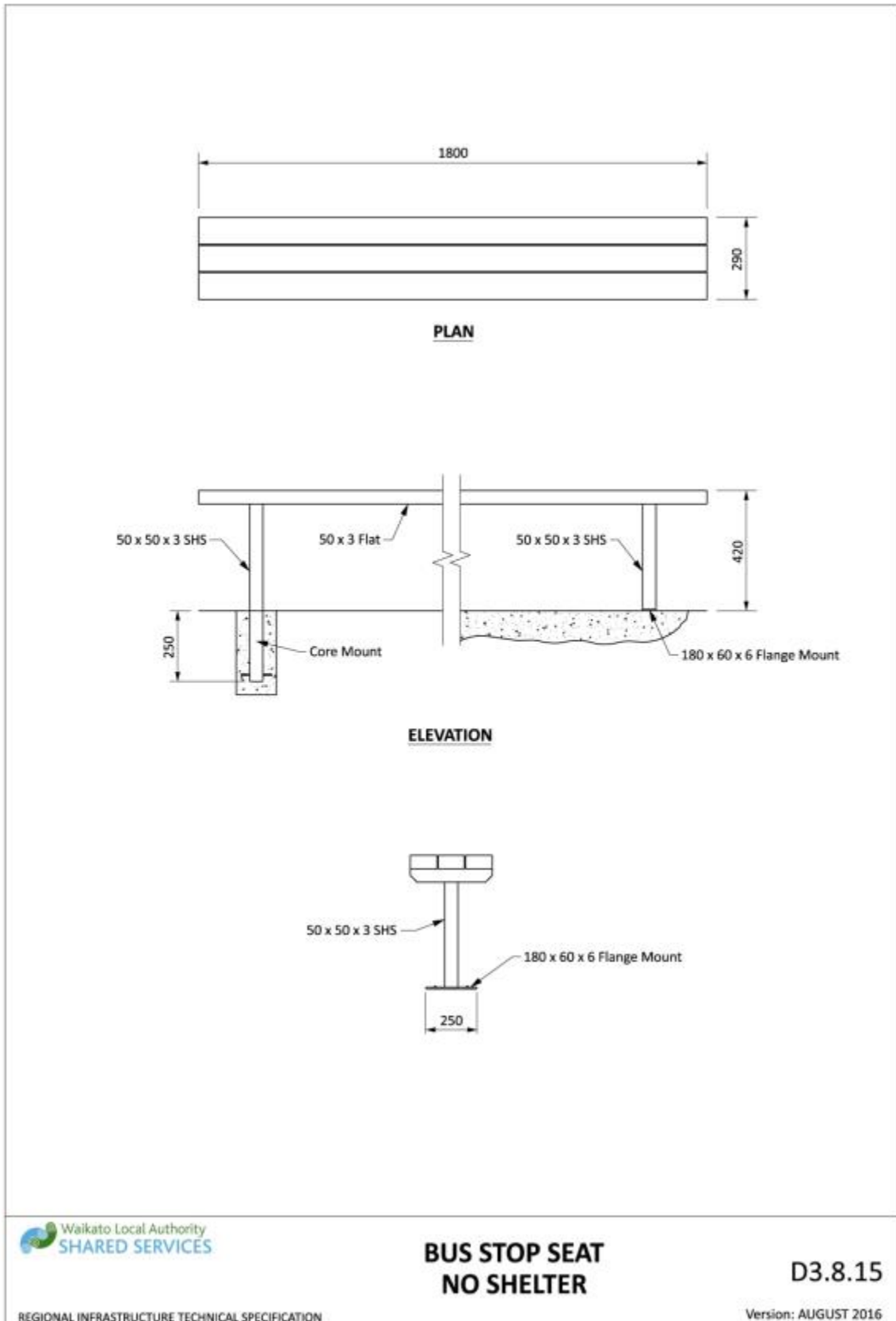

Drawing 3-55: Bus stop seat no shelter

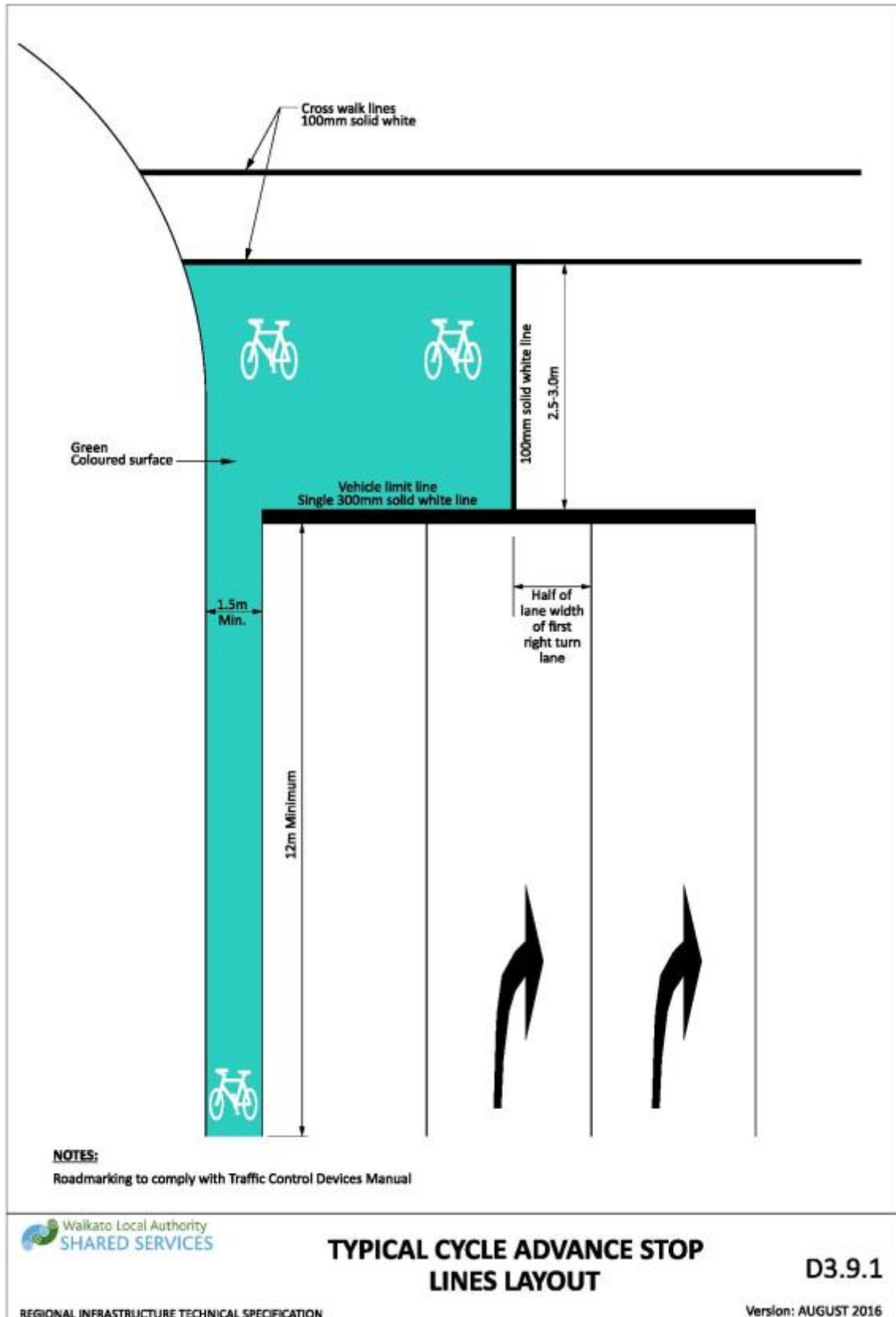

Drawing 3-56: Typical cycle advance stop lines layout

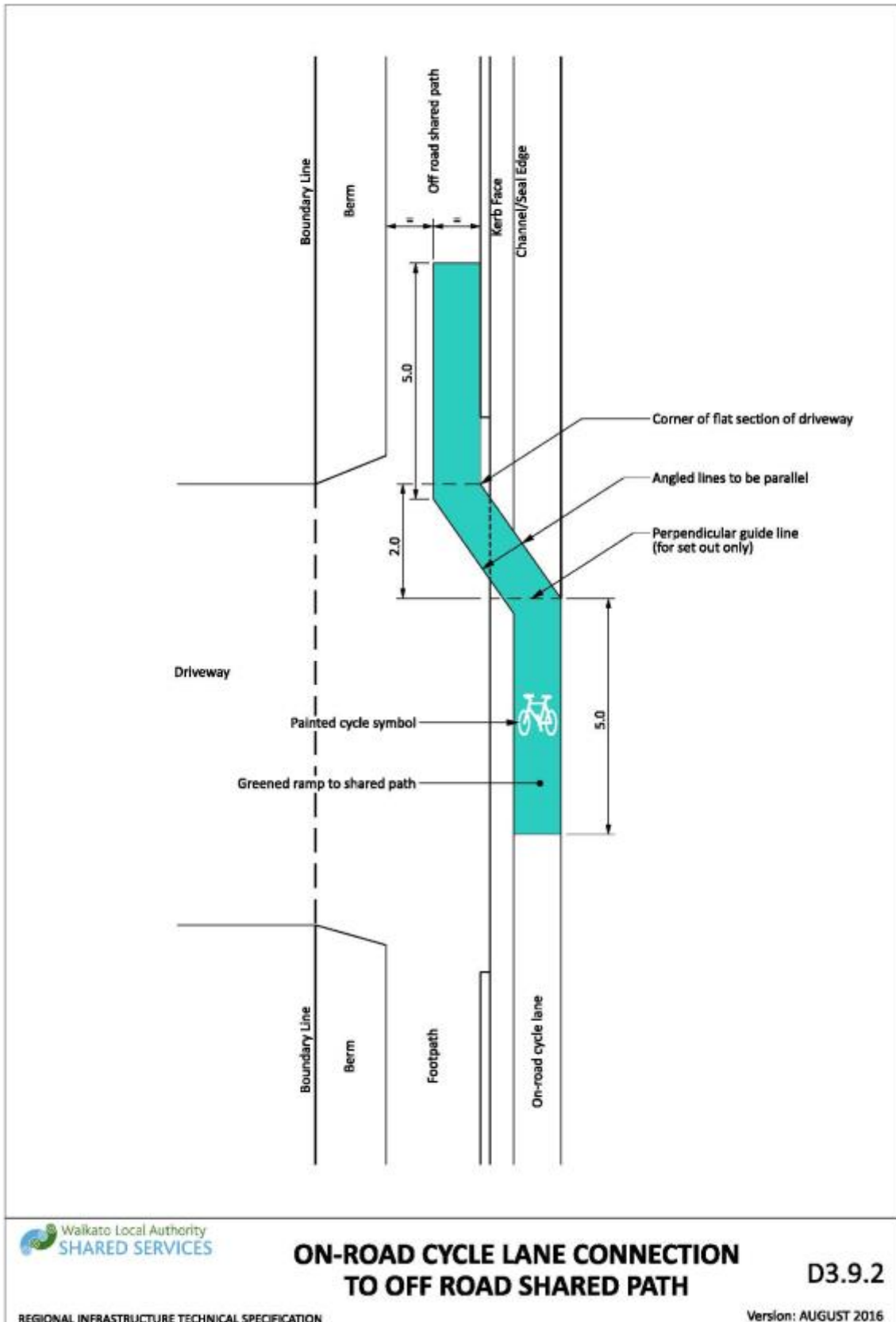

Drawing 3-57: On-road cycle lane connection to off road shared path

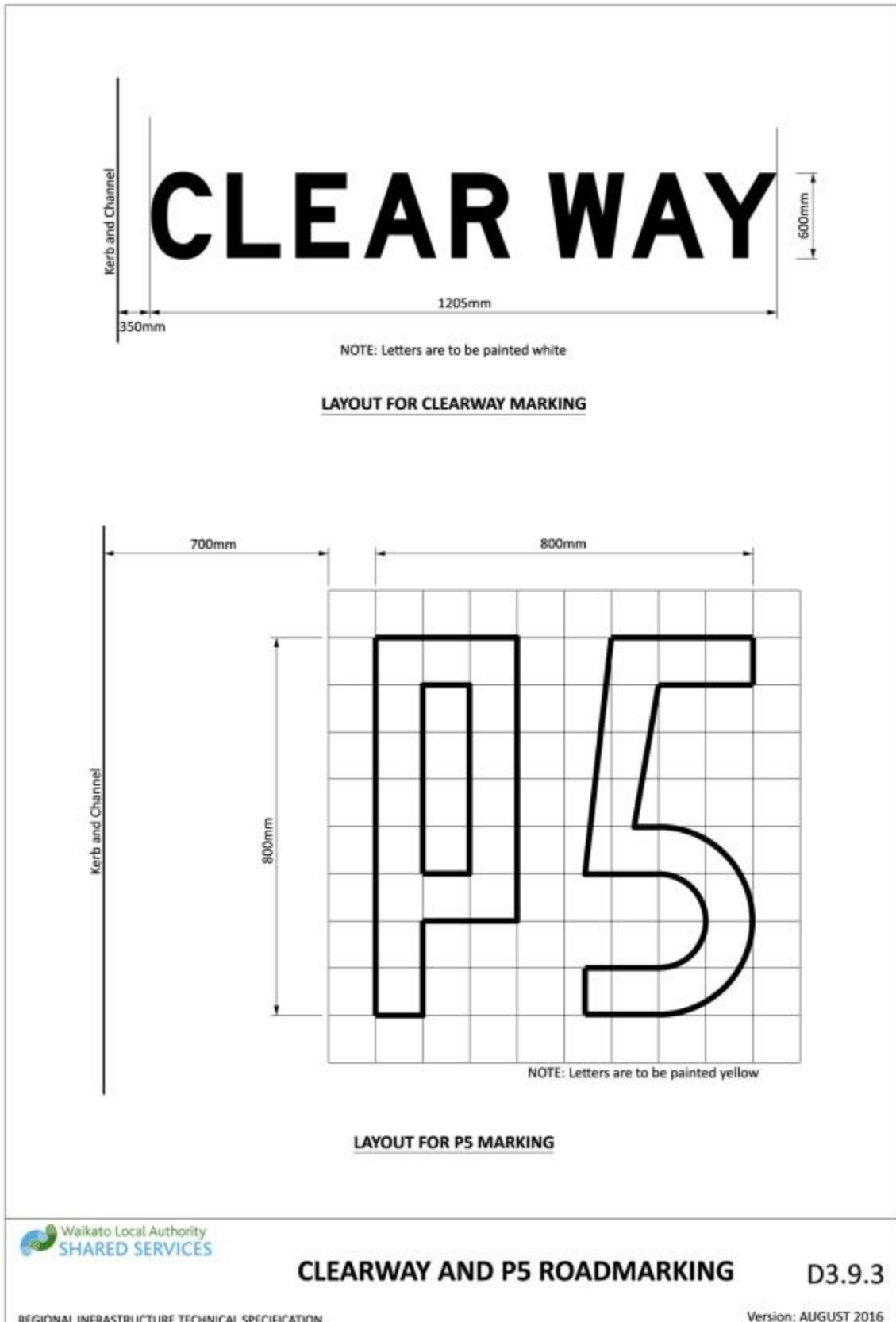

Drawing 3-58: Clearway and P5 roadmarking

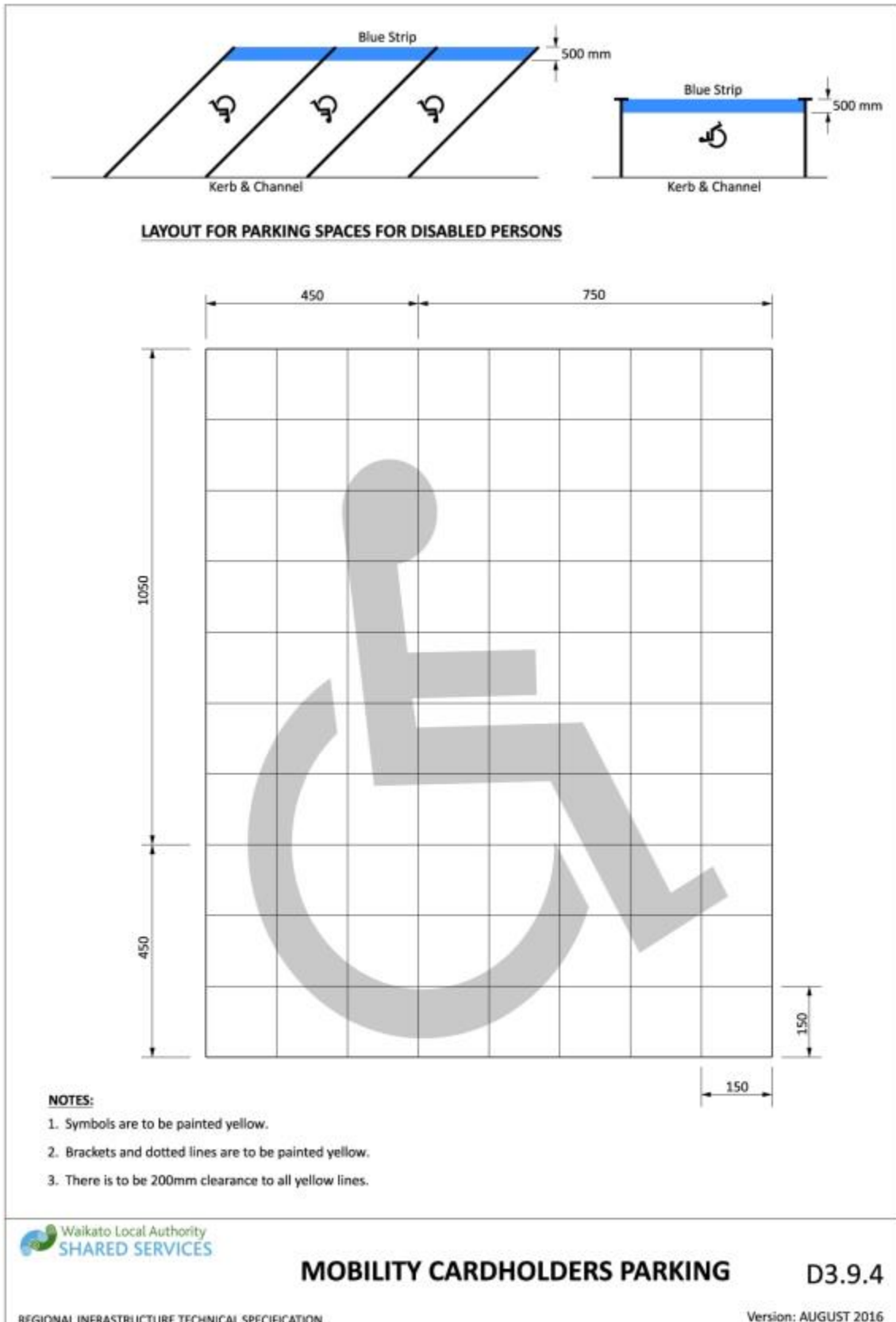

Drawing 3-59: Mobility cardholders parking

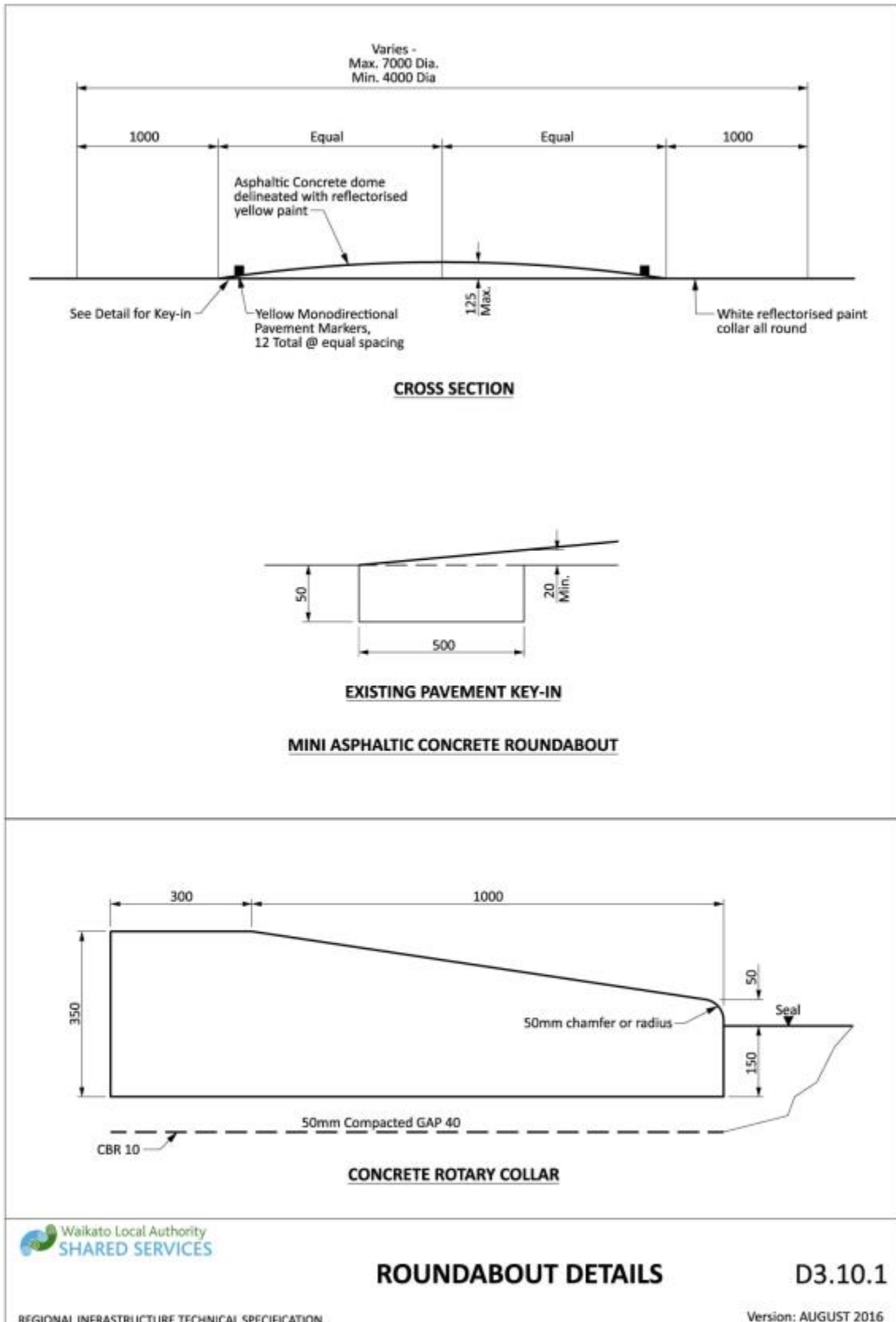

Drawing 3-60: Roundabout details

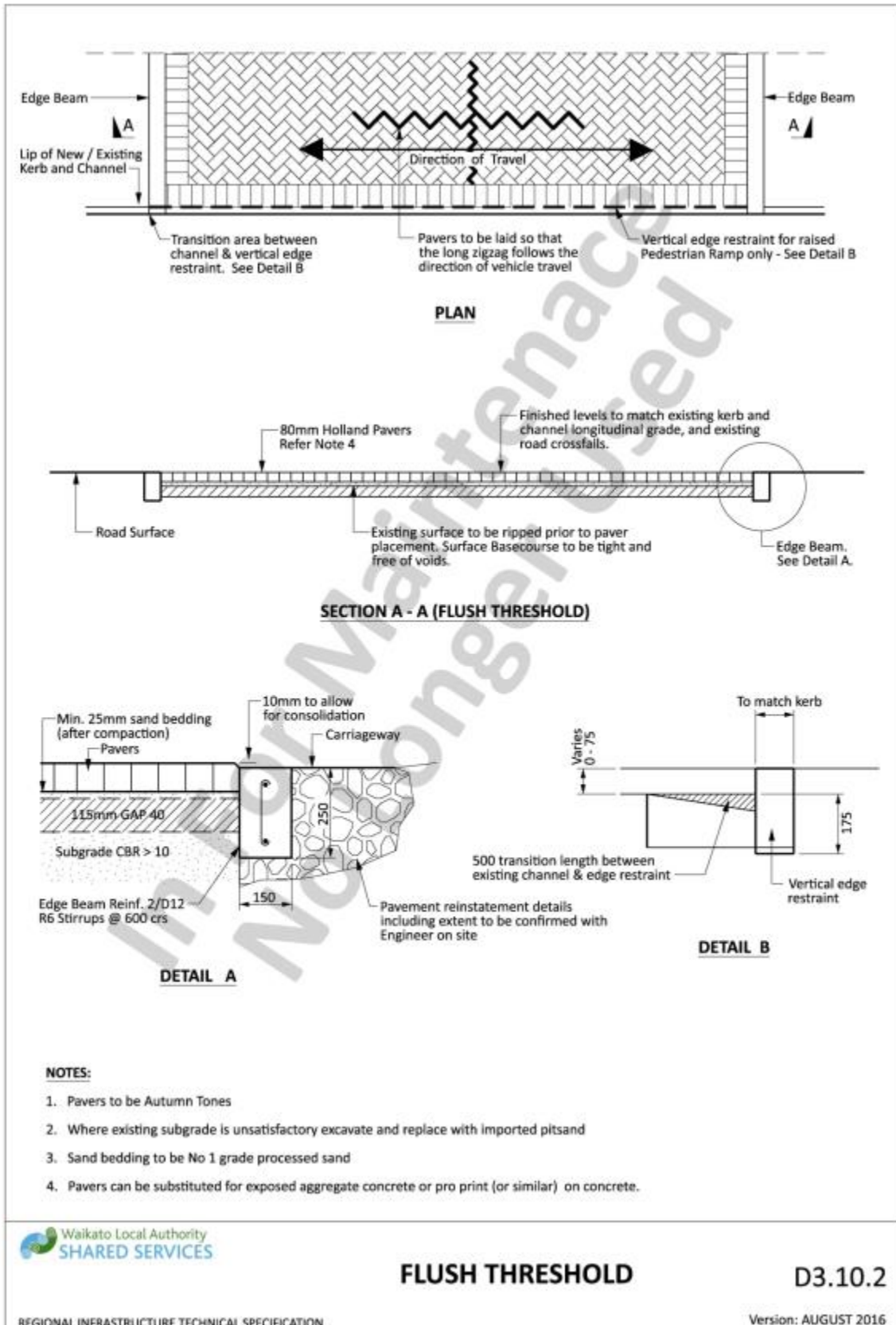

Drawing 3-61: Flush threshold

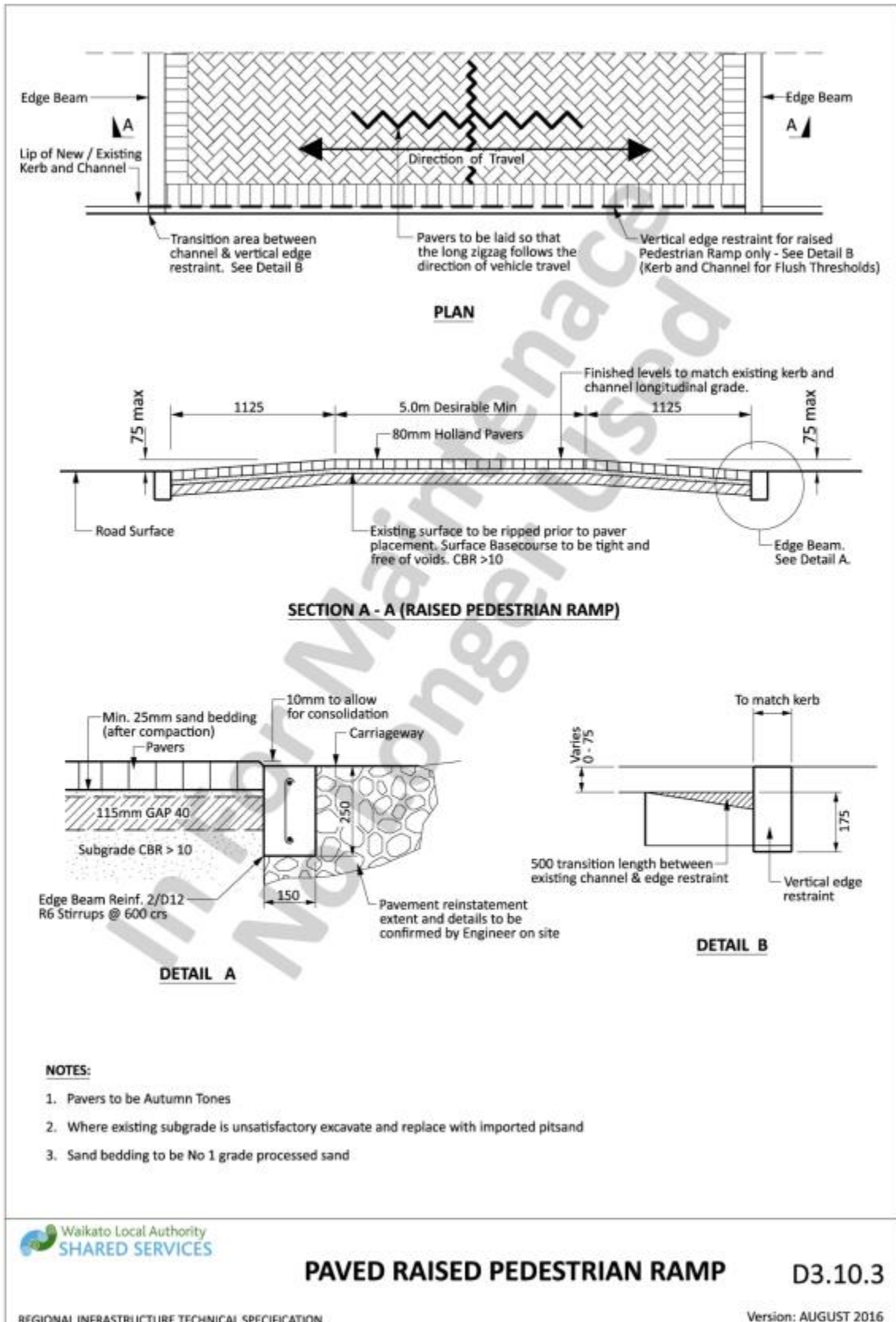

Drawing 3-62: Paved raised pedestrian ramp

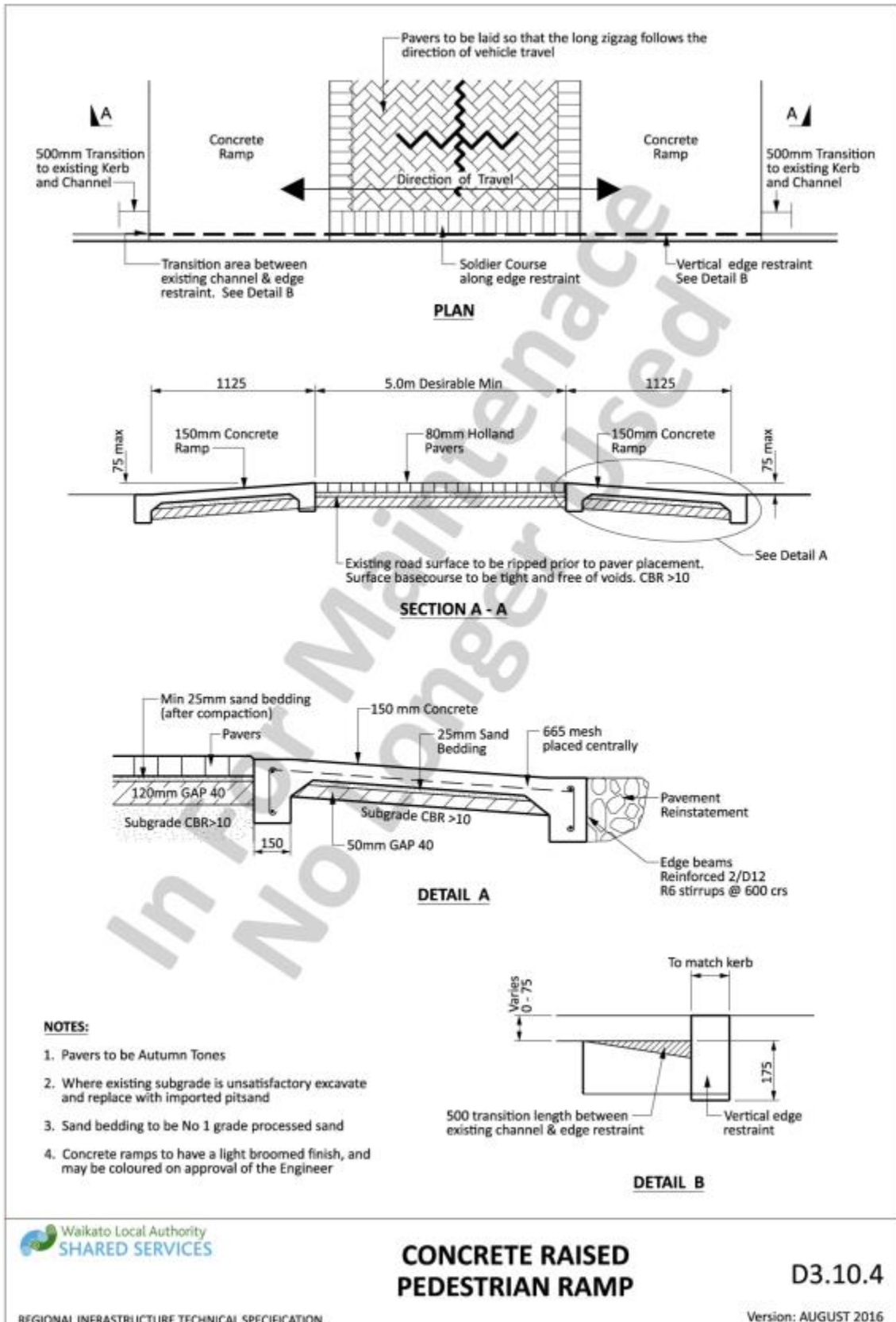

Drawing 3-63: Concrete raised pedestrian ramp

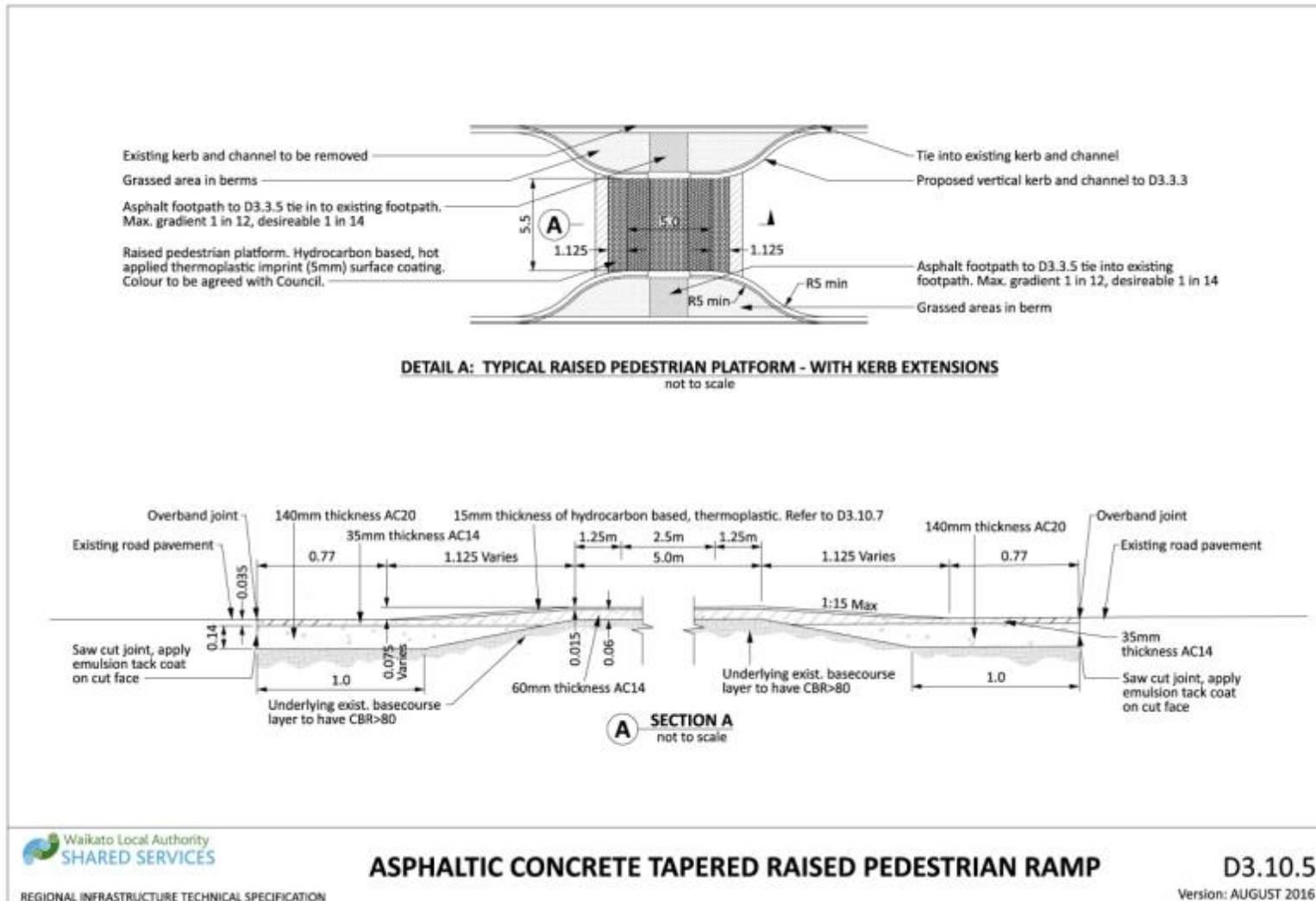

Drawing 3-64: Asphaltic concrete tapered raised pedestrian ramp

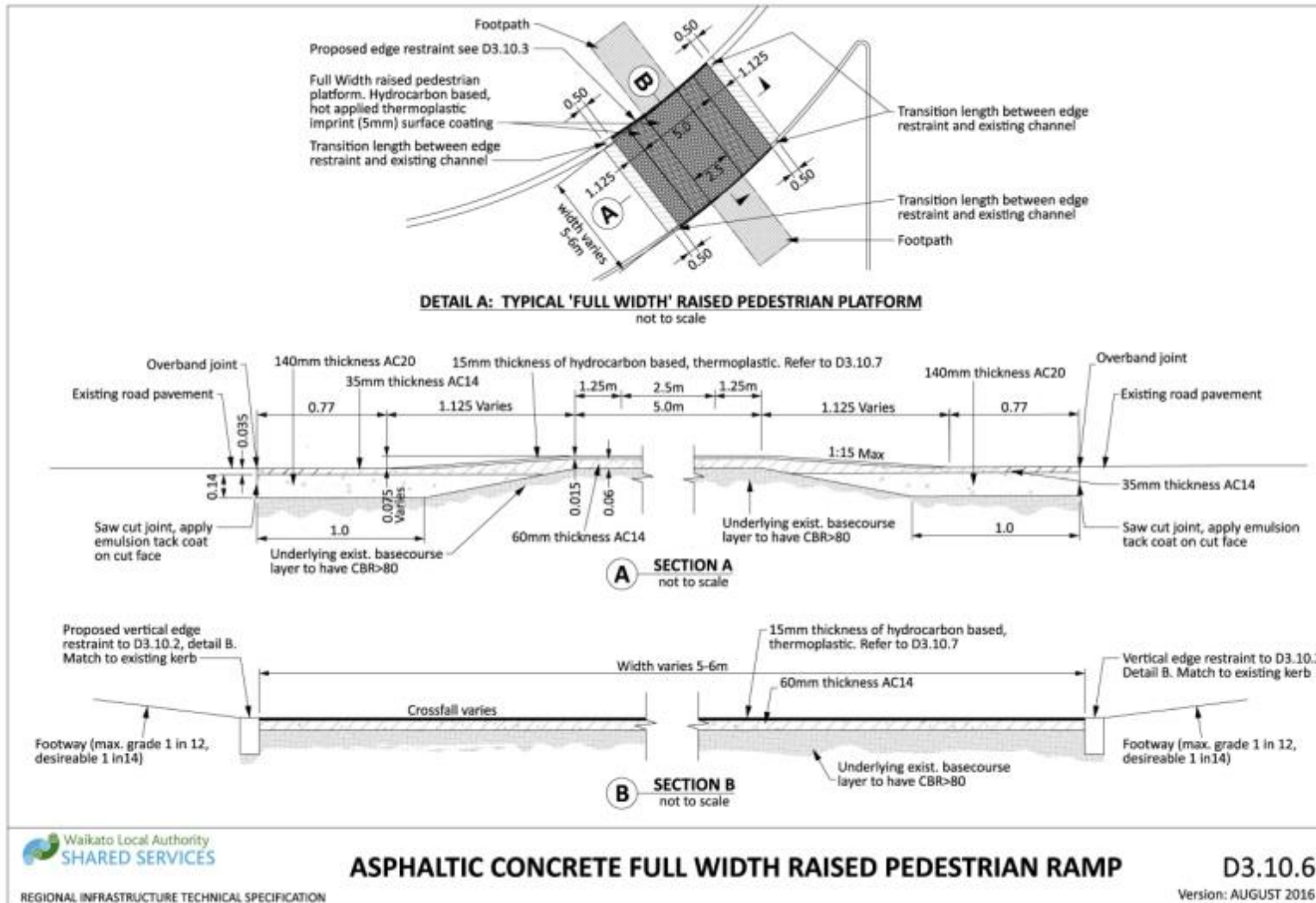

Drawing 3-65: Asphaltic concrete full width raised pedestrian ramp

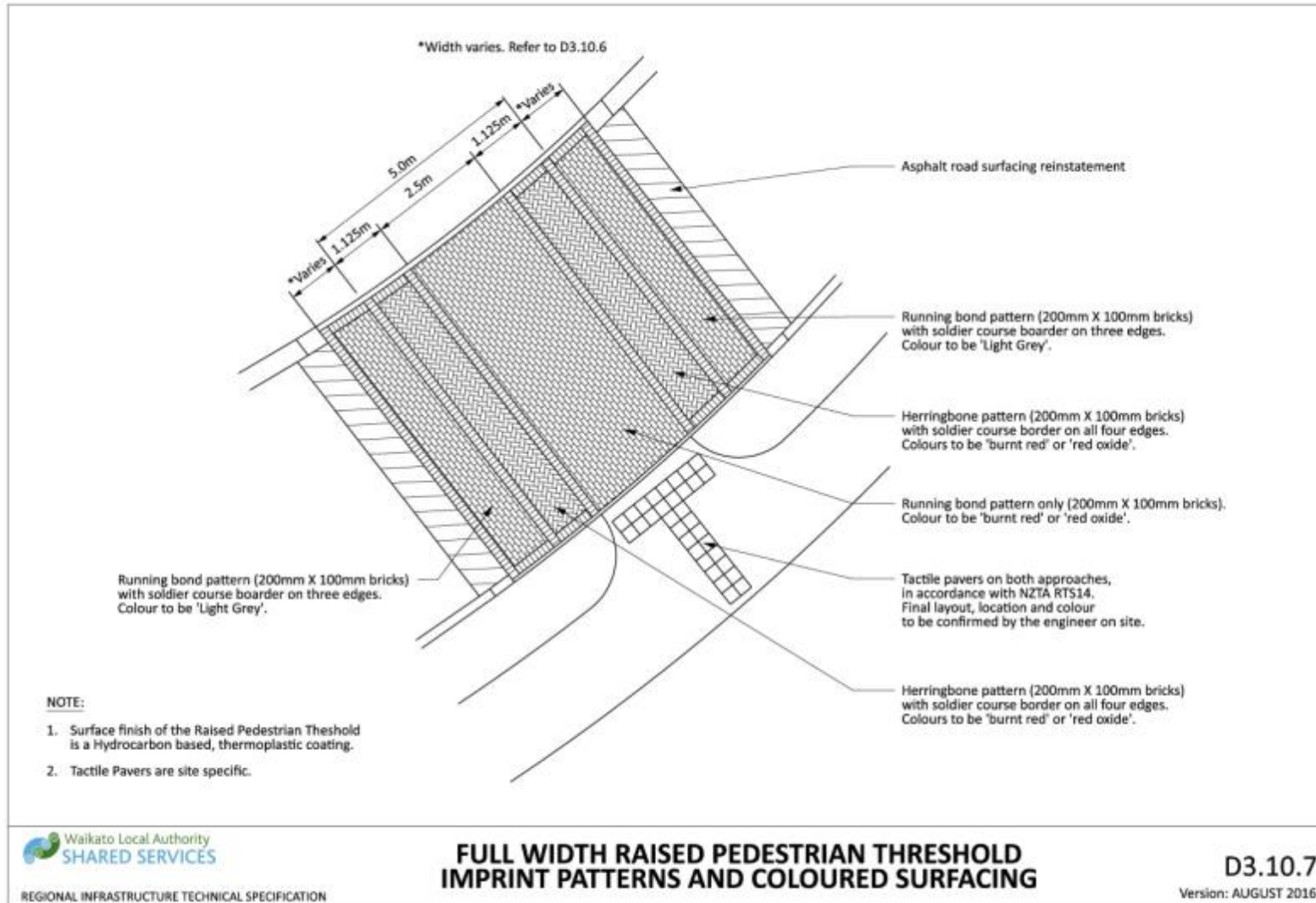

Drawing 3-66: Full width raised pedestrian threshold imprint patterns and coloured surfaces

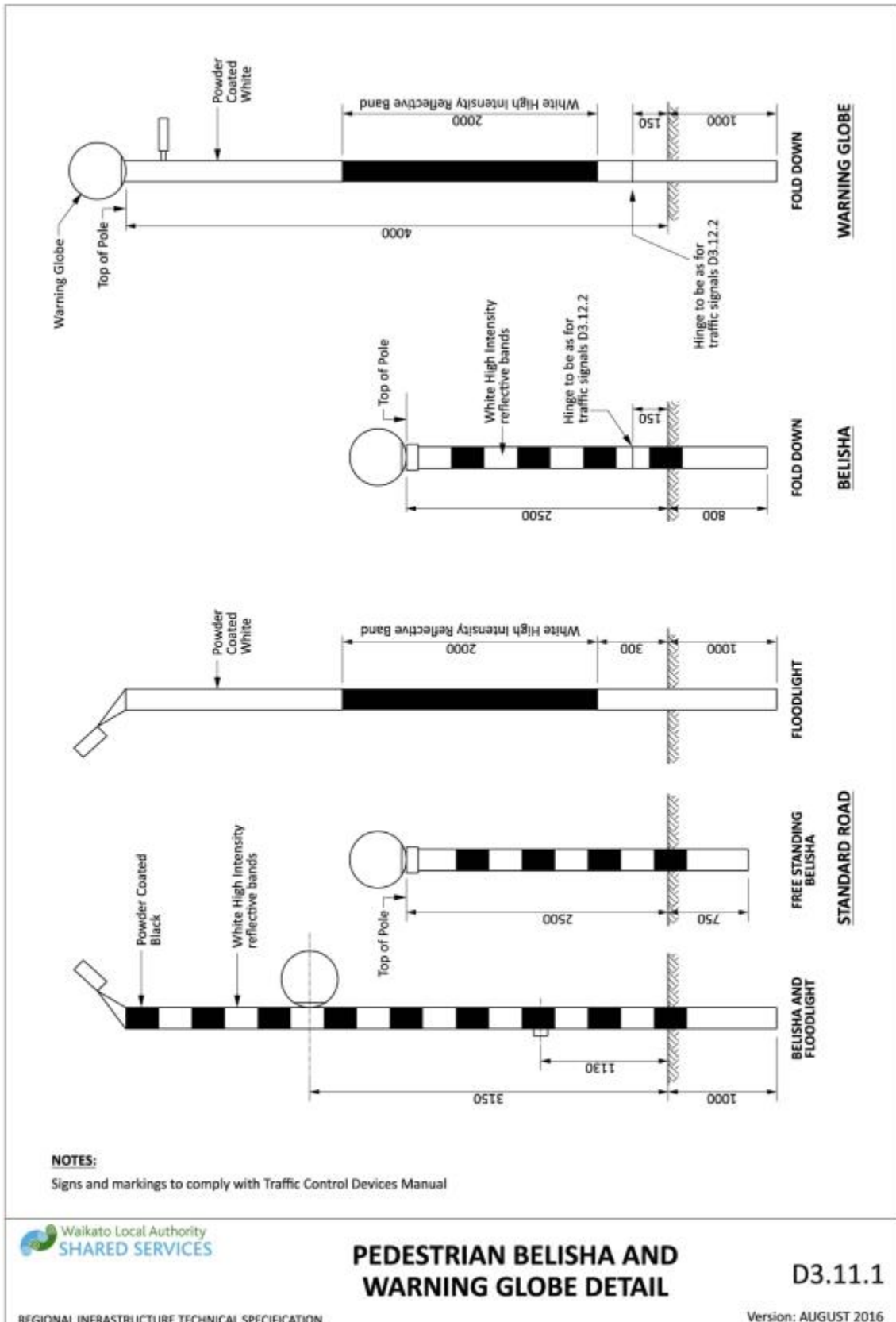

Drawing 3-67: Pedestrian belisha and warning globe detail

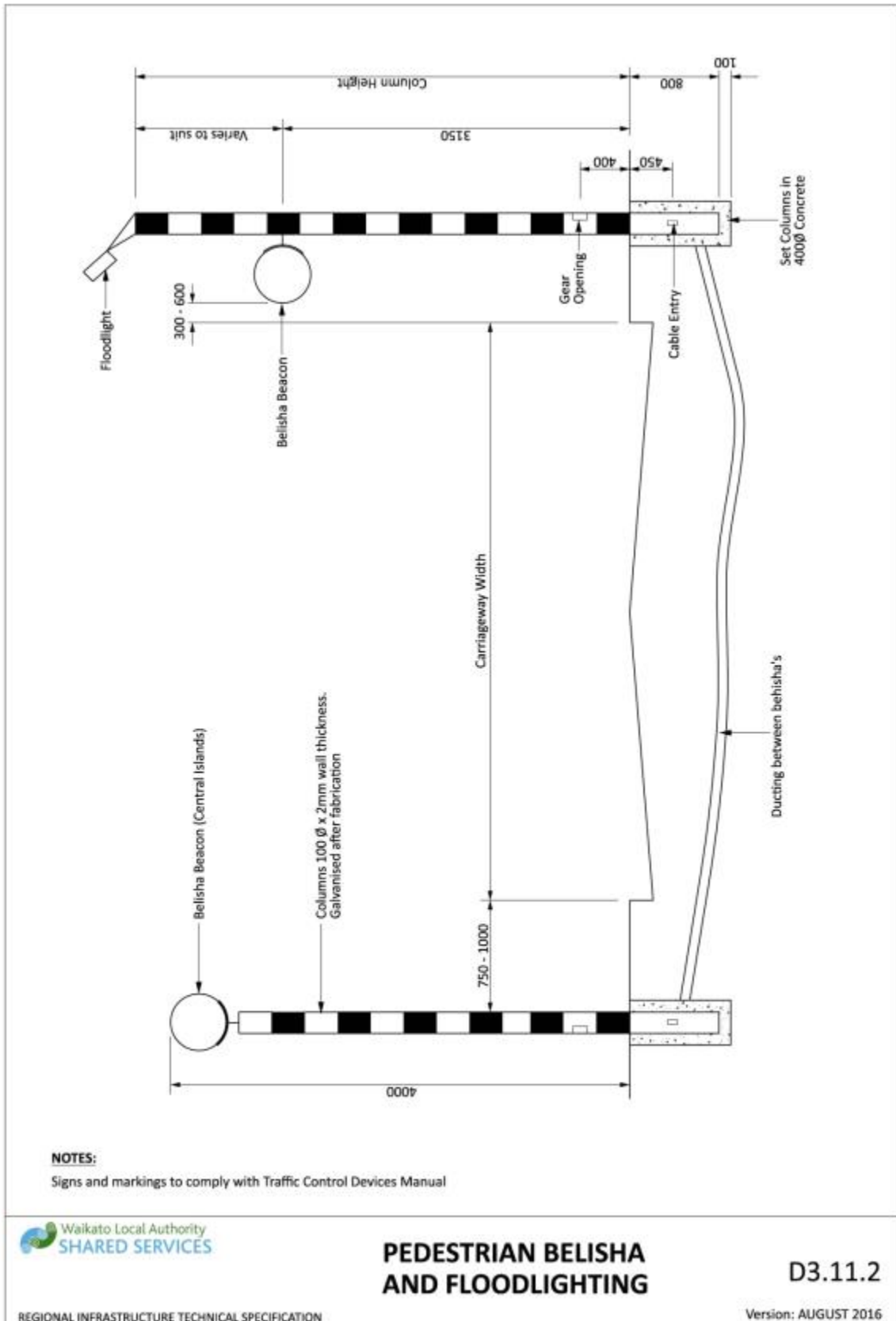

Drawing 3-68: Pedestrian belisha and floodlighting

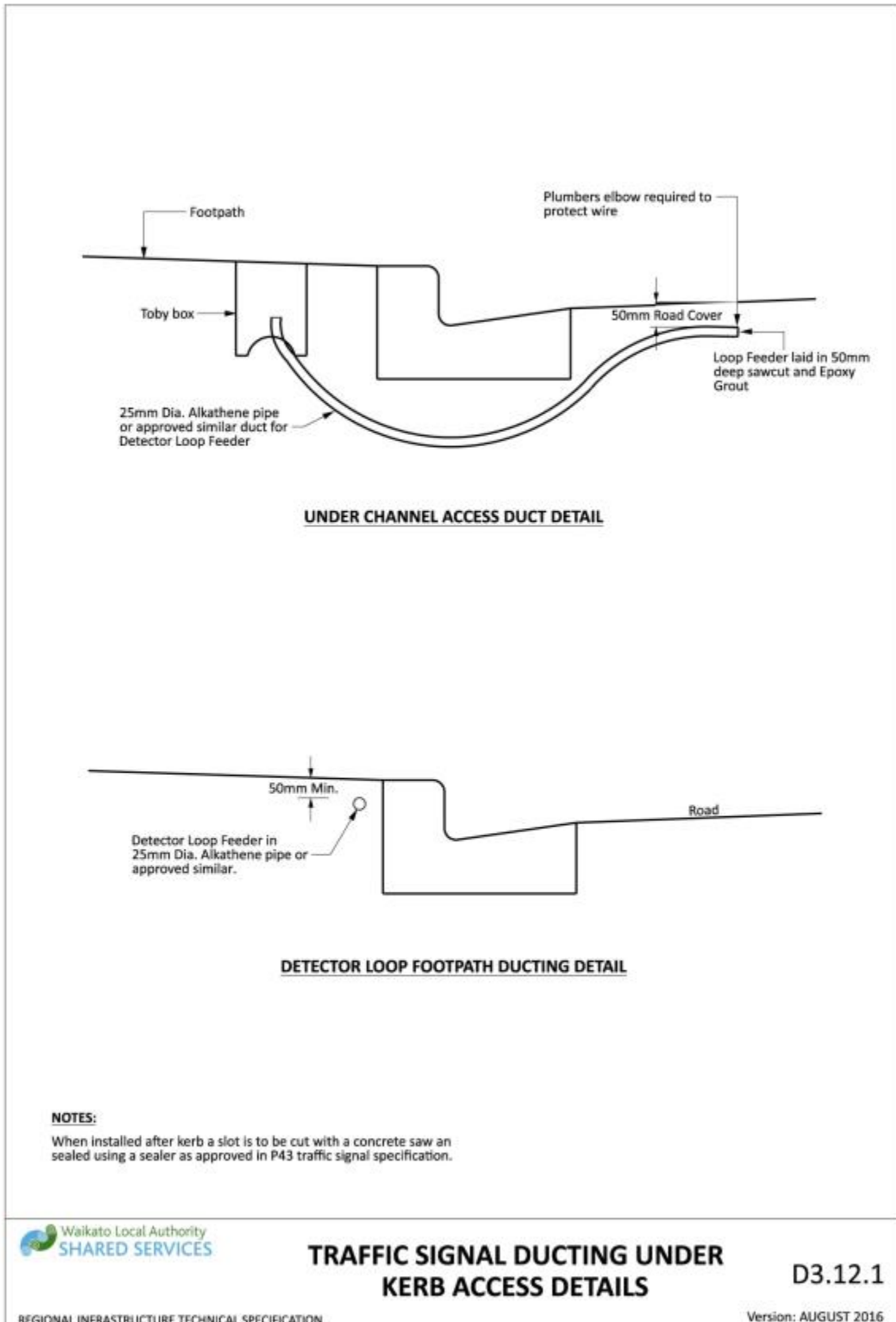

Drawing 3-69: Traffic signal ducting under kerb access details

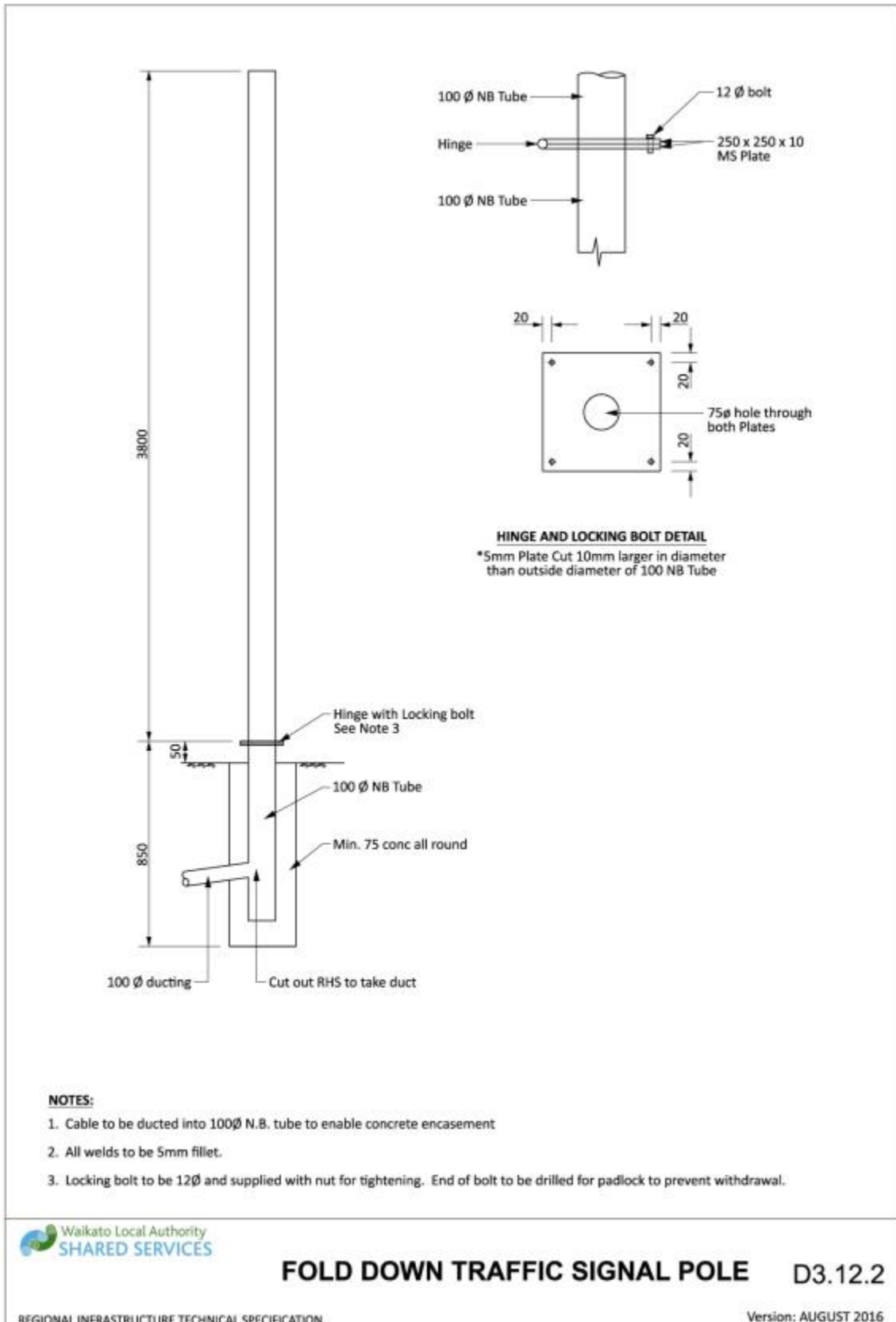

Drawing 3-70: Fold down traffic signal pole

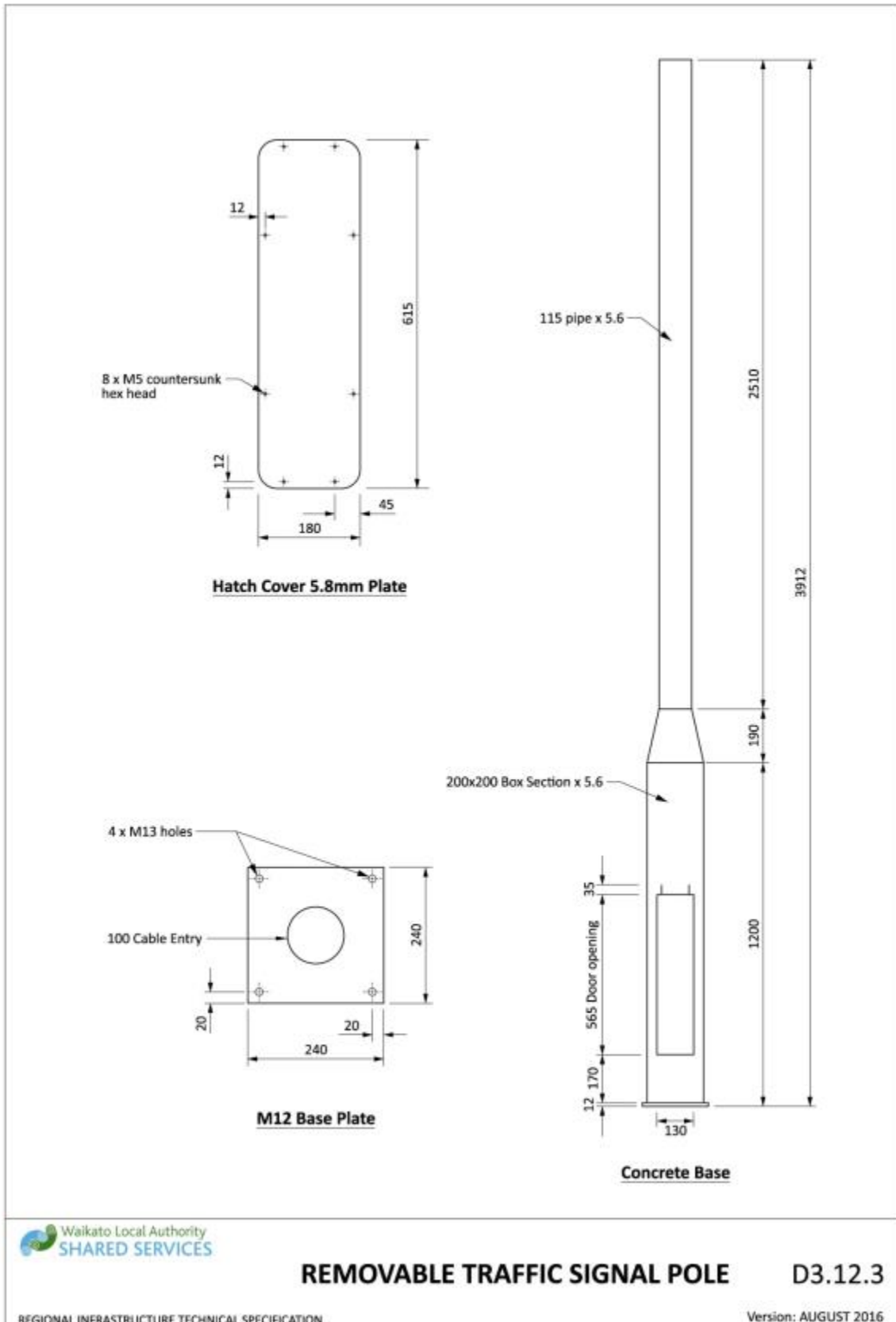

Drawing 3-71: Removable traffic signal pole

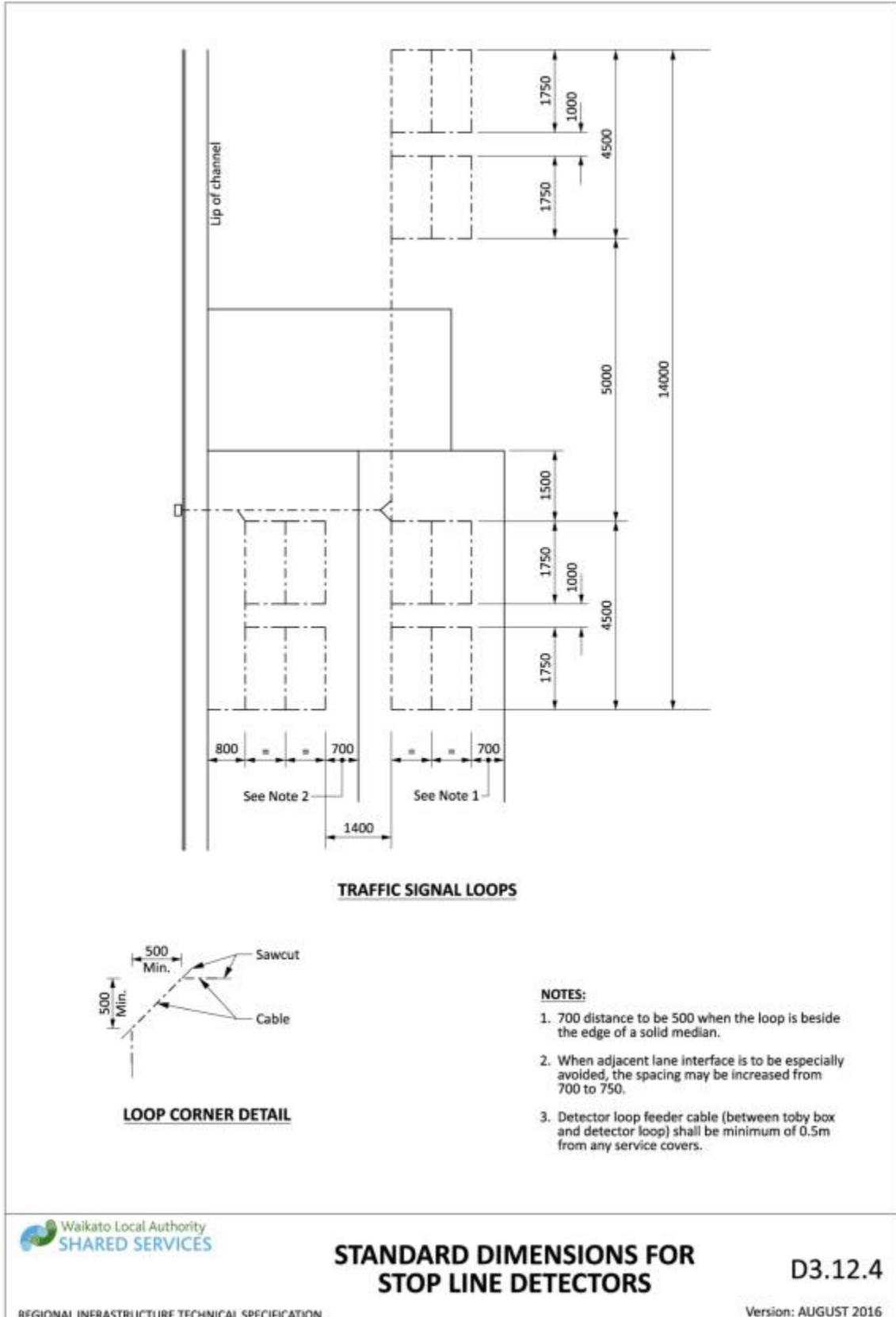

Drawing 3-72: Standard dimensions for stop line detectors

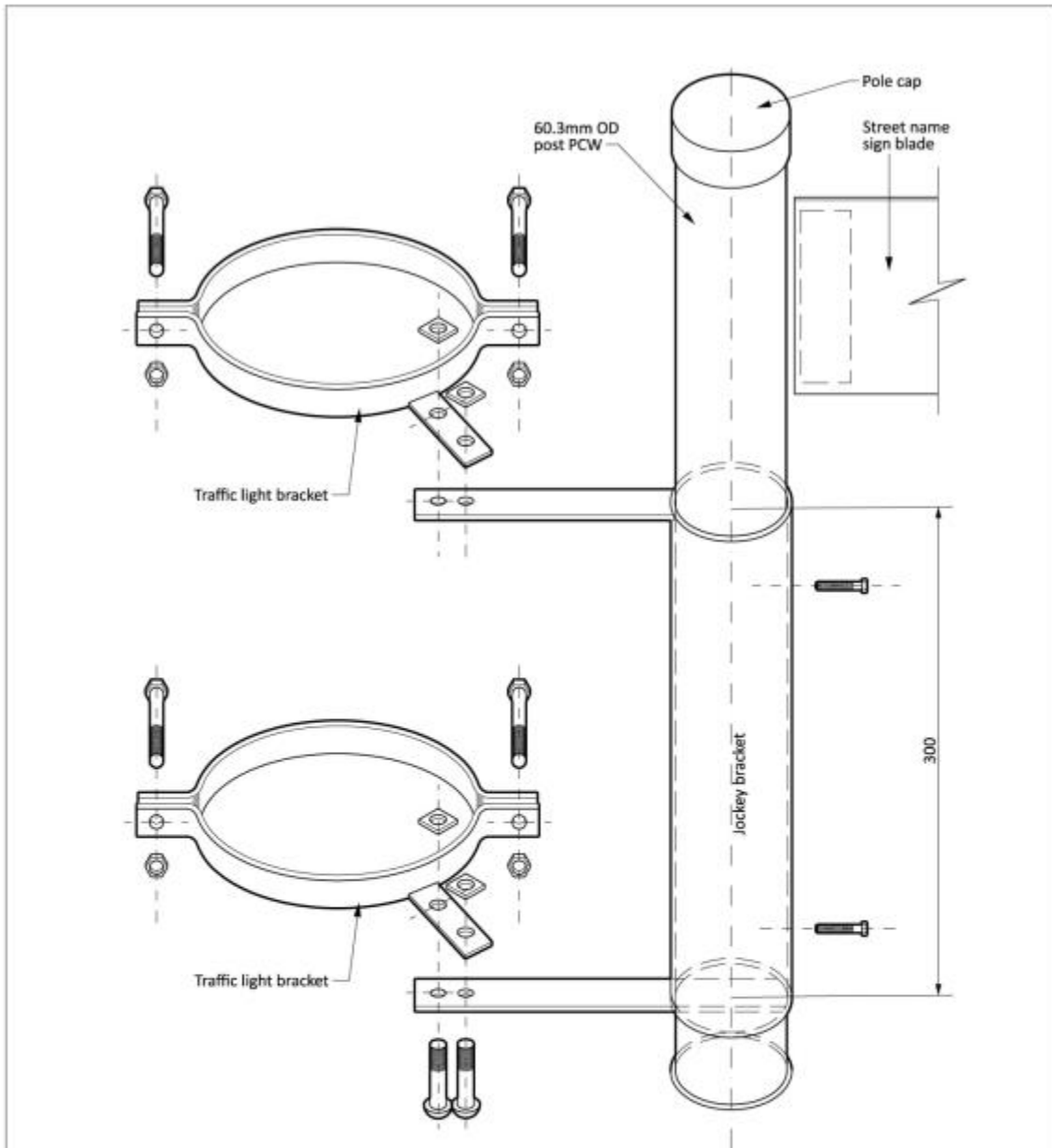

TRAFFIC LIGHT JOCKEY POST

- Scheduled items. 3.1: Jockey bracket x 1
 3.2: Traffic light bracket x 2
 3.3: 60.3 OD post x 1500mm

NOTE:
 All brackets, bolts and washers to be hot dipped galvanised after manufacture.
 Brackets to be 20 x 5 mild steel. All bolts to be M10 galvanised steel.



STREET NAME SIGNS AT SIGNALISED INTERSECTIONS

D3.12.6

REGIONAL INFRASTRUCTURE TECHNICAL SPECIFICATION

Version: AUGUST 2016

Drawing 3-73: Street name signs at signalised intersections

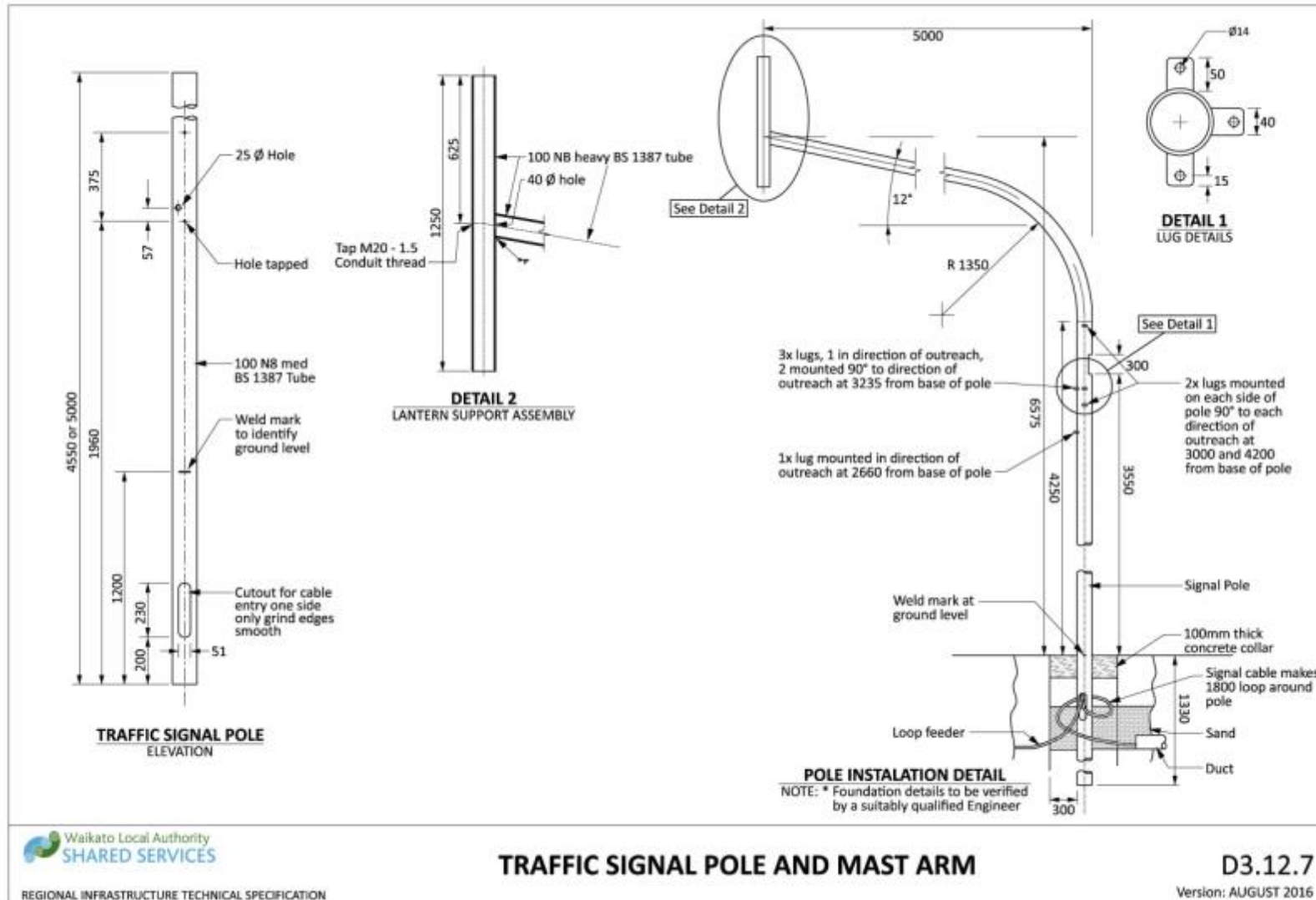

Drawing 3-74: Traffic signal pole and mast arm

APPENDIX D: HAMILTON CITY SPECIFIC REQUIREMENTS

Hamilton Astronomical Society Observatory, Brymer Rd Rotokauri

Any LED Lighting being installed within a 1km radius of the Observatory is to be low light narrow band luminaires and require specific approval from council prior to installation.

City Heart Paving & Kerb Upgrade Drawings



Cityheart - Hamilton CBD Paving Upgrade Date: 03.04.2013 Drawn: CW



Drawing 3-75: Hamilton city specific requirements - Cityheart

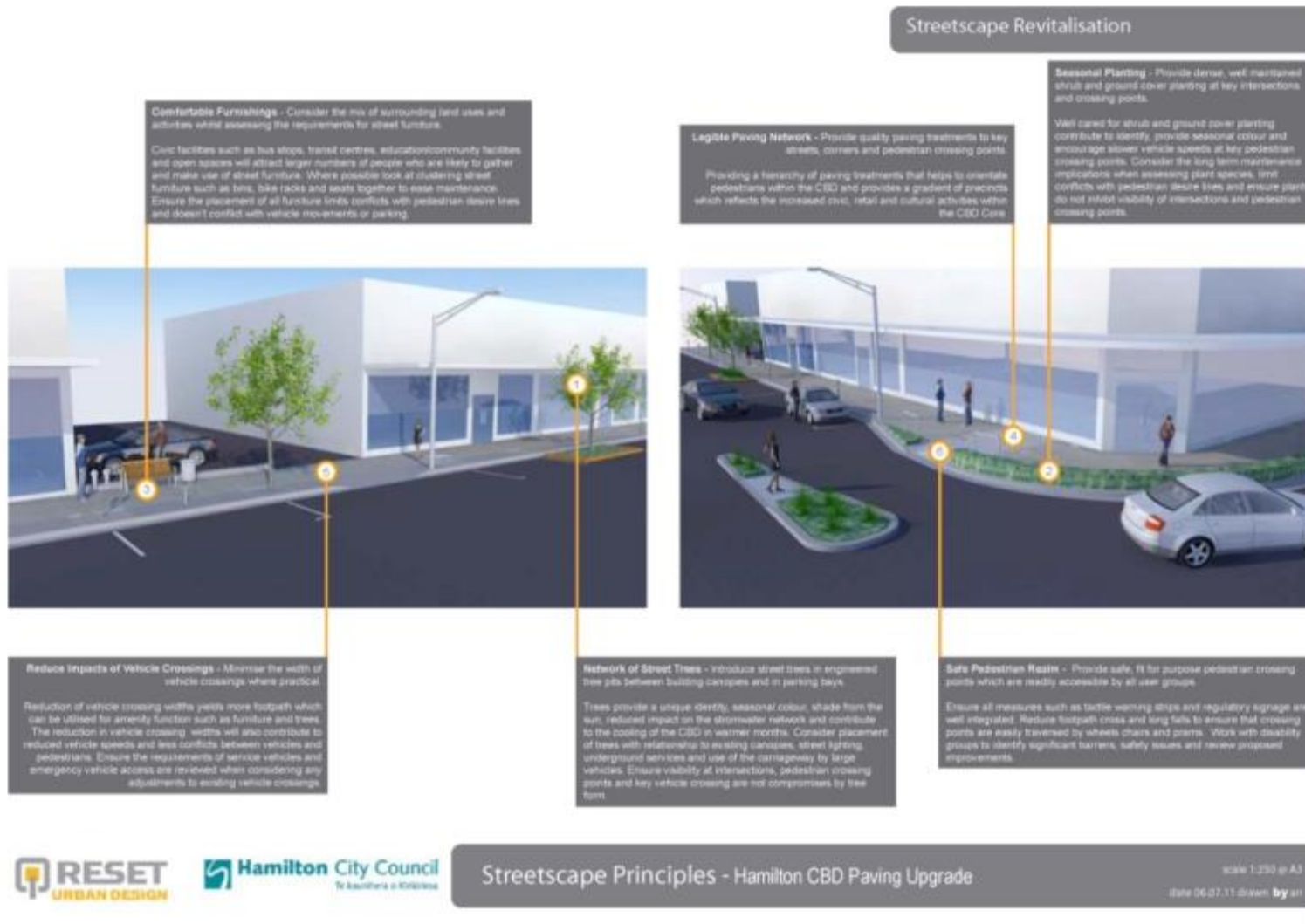

Drawing 3-76: Hamilton city specific requirements - streetscape revitalisation

Street Furniture & Planting Strategy



- KEY:
- CBD Core
 - Main Street
 - CBD Fringe
 - Ward Street West Precinct
 - Shared Space
 - Hood Street Precinct



Strategy - Hamilton CBD Paving Upgrade

scale 1:1000 @ A3
date 06.07.11 drawn by an

Drawing 3-77: Hamilton city specific requirements – street furniture and planting strategy

Street Furniture & Planting Strategy

		STREET FURNITURE			PAVING										TREES				
		BINS	SEATS	BIKE RACKS											TREE PIT LOCATIONS		TREE SPECIES		
		Bins at Sideline Locations	Seats at Bus Stops	Seats at Selected Busstops, Trains and Corners	Bike Racks at Selected Busstops, Trains and Corners	P1 - 50mm Mastic Clay Paving Profile Pavedoz?	P2 - 50mm Mastic Clay Paving - Profile Chaser	P3 - 50mm Mastic Clay Paving - Profile Sandblast?	P4 - 50mm Mastic Clay Paving - Profile Chaser	P5 - Black Hammered 400 x 200 CityHeat Tiles with 2% Concrete Pave	P6 - Exposed Aggregate Inset Concrete Pave (10mm 'Marble' Pebbles with 2% Black Grit)	P7 - Acid Dined Inset Concrete with 4% Black Grit	P8 - Aquaflex Pave Paving 6-10mm 'Grey Pebble'	P9 - M115 Asphalt	Tree Pit in Footpath	Tree Pit in Parking Bay	T1 - Tulp Tree - Umbelacton Substrat	T2 - Kowhai - Saphora Monophylla	T3 - Upright horebeem - Ciparea Fastigata
MAINSTREET	VICTORIA STREET	✓	✓	✓	✓	✓	✓	✓	✓	✓	✓	✓	✓	✓	✓	✓	✓	✓	
CBD CORE	ALEXANDRA STREET	✓		✓	✓			✓	✓	✓	✓	✓	✓	✓	✓	✓	✓	✓	
	BRYCE STREET	✓		✓	✓			✓	✓	✓	✓	✓	✓	✓	✓	✓	✓	✓	
	BARTON STREET	✓		✓	✓			✓	✓	✓	✓	✓	✓	✓	✓	✓	✓	✓	
	WARD STREET	✓		✓	✓			✓	✓	✓	✓	✓	✓	✓	✓	✓	✓	✓	
	CARO STREET	✓	✓					✓	✓	✓	✓	✓	✓	✓	✓	✓	✓	✓	
	HOOD STREET	✓		✓	✓			✓	✓	✓	✓	✓	✓	✓	✓	✓	✓	✓	
	LONDON STREET	✓	✓					✓	✓	✓	✓	✓	✓	✓	✓	✓	✓	✓	
	CLAUDELANDS ROAD	✓	✓					✓	✓	✓	✓	✓	✓	✓	✓	✓	✓	✓	
	GRANTHAM STREET	✓	✓					✓	✓	✓	✓	✓	✓	✓	✓	✓	✓	✓	
	COLLINGWOOD STREET	✓		✓	✓			✓	✓	✓	✓	✓	✓	✓	✓	✓	✓	✓	
CBD FRINGE	MAIN BURTTON PLACE	✓						✓	✓	✓	✓	✓	✓	✓	✓	✓	✓	✓	
	ALBA STREET	✓						✓	✓	✓	✓	✓	✓	✓	✓	✓	✓	✓	
	BRYCE STREET (OVER LIND)	✓						✓	✓	✓	✓	✓	✓	✓	✓	✓	✓	✓	
	BRYCE STREET (WEST)	✓	✓					✓	✓	✓	✓	✓	✓	✓	✓	✓	✓	✓	
	ANGLER STREET	✓	✓					✓	✓	✓	✓	✓	✓	✓	✓	✓	✓	✓	
	WARD STREET (WEST)	✓	✓					✓	✓	✓	✓	✓	✓	✓	✓	✓	✓	✓	
LONDON STREET (EAST)	✓						✓	✓	✓	✓	✓	✓	✓	✓	✓	✓	✓		

Furniture Note: Final furniture locations are to be confirmed on site and assessed based on general amenity level, pedestrian flow, provision of shade and adjacent property usage.

Tree Note: Final tree locations are to be confirmed on site and conform to the HCC development manual specifications. Service locations should also be considered.



Strategy - Hamilton CBD Paving Upgrade

scale 1:1000 @ A3
date 06.07.11 drawn by am

Drawing 3-78: Hamilton city specific requirements - street furniture and planting strategy

Street Furniture Examples:



Bike Racks:
Street Furniture New Zealand
Type 'C' Cycle Rack
316 Stainless Steel with Bead Blasted Finish



Litter Bin:
Fel Group
'Mayfair' Litter Bin
316 Stainless Steel Frame & HDG Steel Wrap with Powder Coat Finish. Colour to be RAL 7012 Basalt grey



Litter Bin 2: CBD Fringe only
Fel Group
'Mayfair' Litter Bin
316 Stainless Steel Wrap & HDG Steel Frame with Powder Coat Finish. Colour to Match



Barrier:
Custom Pedestrian Barrier
316 Stainless Steel with Bead Blasted Finish



Seat:
Fel Group
Santa & Cole Bilateral Seat
HDG Steel frame with Powder Coat Finish. Colour to be RAL 7012 Basalt Grey.
Timber to be Eucalyptus Saligna

Wheel Stop:
Custom Timber Wheel Stop Eucalyptus Saligna with Machine Gauged Finish



Bollard:
Street Furniture New Zealand
'Viaduct' Bollard
316 Stainless Steel with Bead Blasted Finish



P5 - Bush
Hammered 400 x 200 CityHeart 'Volcanic Ash' Concrete Paver



P6 - Exposed Aggregate
Insitu Concrete Firth 10mm 'Manorfield' Pebble with 2% Black Oxide



P7 - Acid Etched
Insitu Concrete with 4% Black Oxide



P8 - Aquaflo
Porous Paving 6-10mm 'Grey Pebble'



P9 - Mix10
Asphalt



Soft Landscape Examples:



Street Tree:
CBD Fringe
Upright Hornbeam - Carpinus Fastigata



Street Tree:
CBD Core
Kowhai - Sophora Microphylla



Street Tree:
Main Street
Tulip Tree - Liriodendron Tulpifera



Mixed Shrub Planting:
Species to be Advised

Paving Treatment Examples:





P1 - 50mm Nubrick Clay Paving
'Profile Pinewood'



P2 and P4 - 50mm and 60mm Nubrick Clay Paving
'Profile Cream'



P3 - 50mm Nubrick Clay Paving
'Profile Sandalwood'





Materials Palette - Hamilton CBD Paving Upgrade

scale NA
date 09.07.11 drawn by an

Drawing 3-79: Hamilton city specific requirements - soft landscape examples

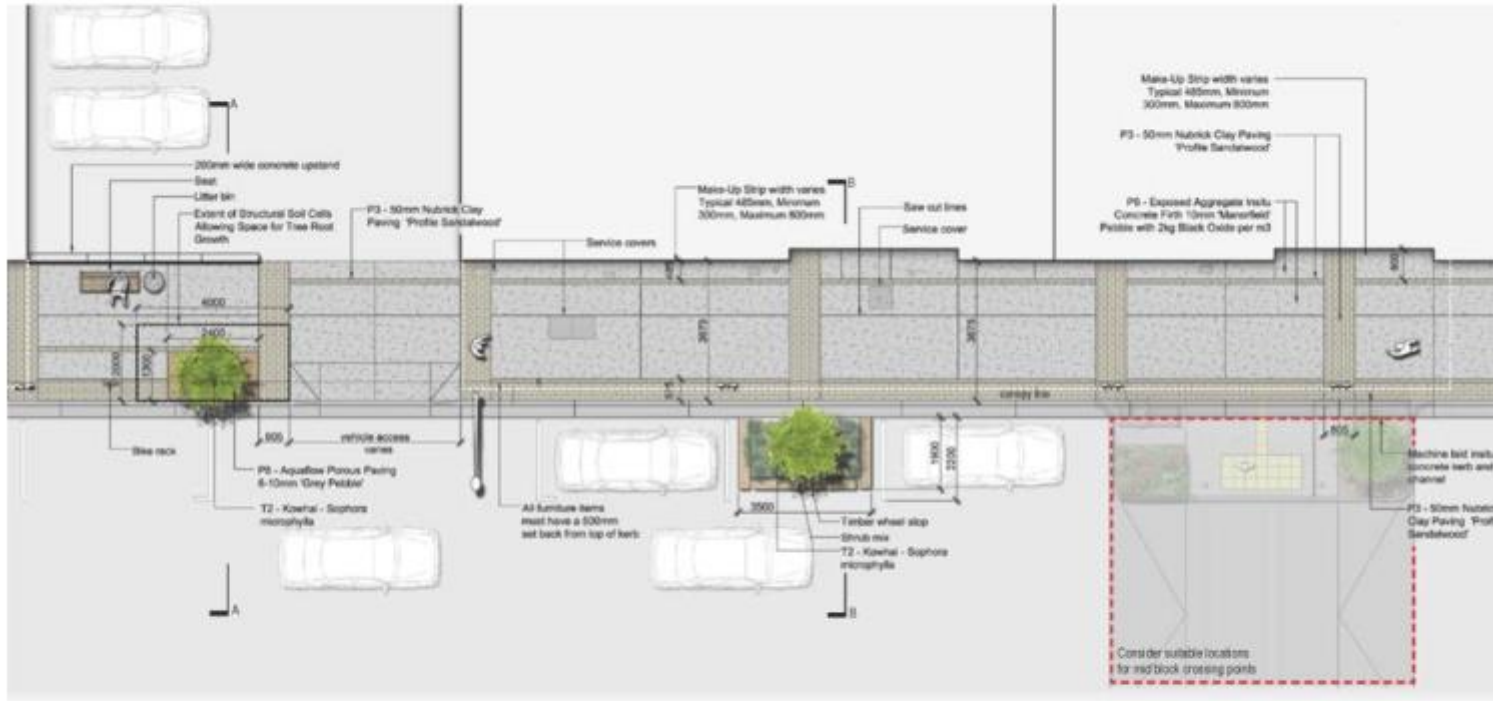
CBD Core Paving Treatment



Typical Treatment - Hamilton CBD Paving Upgrade

scale 1:100@A3
date 05.07.11 drawn by an

Drawing 3-80: Hamilton city specific requirements –CBD core paving treatment

CBD Core Paving Treatment at Corners

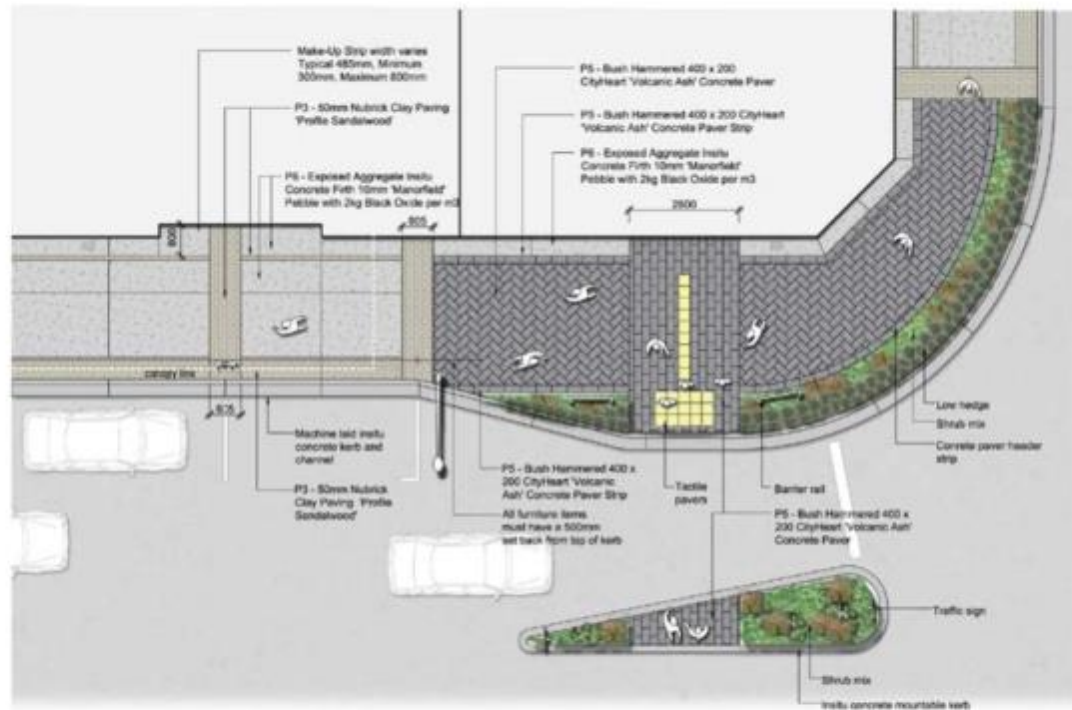

Typical Treatment - Hamilton CBD Paving Upgrade

scale 1:100@A3
date 06.07.11 drawn by an

Drawing 3-81: Hamilton city specific requirements - CBD core paving treatment at corners

Main Street Paving Treatment



Typical Treatment - Hamilton CBD Paving Upgrade

scale 1:100 @ A1
date 05.07.11 drawn by an

Drawing 3-82: Hamilton city specific requirements - main street paving treatment

Main Street Paving Treatment at Corners



Typical Treatment - Hamilton CBD Paving Upgrade

scale 1:100(A3)
date 06.07.11 drawn by an

Drawing 3-83: Hamilton city specific requirements - main street paving treatment at corners

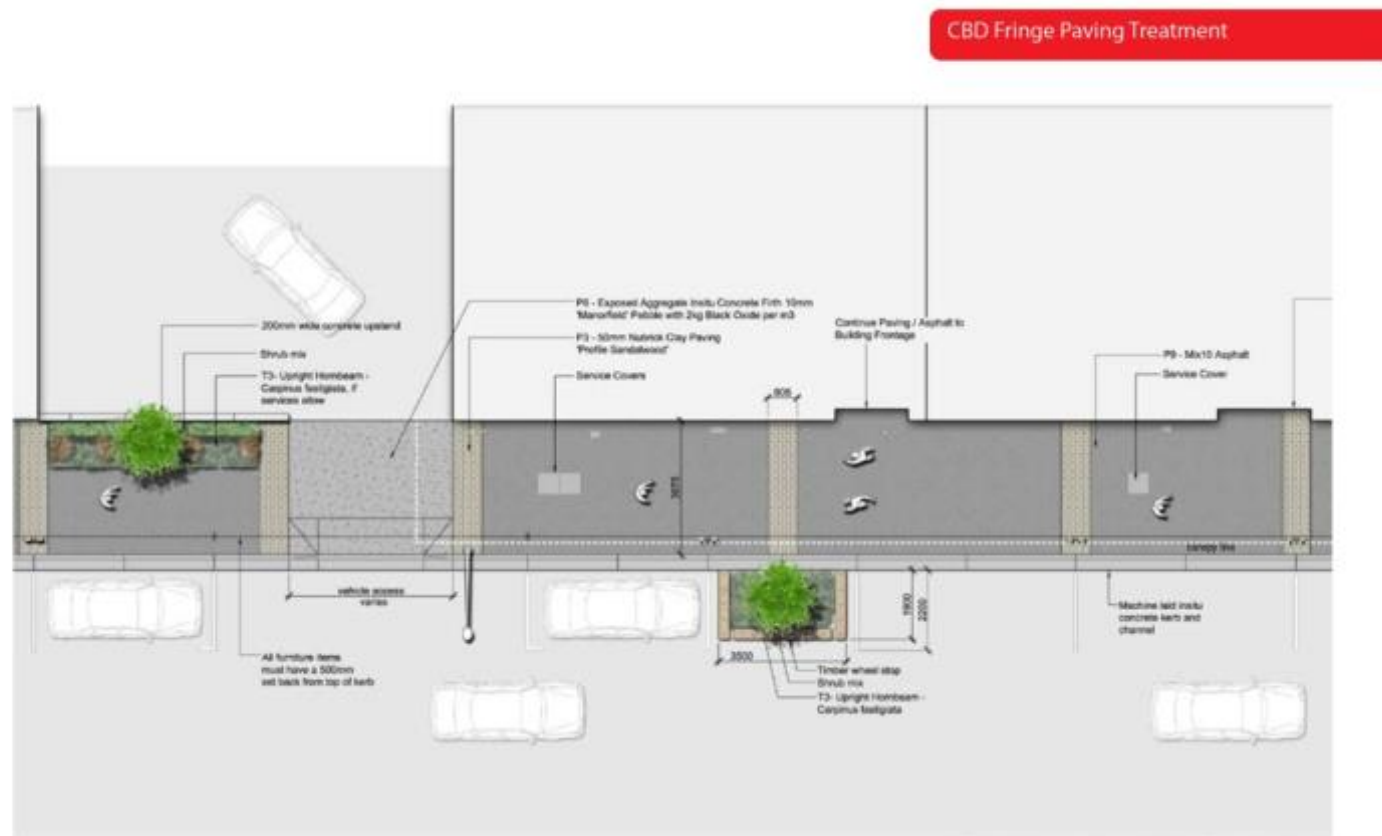

Typical Treatment - Hamilton CBD Paving Upgrade

Scale 1:100@A3
Date 06.07.11 drawn by en

10

Drawing 3-84: Hamilton city specific requirements – CBD fringe paving treatment

CBD Fringe Paving Treatment at Corners

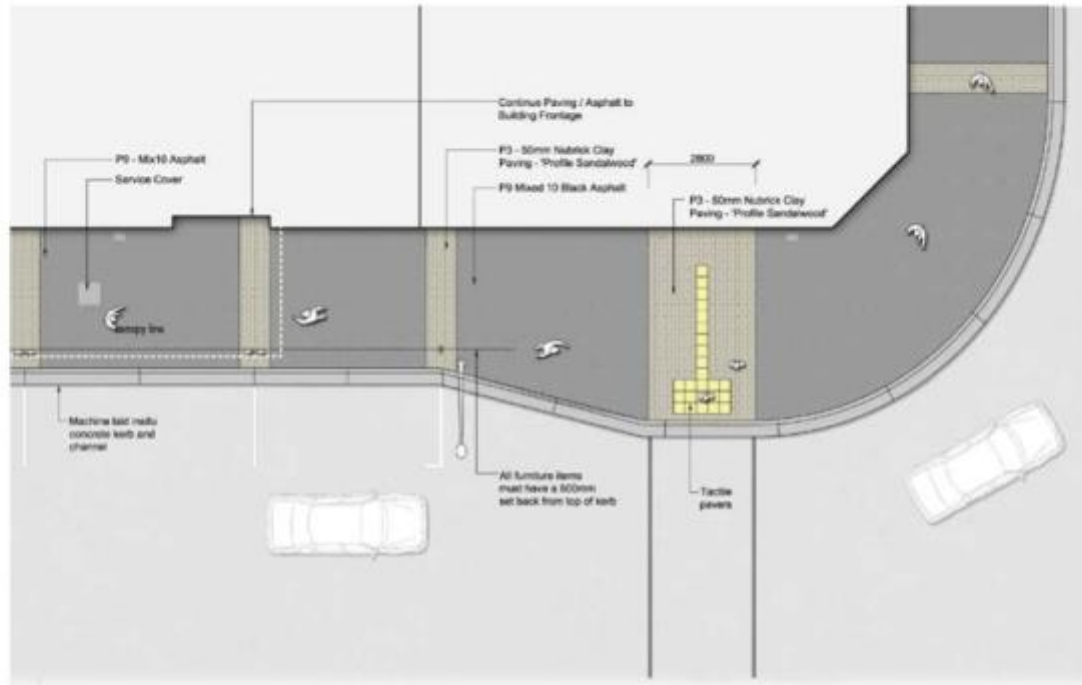

Typical Treatment - Hamilton CBD Paving Upgrade

scale 1:100@A3
date 08.07.11 drawn by an

11

Drawing 3-85: Hamilton city specific requirements - CBD fringe paving treatment at corners

Mid Block Speed Table Crossing Point

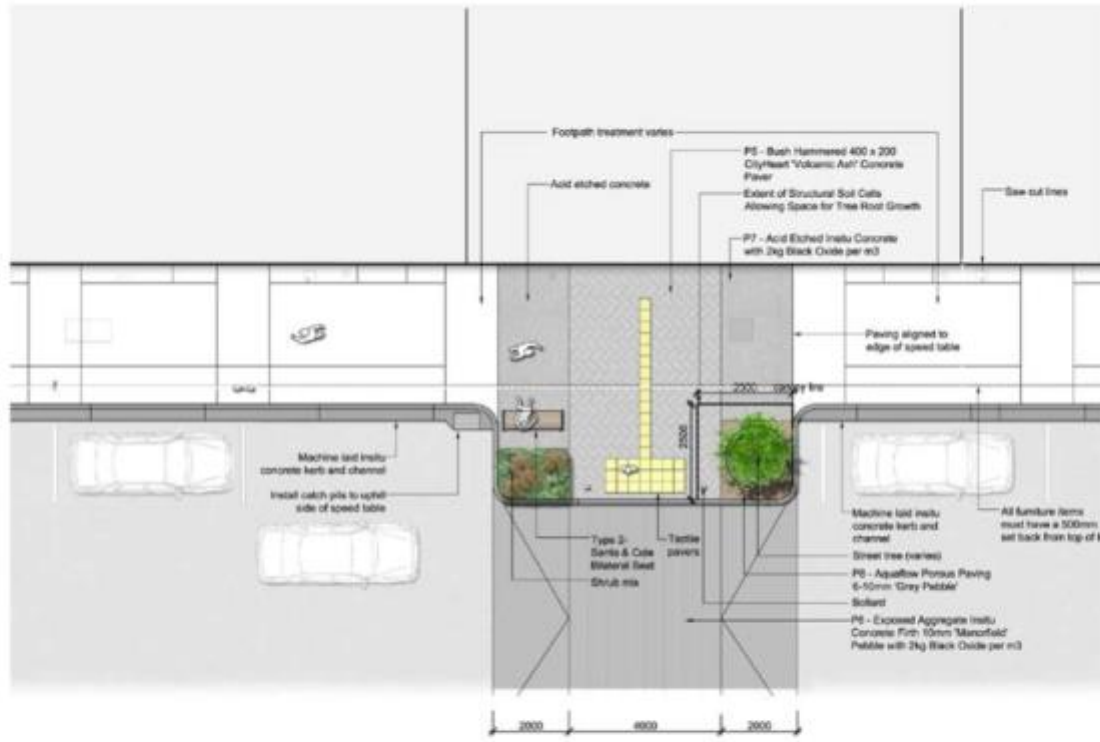

Typical Treatment - Hamilton CBD Paving Upgrade

scale 1:100@A3
date 08.07.11 drawn by an

12

Drawing 3-86: Hamilton city specific requirements - Mid block speed table crossing point



Typical Treatment - Hamilton CBD Paving Upgrade

scale 1:25@A3
date 06.07.11 drawn by an

13

Drawing 3-87: Hamilton city specific requirements - Section A: Typical footpath section - retail edge

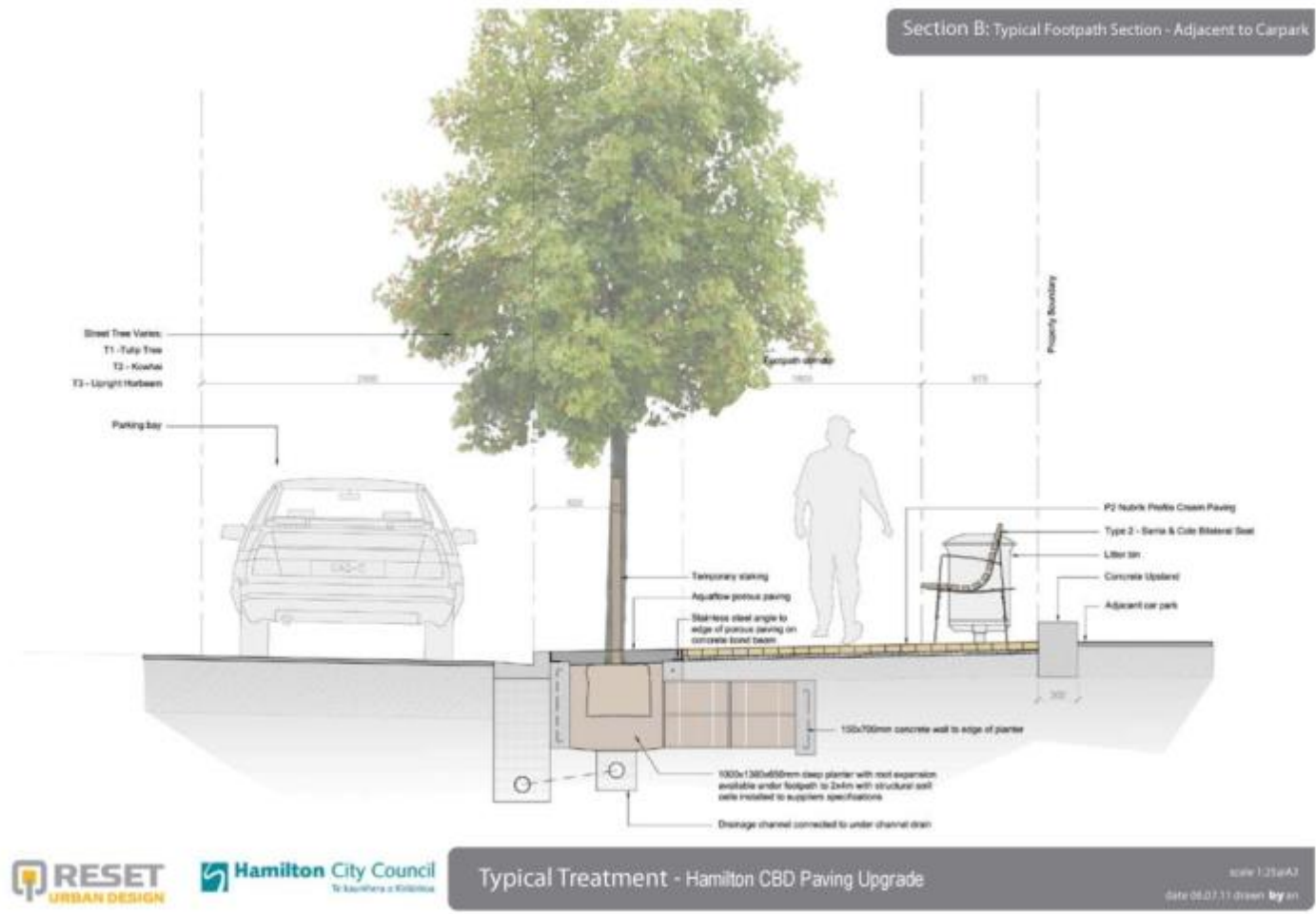

Drawing 3-88: Hamilton city specific requirements - Section B: Typical footpath section - adjacent to carpark

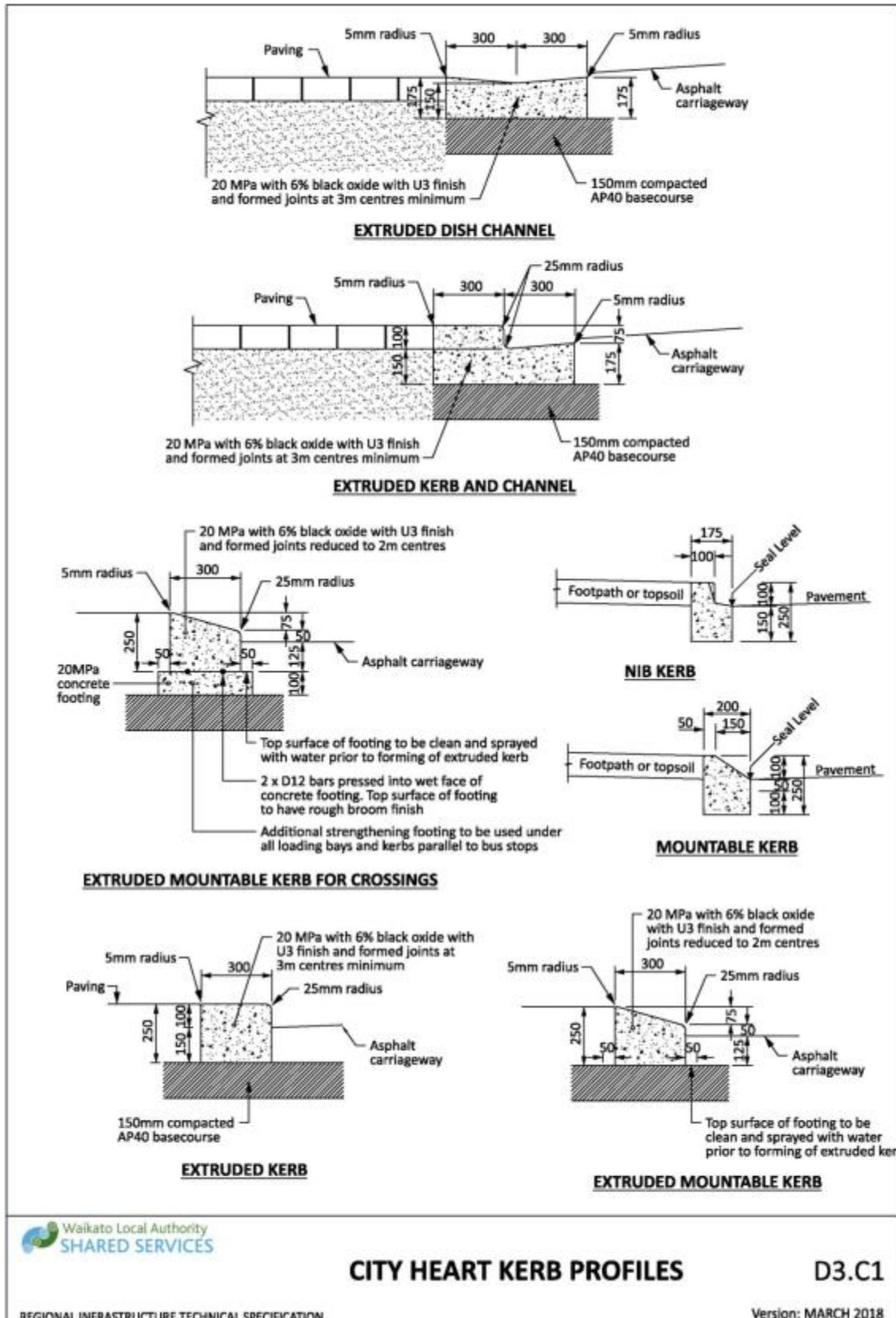

Drawing 3-89: Hamilton city specific requirements - City heart kerb profiles

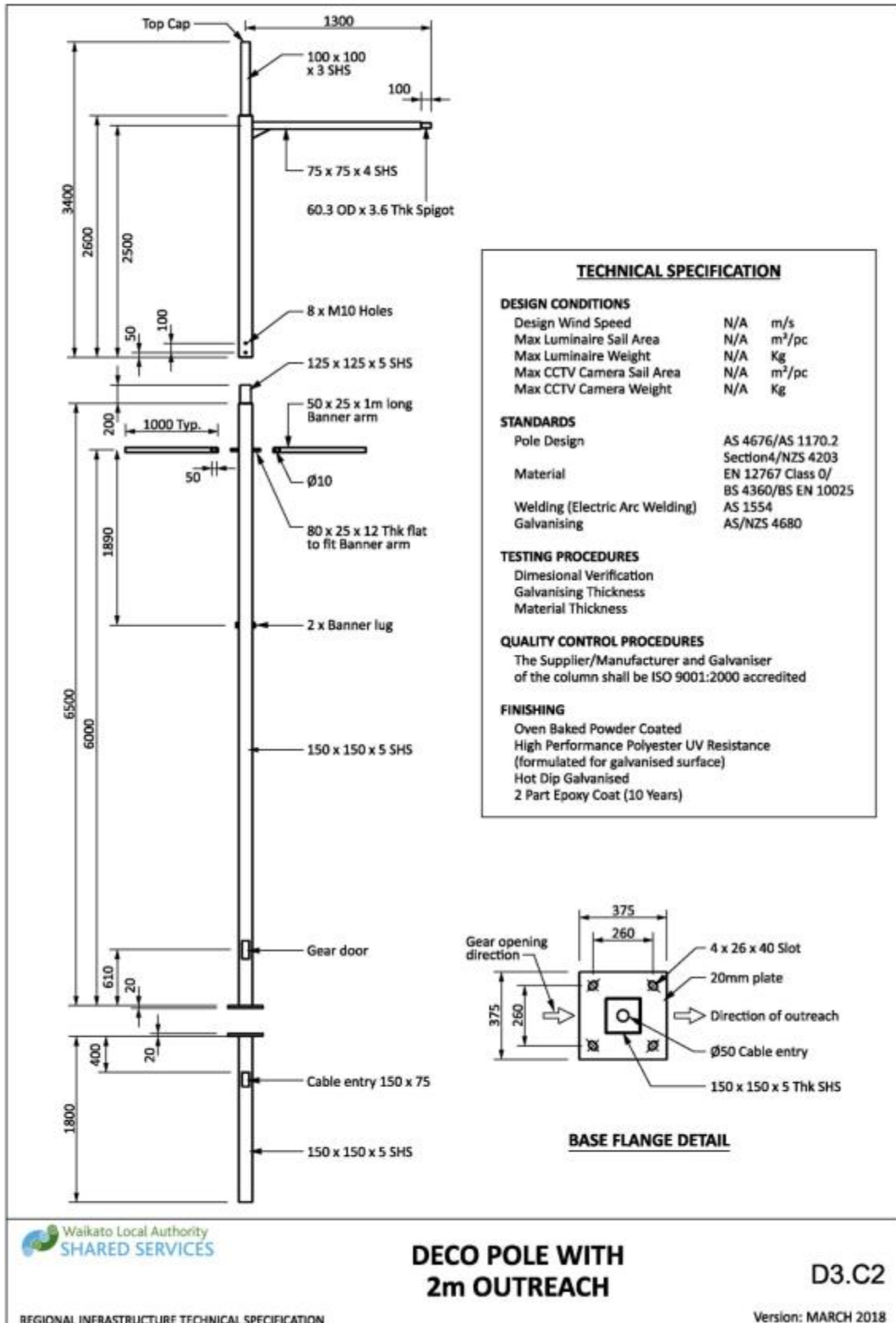

Drawing 3-90: Hamilton city specific requirements - Deco pole with 2m outreach

APPENDIX E - SOUTH WAIKATO SPECIAL CHARACTER AREAS

Litter Bins

South Waikato District Council have different requirements in each of the main town areas as follows:

- Tirau – St Louis Colonial bins, permanent green colour
- Putaruru – Parade Litter Bins, blue lids grey exterior
- Tokoroa – Tokoroa Special bins, orange colour

All of the above bins are supplied by Fel. Group Ltd.

APPENDIX F – WAIPA DISTRICT COUNCIL

Street name blades within Te Awamutu town are to have a green background. All other signage in Waipa DC is to be standard blue background.

4 STORMWATER

4.1	Introduction.....	289
4.1.1	Objectives.....	289
4.1.2	Reference Documents.....	289
4.1.3	Level of Service.....	291
4.1.4	Alteration to Existing Infrastructure.....	292
4.1.5	Waikato Regional Council Resource Consent Requirements.....	292
4.1.6	Stormwater Discharge Consents.....	293
4.1.7	Planning Documents and Assessments.....	293
4.1.8	Catchments and Off-Site Effects.....	293
4.1.9	Discharges.....	293
4.2	Design.....	295
4.2.1	Design Life.....	295
4.2.2	Acceptable Products.....	295
4.2.3	System Design.....	295
4.2.4	Hydraulic Design Criteria.....	303
4.2.5	Watercourses.....	308
4.2.6	Piped System Layout.....	310
4.2.7	Manholes.....	312
4.2.8	Connections.....	314
4.2.9	Building Over or Adjacent to Pipelines.....	316
4.2.10	Catchpits.....	318
4.2.11	Outlets and Inlets.....	319
4.2.12	Culverts.....	321
4.2.13	Weirs.....	323
4.2.14	Subsoil Drains.....	323
4.2.15	Soakage Devices.....	323
4.2.16	Stormwater Treatment Device Selection.....	325
4.2.17	Constructed Wetlands.....	330
4.2.18	Swales.....	342
4.2.19	Raingardens.....	344
4.2.20	Hydrodynamic Separator.....	346
4.2.21	Underground Storage.....	346
4.2.22	Catchpit Filter System.....	347
4.2.23	Underground Chamber Filter.....	347
4.2.24	Planting and Aesthetic requirements.....	348
4.3	Construction and Maintenance.....	352
4.3.1	Pipeline Construction.....	352
4.3.2	Materials.....	352
4.4	Tolerances.....	352
4.4.2	Trenchless Construction.....	353
4.4.3	Joints.....	354
4.4.4	Manholes.....	354

4.4.5 Connections.....	355
4.4.6 Catchpits.....	355
4.4.7 Backfilling and Reinstatement.....	355
4.4.8 Embedment	355
4.4.9 Fill.....	356
4.4.10 Stormwater Treatment and Detention Devices	357
4.5 As-built Information.....	362
4.6 Defects Liability	362
4.6.1 Defects Liability Periods.....	362
4.6.2 Defects Maintenance Requirements	363
4.6.3 Final Defects Inspection Criteria	365
4.7 Acceptance of Proposed Works	367
4.7.1 Stormwater Treatment and Detention Devices.....	367

APPENDICES

Forms and Checklists	369
Drawings.....	383

LIST OF TABLES

Table 4-1: Standards	289
Table 4-2: Related Documents	290
Table 4-3: Minimum Device Design Summary	296
Table 4-4 Landuse categories.....	302
Table 4-5 Receiving environment categories (excluding flood control).....	302
Table 4-6 Treatment train design requirements (excluding flood control)	303
Table 4-7 : Design Level of Service	303
Table 4-8: Runoff Coefficients.....	304
Table 4-9: Runoff Coefficients Refined.....	305
Table 4-10: Loss Coefficients for Bends.....	307
Table 4-11: Minimum Pipe Sizes.....	308
Table 4-12: Pipe Locations	310
Table 4-13: Minimum Clearance from Structures	311
Table 4-14: Culvert design storms	322
Table 4-15: Vested treatment device preferences.....	326
Table 4-16: Location considerations	330
Table 4-17: Wetland design requirements.....	331
Table 4-18: Wetland components to be considered during layout development.....	331
Table 4-19: Terms used for wetland sizing.....	332
Table 4-20: Permanent storage zone design parameters for wetland design	334
Table 4-21: Live storage zone design parameters	335
Table 4-22: Sediment forebay design parameters.....	336
Table 4-23: Wetland inlet design requirements	337
Table 4-24: Wetland outlet design requirements	339
Table 4-25: Wetland spillway design requirements	339
Table 4-26: Maintenance access design requirements	340

Table 4-27: Wetland liner design requirements	341
Table 4-28: Swale design parameters.....	342
Table 4-29: Raingarden design parameters	344
Table 4-30: Hydrodynamic separator specifications	346
Table 4-31: Proprietary underground storage specifications	347
Table 4-32: Catchpit filter specifications.....	347
Table 4-33: Underground Chamber filter specifications.....	347
Table 4-34: Planting Zones	349
Table 4-35: Approved Plant Species.....	351
Table 4-36: Swale Planting - Velocity/Grade Matrix	352
Table 4-37: Approved Mulching	361
Table 4-38: Defects and Liability Periods	362
Table 4-39 : Defects Period Maintenance Schedule.....	363
Table 4-40: Planting Establishment.....	365
Table 4-41: Minimum Inspection Requirements	365
Table 4-42: Forms and Checklists.....	369
Table 4-43: Drawings.....	383

LIST OF FIGURES

Figure 4-1: Overland Flow Graph.....	306
Figure 4-2: Selection of treatment device based on development scenario.....	326
Figure 4-3: Schematic of Typical Offline Kidney Shaped (sinusoidal) Constructed Wetland.....	334
Figure 4-4: Wetland bathymetry diagram	334
Figure 4-5: Typical Wetland Edge Detail	335
Figure 4-6: Typical Wetland Forebay Bund Cross Section	337
Figure 4-7: Stormwater Treatment and Detention Device: Staged Landscape Planting	350
Figure 4-8: Stormwater Devices Transfer Process.....	368

LIST OF DRAWINGS

Drawing 4-1: Private stormwater bubble up pit.....	385
Drawing 4-2: Private stormwater kerb connection	386
Drawing 4-3: Private DN 100 stormwater outlet to minor streams	387
Drawing 4-4: Stormwater secondary flow path treatment - private property	388
Drawing 4-5: Groundwater recharging devices private property	389
Drawing 4-6: Footpath berm catchpit details	390
Drawing 4-7: Catchpit back entry details.....	391
Drawing 4-8: Double sump catchpit design	392
Drawing 4-9: Vertical entry catchpit.....	393
Drawing 4-10: Fish symbols for catchpits.....	394
Drawing 4-11: Swale plan and section	395
Drawing 4-12: Swale driveway crossing detail	396
Drawing 4-13: Rain garden plan and underdrain long section	397
Drawing 4-14: Rain garden detention/soakage cross sections and kerb detail.....	398
Drawing 4-15: Underground storage with approved catchpit filter plan and section.....	399
Drawing 4-16: Underground storage with approved catchpit filter long section.....	400
Drawing 4-17: Underground storage with gross pollutant trap long section	401
Drawing 4-18: Stormwater connections layout	402
Drawing 4-19: DN1050 manholes	403

Drawing 4-20: Typical dimensions for manholes greater than DN1350	404
Drawing 4-21: Shallow manhole/chamber	405
Drawing 4-22: Lateral connection.....	406
Drawing 4-23: Anti-scour blocks for steep drainage pits.....	407
Drawing 4-24: Building over and adjacent to public wastewater or stormwater pipelines ...	408
Drawing 4-25: Wetlands information sign board.....	409

LIST OF EQUATIONS

Equation 4-1: Stormwater energy loss	307
Equation 4-2: Determination of water surface profile.....	308

4.1 INTRODUCTION

This section sets out requirements for the design and construction of stormwater systems for land development and subdivision.

Stormwater systems have the potential to convey pollutants and increase the flow rate and volume of water to a receiving environment such as streams (natural and modified), rivers, lakes and groundwater. Discharges will impact on these environments and the environmental, cultural and social values which they support. The management of stormwater discharges must respond to the pollutant and hydrologic characteristics attributable to the catchment land use and provide treatment to reduce or mitigate adverse impacts.

The RITS provides high level guidance to designers with an understanding of the key design considerations to support good performance outcomes. Further more specific design guidance can be sought from other existing technical resources such as Auckland Council’s TP10⁴.

4.1.1 Objectives

The primary objective of the stormwater system is to manage stormwater runoff to minimise flood damage and adverse effects on the environment. The stormwater system design philosophy aims to protect people, properties and ecological values by preventing or mitigating the quality and the quantity effects of stormwater on the built and natural environment.

The design of the stormwater system shall ensure an acceptable stormwater service for each property by providing a treatment, control and disposal system:

- Within each property boundary, or
- A service connection from each property to a stormwater management system, or
- A combination of the above.

The stormwater system shall meet the minimum design life requirement taking into account structural strength, design loadings, soil conditions and operational and maintenance requirements. The system shall be cost efficient over its design life while accounting for environmental and community impacts through integrated three waters management and water reuse. The stormwater system shall utilise low impact design solutions, and water sensitive techniques to replicate the pre development hydrological regime as far as practical. All existing open streams and channels, gullies and wetlands (perennial and ephemeral) shall remain and be protected or enhanced.

4.1.2 Reference Documents

Documents referenced in this section are as follows:

Table 4-1: Standards

REFERENCE	STANDARD / SPECIFIC CLAUSE
AS 3996:2006	Access Covers and Grates

⁴ This will be replaced by the WRC’s Waikato Stormwater Management Guideline in mid 2018.

REFERENCE	STANDARD / SPECIFIC CLAUSE
AS/NZS 2566	Buried Flexible Pipes
AS/NZS 1252:1996	High strength steel bolts with associated nuts and washers for structural engineering
AS/NZS 1254:2010	PVC-U pipes and fittings for stormwater and surface water applications.
AS/NZS 1260:2009	PVC-U pipes and fittings for drain, waste and vent applications
AS/NZS 2032:2006	Installation of PVC pipe systems
AS/NZS 2033:2008	Installation of polyethylene pipe systems
AS/NZS 2280:2014	Ductile iron pipes and fittings
AS/NZS 2312:2014	Guide to the protection of structural steel against atmospheric corrosion by the use of protective coatings
AS/NZS 2566 Parts 1 & 2	Buried flexible pipelines – Structural design & Installation
AS/NZS 3725:2007	Design for Installation of Buried Concrete Pipes
AS/NZS 4058:2007	Precast concrete pipes (pressure and non-pressure)
AS/NZS 4129:2008	Fittings for polyethylene (PE) pipes for pressure applications
AS/NZS 4130:2009	Polyethylene (PE) pipes for pressure applications
AS/NZS 5065:2005	Polyethylene and polypropylene pipes and fittings for drainage and sewerage applications
BS EN 124:2015	Gully tops and manhole tops for vehicular and pedestrian areas. Design requirements, type testing, marking, quality control.
NZS 3103:1991	Specification for sand for mortars and plasters
NZS 3109:1997	Concrete construction
NZS 3114:1987	Specification for concrete surface finishes
NZS 4404:2010	Land development and subdivision infrastructure
NZS 7643:1979	Code of practice for the installation of unplasticised PVC pipe system

Table 4-2: Related Documents

AUTHOR / ORGANISATION	TITLE
Building Act 2004	
MBIE, 2014	Acceptable Solutions and Verification Methods for NZ Building Code – Clause E1 ‘Surface Water’
Local Government Act 1974	Section 451
Auckland Council	TP10 Design Guideline Manual for Stormwater Treatment Devices, July 2003 ⁵
Auckland Council	TP 124 Low impact design manual for the Auckland Region, 2000
Auckland Council	Technical Report TR2013/018 : Hydraulic Energy Management - inlet and outlet design for treatment devices

⁵ This will be replaced by the WRC’s Waikato Stormwater Management Guideline in mid 2018

AUTHOR / ORGANISATION	TITLE
Auckland Council	Technical Report (TR) on Landscape and ecological values within stormwater management, Aug 2010
Auckland Council	TR2008/020 Application of Low Impact Design to brownfield sites
Australian Government	Australian Rainfall and Runoff Guide – Prject 11 : Blockage of Hydraulic Structures, Feb 2014
Hamilton City Council	Three Waters Management Practice Notes
IPENZ	Guideline and Procedure for Hydrological Design of Urban Stormwater Systems (available on 'Informit.com' website)
Ministry for Primary Industries (MP)	National Plant Pest Accord (NPPA) List
NZTA	SP/M/022 : 2013 - Bridge Manual
NZTA	F2:2013 - Specification for Pipe Subsoil Drain Construction
PVC Pipe Association (Uni-Bell)	Handbook of PVC pipe Design and Construction
Waikato Regional Council	Best Practice Guidelines for Waterway Crossings
Waikato Regional Council	Building a Dam
Waikato Regional Council	Erosion and Sedimentation Guidelines
Waikato Regional Council	Waikato Regional Plan
Waikato Regional Council	Waikato stormwater management guideline ⁶
Waikato Regional Council	Waikato stormwater runoff modelling guideline ⁷
Water New Zealand	NZ Pipe Inspection Manual 3 rd Edition

4.1.3 Level of Service

The design of the system shall be such that the objectives outlined above are met and a stormwater connection can be provided for each lot.

New stormwater systems shall achieve the following minimum standards:

- a) The stormwater system shall operate by gravity. Pumped systems are not acceptable due to ongoing maintenance costs. However, refer to Section 4.2.3.3 for further information.
- b) The primary stormwater system shall be capable of conveying the design storm event (section 4.2.4) without surcharge.
- c) The secondary stormwater system shall be capable of conveying the 100 year ARI storm event within a defined path and without causing undue risk or damage to persons or property.
- d) The stormwater system shall not connect or be able to overflow to the wastewater system.
- e) Development shall not increase peak discharge rates for design events to the receiving waters. However an increase may be acceptable for:

⁶ Be aware that the Guideline may differ to this RITS, but the WRC document prevails

⁷ Be aware that the Guideline may differ to this RITS, but the WRC document prevails

- (i) large events where it is demonstrated that there are no additional adverse effects, which are no more than minor, on the environment or downstream properties as a result of the increase, or
 - (ii) where at source mitigation is not practicable but an offset mitigation is used.
- f) Development shall prevent, or minimise, any increase in discharge volumes to receiving waters to the extent reasonably practicable.
- g) The stormwater system shall provide the required amount of treatment (section 4.2.3).

Where the existing system is affected by the development, any system upgrades shall not increase the flood hazard risk to people or property and no additional private properties shall be affected (i.e. new flood risks shall not extend onto previously unaffected property).

The design parameters and specific requirements for the levels of service listed above differ by land-use type, proposed solution (in the case of treatment and detention) and the catchment. Reference should be made to the following document hierarchy:

- the relevant District Plan;
- any relevant Catchment Management Plan, Stormwater Management Plan, Water Impact Assessment, or similar Council document;
- Auckland Council Technical Publication 10 (TP10 - the adopted design guideline for stormwater treatment)⁸;
- Auckland Council Technical Publication 124 (TP124 – Low impact design)

4.1.4 Alteration to Existing Infrastructure

The connection of a new development to the existing stormwater system shall not negatively affect the minimum level of service.

Alteration of the existing stormwater system to achieve the required level of service and consent compliance shall be at no cost to Council.

4.1.5 Waikato Regional Council Resource Consent Requirements

Resource consents from Waikato Regional Council will be required for all works within the setback distance from any watercourse and any direct 'discharge' to a waterway unless it can be shown to be a permitted activity in the Regional Plan.

Stormwater discharges to the public stormwater system are required to comply with the rules in the Waikato Regional Plan (WRP). If a proposed stormwater discharge cannot meet the permitted activity status of the WRP, regardless of whether or not there is a Comprehensive Stormwater Discharge Consent in place, a resource consent will be required from WRC. This consent can subsequently be transferred and then surrendered under the Comprehensive Stormwater Discharge Consent, if one is in place at the site location.

⁸ This will be replaced by the WRC's Waikato Stormwater Management Guideline in mid 2018

4.1.6 Stormwater Discharge Consents

Individual resource consents from Waikato Regional Council are required for all new stormwater discharges. Once all Council and Waikato Regional Council requirements have been met this consent can be surrendered and the discharge will be managed under Council's Comprehensive Resource Consent.

Council encourages early consultation between the Developer and Council staff to achieve:

- Mutual design outcomes, particularly understanding the site specific and Integrated Catchment Management Plan requirements
- Consistency of discharge activity with requirements of Council's Comprehensive Consents

4.1.7 Planning Documents and Assessments

All design shall be undertaken in accordance with the relevant Council District Plan, Bylaws and Policies. In addition design shall be consistent with national, regional and local statutory planning documents and shall comply with Council's Comprehensive Consent for the discharge of stormwater to land and water.

Where the following documents exist, planning and design of the stormwater system shall be in accordance with the principles and requirements contained within an approved Integrated Catchment Management Plan, Water Impact Assessment and/or Stormwater Management Plan.

Council will advise developers of the existence of the above documents during any culvert discussions regarding development. Design should not occur until the requirements have been confirmed.

The Integrated Catchment Management Plan and Master Plan may contain details of strategic infrastructure to be located within the development area. The responsibility for the design and construction of strategic infrastructure shall be agreed with Council prior to commencing design.

4.1.8 Catchments and Off-Site Effects

All stormwater systems shall provide for the management of stormwater runoff from within the land being developed together with any runoff from upstream catchments.

Upstream flood levels shall not be increased by any downstream development unless the designer demonstrates that any increase will have minor impact on the upstream properties.

The outcome of development shall be that the design of the stormwater system avoids adverse scour, erosion and sediment deposition on land, property and the beds of stormwater receiving water bodies; adverse flooding of land, property and stormwater receiving water bodies; and adverse effects on aquatic ecosystems.

4.1.9 Discharges

Where discharges are outside of the development site, the onsite stormwater management system shall be designed so as to cause no offsite adverse effects. Prior approval shall be obtained in writing from the landowner and any other relevant landholders that may be affected by the proposal.

4.1.9.1 Discharge into a Stream or Watercourse

The uncontrolled discharge of stormwater into streams and watercourses (including artificial ones) is not acceptable. In areas where reuse and soakage are not sufficient, but a stream or watercourse is accessible from the site, the stormwater may be drained to the stream or watercourse provided that the following conditions are met:

- a) Retention/detention and treatment devices shall be proposed, constructed and maintained in accordance with an approved Integrated Catchment Management Plan or Water Impact Assessment. The devices shall be operated and maintained by the Developer to provide best practicable stormwater treatment efficiency at all times until the asset is vested and the defects liability period has ended.
- b) In the absence of an approved Integrated Catchment Management Plan the Developer shall refer to Table 4-7 : Design Level of Service, and contact Council and WRC to discuss what detention and treatment is necessary prior to discharge. A suitable outlet and dissipating structure shall be constructed to ensure no localised erosion of the watercourse occurs. This structure shall be specifically designed to blend in with the immediate natural surroundings.
- c) The direction of the discharge shall be aligned with the natural downstream flow as much as practicable to prevent erosion of the opposite stream bank. In situations where erosion of the opposite bank is unavoidable, appropriate mitigation measures are required.
- d) No obstructions are to be placed in a watercourse that will impede the natural flow unless these are installed as part of an approved stormwater management system.
- e) Individual properties which border onto a stream should discharge their stormwater into the stream in a dispersed manner, via an appropriate vegetated flow dispersal device, to avoid causing erosion.

Overland flow paths shall be provided in accordance with Section 4.2.3.4 to cater for events exceeding the capacity of the primary system and occasions when the primary drainage system fails.

4.1.9.2 Discharge into the Public Stormwater System

Council has no legal obligation to provide any property with a connection to a public stormwater system. Council currently provides a public stormwater system to most urban areas, however in some areas the system may already be at capacity.

As a guideline, after reuse, soakage and surface water outlets have been exhausted, small developments can connect to the public stormwater system where this is within 30m of the property boundary. Where the system is further away, then a kerb outlet solution is allowable (refer Section 4.1.9.4). Developments requiring discharges greater than 300mm diameter will require specific assessment.

Stormwater treatment and detention will be required prior to discharge to the Council's system.

Overland flow paths shall be provided in accordance with Section 4.2.3.4 to cater for events exceeding the capacity of the primary system and occasions when the primary drainage system fails.

4.1.9.3 Discharge to a Council Owned Reserve

In situations where a property borders onto a Council owned reserve and the natural flow of stormwater is in the direction of the reserve, it may be appropriate to discharge stormwater to the reserve provided suitable quantity and quality control is provided, and that this does not adversely affect the amenity value or function of the reserve in any way or create any stability or flooding liability issues for Council. The method of stormwater discharge to a Council owned reserve requires specific approval from the Council's parks staff.

4.1.9.4 Discharge to the Road Kerb

Stormwater discharge to a road kerb as a primary means of disposal is not an acceptable solution for stormwater disposal from new developments in 'Greenfield' areas. The use of kerbed roads as an overland flowpath may be acceptable if it is in accordance with the maximum depth and velocity requirements.

In some areas there is a public stormwater drainage system which serves the road network and some properties currently discharge their stormwater onto the road and ultimately into the road drainage system. This system was generally not designed for the additional stormwater flows and there is no right to utilise the road for primary drainage purposes. As a principle, all sites must minimise discharges of stormwater onto urban roads.

4.2 DESIGN

4.2.1 Design Life

All stormwater systems shall be designed and constructed for an ultimate asset life of at least 100 years. Some components of detention and treatment devices such as wetlands, rain gardens and other systems will require earlier renovation or replacement as part of ensuring long term function. These assets will require an approved operations and maintenance manual which details the ongoing asset management needs.

Where any proposed device is designed with an asset life less than 100 years, this decision shall be justified in design documentation and the asset renewal requirements fully documented in an Operations and Maintenance Plan which shall be provided to Council for acceptance.

4.2.2 Acceptable Products

Refer to the [Acceptable Products Section 8](#).

4.2.3 System Design

Stormwater systems shall be considered as the total system protecting people, land, infrastructure, and the receiving environment. A stormwater system consists of:

- a) A primary system designed to accommodate a specified design rainfall event appropriate for the zone, appropriate treatment of pollutants and ensure the effects from the primary system are managed; and
- b) A secondary system to ensure that the effects of stormwater runoff from events that exceed the capacity of the primary system are managed, including occasions when there are blockages in the primary system.

The stormwater system could include private as well as public infrastructure. While this document generally relates to the design and delivery of public infrastructure, some reference is made to private infrastructure where applicable.

4.2.3.1 Stormwater Management Disposal Hierarchy

Disposal of stormwater from land subject to development must be carefully considered to ensure that the development does not contribute to adverse impacts downstream. These impacts can be flow related (i.e. flooding or scour) or water quality related. The proposed disposal system must therefore respond to downstream conditions, be they natural receiving environments or existing engineered infrastructure. When selecting stormwater management solutions the following hierarchy shall be adopted with regards to disposal.

- a) Retention of rainwater/stormwater for reuse on site
- b) Soakage techniques
- c) Treatment and detention and gradual release to a watercourse
- d) Treatment and detention and gradual release to a piped stormwater system

Stormwater shall be managed as close to the point of origin as possible, in order to minimise collection and conveyance infrastructure.

Table 4-3 provides a summary of the design parameters to address specific stormwater criteria and guidance on when these are required. These criteria and parameters should be applied for all developments unless the approved Integrated Catchment Management Plan, Catchment Management Plan, relevant District Plan or WRP requires different values.

Stormwater management may not be required on ‘low contaminant’ individual lots where an approved centralised downstream device is provided and sized appropriately for the development. However Stormwater Management (Water Efficiency Measures)⁹ will still be required in accordance with the District Plan but the requirement will be a reduced measure. These may include rainwater tanks for reuse, private raingardens, permeable surfaces, pervious paving or other techniques. The Hamilton City Council, Three Waters Management Practice Notes may be referred to for details of the implementation of management solutions on individual lots. The practice notes contain acceptable means of complying with the relevant Council’s District Plan requirements.

The practice notes are available on HCC’s website and can be accessed [here](#).

Table 4-3: Minimum Device Design Summary

CRITERIA	DESIGN PARAMETER	WHEN REQUIRED
Design calculations	Rational method up to 8ha. For catchments greater than 8ha, appropriate hydrological methods shall be confirmed with Council, who will look to the appropriate standards and guidelines	Always.

⁹ Only Hamilton City Council currently has these

CRITERIA	DESIGN PARAMETER	WHEN REQUIRED
Runoff coefficients	Pre-development runoff coefficients shall be based on the existing landuse. Post-development runoff coefficients shall be based on the zoning. Refer Table 4-8: Runoff Coefficients.	Always.
Design Rainfall	Refer to Design Rainfall (section 4.2.4.3 and 4.2.4.4).	Current rainfall (i.e. not climate change adjusted) shall be used for the following: <ul style="list-style-type: none"> sizing temporary works where climate change is not relevant. determining pre-development stormwater runoff flows and volumes for use in combination with calculated post development flows to determine SW treatment (quantity and quality) requirements Climate change adjusted rainfall shall be used for the following: <ul style="list-style-type: none"> Determining post-development stormwater runoff flows and volumes for SW infrastructure design.
Time of concentration	Calculated, with a minimum of 10 minutes. Refer to relevant (or HCC) SW Modelling Methodology.	Always.
Flood Control (100 year ARI event)	Detention required, limiting the post-development 100 year ARI event flow rates to 80% of the pre-development 100 year ARI event flow rates.	Where identified downstream flooding (or risk of) exists. ¹⁰
Flow attenuation ¹¹ (Attenuation of the 2 year and 10 year ARI events)	Match pre-development flow rates for the 2 and 10 year ARI events through controlled attenuation and multi stage outlets or devices that reduce the runoff flow.	Catchment location dependent. Always required in the upper half of the catchment. If the development is located close to the catchment outlet and discharging to a watercourse with sufficient capacity, then flow mitigation may not be required. This may also apply if the site is in the lower half of the catchment, and attenuation might worsen flooding due to relative timing of peaks from the upper catchment.
Volume	Match pre-development volume runoff through reduced runoff practices and sub-catchment management If this cannot be achieved, mitigation within the receiving environment will be required, such as channel stabilisation.	When discharge is into a natural stream or modified channel. (Refer Table 4-5)
Water quality treatment ¹²	Refer to the stormwater management disposal hierarchy (section 4.2.3.1) and	Always.

¹⁰ Refer Flood Hazard Areas in the District Plan, relevant approved Integrated Catchment Management Plan and any known downstream restrictions causing flooding.

¹¹ Retention is encouraged alongside EDV but is generally located on private property

CRITERIA	DESIGN PARAMETER	WHEN REQUIRED
	<p>treatment devices hierarchy (section 4.2.16) for disposal and treatment preferences.</p> <p>Water quality requirements include:</p> <ul style="list-style-type: none"> • Total suspended solids (TSS) (75% removal of post development loads taken as measured at the discharge point from site). • Total Metals (copper, zinc) to achieve maximum practical removal possible. • Temperature (<25°C) • Nutrients (total nitrogen, total phosphorus and ammoniacal nitrogen) to achieve maximum practical removal rates. • Hydrocarbons to achieve maximum practical removal rates • Gross pollutants (litter and commercial waste). 	
Water quality storm	1/3 of 2 year 24-hour ARI rainfall depth with climate change used to calculate water quality volume (WQV)	<p>Always.</p> <p>If extended detention is required to protect natural receiving environments (refer below), half of the calculated WQV can be included within the EDV. Hence the water quality volume provided as permanent water volume can be reduced by 50%.¹³</p>
Extended Detention Volume (EDV)	Extended Detention Volume ¹⁴ (EDV) is assessed using the Water quality storm as above.	When discharge is into a natural stream or modified channel (refer to Table 4-5 Receiving Environment Categories for further definition).
Primary ¹⁵ and Secondary Level of Service	<p>As per Level of Service for the zone – Table 4-7. For secondary flow path design requirements for infill residential development refer to Table 4-7</p> <p>Secondary overflow as per Level of Service Clause 4.1.3.</p>	Always.
Minimum Levels	<p>Floor Freeboard requirements: 100 year ARI event plus minimum freeboard heights as per NZS 4404 Clause 4.3.5.2, as follows:</p> <p>“The minimum freeboard height additional to the computed top water flood level of the 1% AEP design storm should be as follows or as specified in the district or regional plan:</p> <p>Freeboard</p> <ul style="list-style-type: none"> • Habitable dwellings (including attached 	Always.

¹² Unless an alternative criteria is provided within a relevant approved ICMP or WRC Stormwater Consent.

¹³ Refer Section 5.4.1 TP10, replaced by WRC's Waikato Stormwater Management Guideline (mid 2018)

¹⁴ Refer Auckland Council's TP10 for detail of Extended Detention design, replaced by WRC's Waikato Stormwater Management Guideline (mid 2018).

¹⁵ The primary system shall be designed to ensure capacity to accommodate the peak flows, without surcharge - refer Table 4-5

CRITERIA	DESIGN PARAMETER	WHEN REQUIRED
	garages) = 0.5m min height; • Commercial and industrial buildings = 0.3m min height; • Non-habitable residential buildings and detached garages = 0.2m min height. The minimum freeboard shall be measured from the top water level to the building platform level or the underside of the floor joints or underside of the floor slab, whichever is applicable."	

4.2.3.2 Design Considerations

The following needs to be considered and where appropriate included in the design:

- a) Quality and quantity requirements of any discharge
- b) How the roading stormwater design is integrated into the overall stormwater system
- c) The type and class of materials proposed to be used
- d) System layouts and alignments including:
 - (i) Route selection for pipes and conveyance
 - (ii) Topographical and environmental aspects
 - (iii) Easements (existing and/or new)
 - (iv) Clearances from underground services and structures
 - (v) Provision for future infrastructure and extensions to the upper limits of the subdivision including further capacity to cater for existing or future development upstream, subject to its zoning.
 - (vi) Location of secondary flow paths in relation to public and private assets.
- e) Hydraulic adequacy section 4.2.4.1
- f) Where applicable location of service connections

The following documents (refer Clause 4.1.2 for details) provide guidance in the design of pipes, culverts, detention and treatment devices and open channel hydraulics:

- The NZ Building Code (NZBC) compliance document Clause E1 Surface Water
- Auckland Council TP124 - Low Impact Design Manual for the Auckland Region
- Waikato Regional Council Best Practice Guidelines for Waterway Crossings
- AS-NZS Standards (various)

For catchments less than 8 hectares, surface water runoff using the Rational Method will be accepted. For larger catchments, or where significant storage elements (such as stormwater detention and treatment devices) are incorporated, surface water runoff should be determined using an appropriate hydrological or hydraulic computerised model. All modelling shall be carried out in accordance with the WRC’s Waikato Stormwater Runoff Modelling Guideline (May 2018) and the relevant (or HCC) SW Modelling Methodology and software.

A complete copy of the model shall be provided to Council at no charge. All underlying assumptions (such as losses, time of concentration, and catchment areas) shall be clearly stated (in the supporting report) so that a full check of calculations is possible.

4.2.3.3 Primary System Design Requirements

The land drainage system shall be capable of serving the entire catchment upstream of the development and must mitigate the effect it may have on downstream waterways and adjoining areas. It shall be designed within the terms of any approved Integrated Catchment Management Plan.

The means of stormwater disposal shall be capable of serving the whole of the lot. Where connection to the Council system is utilised the connection must be able to service at least the whole building and developed area available on the lot. Generally each lot will have a single stormwater connection.

- a) Concentrated stormwater runoff shall not be permitted to discharge across footpaths, berms, and from or to adjacent properties. Sheet flow from upstream lots or sub-catchments shall be intercepted by both the primary drainage system and the overland flow paths. The sheet flow must not create a nuisance to downstream lots, or present a danger to people and vehicles, by way of depth and velocity.
- b) Where further subdivision upstream of the one under consideration is provided for in the District Plan or Structure Plan, the stormwater systems are to be constructed to the upper limits of the developments under consideration.
- c) In all developments the preferred means of stormwater disposal shall be in accordance with Section 4.2.3.1.
- d) For the purposes of determining the increase in flow between pre and post-development reference shall be made to Section 4.2.4.4.
- e) Stormwater treatment devices such as wetlands, dry detention basins, rain gardens swales and filters etc are to be landscaped with vegetative cover as set out in Section 4.2.24. Landscape plans shall be submitted for the approval of Council prior to planting. For treatment devices constructed in conjunction with subdivision or Land Use consents, planting shall be completed and maintained as per the defects liability requirements (Section 4.5).
- f) At the time of submitting a design, Council will also require a draft Operations and Maintenance Manual in accordance with the requirements of Section 4.5 Prior to vestment, this manual shall be updated with monitoring results and finalised with any alterations discussed and agreed with Council. This includes any changes required by Waikato Regional Council for consent compliance.
- g) Under no circumstances shall stormwater be conveyed to or be permitted to enter a wastewater system.
- h) Subdivision and development (including any land modification) shall ensure that surface water runoff is appropriately managed in accordance with the drainage hierarchy in this Section.

Stormwater Pumping

Council considers that pumping of stormwater as a system solution is rarely a practical option because of the need for continuity of power supply and a very conservative approach to pumping design.

Applications for pumping stormwater as a smaller component (e.g. low lying sump) of an overall on site solution need to have exhausted the other available options and provide sufficient risk mitigation for pump malfunction and power outages.

Availability/Capacity of Council Stormwater Reticulation

Where a development will result in an increase in peak stormwater flow rates, Developers shall investigate the availability and capacity of existing Council channels (up to the 100 Year ARI event) or reticulation (up to the relevant LOS) to ensure the proposed additional flows to be discharged to them, can be accommodated. Council may request additional capacity if the proposed system is critical for the long term planning of growth.

4.2.3.4 Secondary System Design Requirements

Secondary systems shall consist of ponding areas and overland flow paths to manage excess runoff that cater for events exceeding the capacity of the primary system and occasions when the primary drainage system fails up to the 100 year ARI event.

Where possible, these secondary systems shall be located on land that is or is proposed to become public land. If located on private land, the secondary system shall be protected by an easement and consent notice. Public safety shall be incorporated into any design, e.g. street lighting to be considered if a cycleway/walkway is used

The easement and consent notice shall:

- Cover the full extent of the secondary flow path and shall not be less than 1.5m wide
- Have the effect of preventing alteration of the ground surface and prohibit the location of structures that might impede the flow of water across the land
- Be in favour of Council and/or the upstream lot(s) as appropriate

The easement shall be duly granted, reserved and shown on the survey plan.

Stormwater secondary flow paths shall be delineated to assist recognition and preservation of their purpose. [Drawing D4.4](#) shows the minimum treatment required.

Additional edge treatments and hardening of the base surfaces shall be provided where applicable due to surface flow volumes and velocities.

Secondary flow on roads shall be In accordance with Section 3 : Transportation (Clause 3.3.14.10). The design must not result in ponding greater than 150mm deep and a velocity greater than 1m/s.

4.2.3.5 Stormwater Treatment Requirements

Stormwater management can be supported by a number of different devices which remove typical urban contaminants through physical, biological and chemical processes. These devices can also provide retention and/or detention of frequent flows. Integration with flood management requirements needs to be considered to protect the treatment component of the device. The devices are summarised in Clause 4.2.16.

Treatment requirements are defined by the landuse and receiving environment. Land use contaminant categories are given in Table 4-4. The different categories result in

different pollutant profiles (and corresponding risks to receiving environments) which will determine the treatment device(s) selected.

The receiving environment determines the level and type (i.e. water quality or quantity) of stormwater treatment required to ensure an adequate level and type of protection is provided. In particular these define whether targets for just water quality or additional water quantity are required. Receiving environment categories are given in

Table 4-5.

A high level summary of treatment train requirements are provided in

Table 4-5. Treatment at source via private assets followed by a well-designed centralised treatment system (preferably a constructed wetland) to manage water quality and quantity impact is required and must be designed to manage the entire catchment. The final sequencing, scale and complexity of any treatment train must respond to the landuse and receiving environment and demonstrate compliance based on the pollutant removal attributable to the device and its overall cumulative performance.

Table 4-4 Landuse categories

LANDUSE CONTAMINANT CATEGORY	DEFINITION
Normal contaminant load profile	All land uses not identified as high below.
High contaminant load profile	Roads or intersections with VPD > 10,000 VPD ¹ , zinc or copper roofs, all industrial zones and uncovered carparks over 750 m ² .

¹ VPD counts >10,000 reflect road classifications ranging from high Volume Arterial roads to high Volume National roads as defined within the One Network Road Classification (ONRC)

Table 4-5 Receiving environment categories (excluding flood control)

RECEIVING ENVIRONMENT CATEGORY	DEFINITION	REQUIRED MITIGATION (REFER TABLE 4-3 FOR FURTHER DETAILS)
Natural Stream or modified channel	Downstream receiving environment includes a natural watercourse (including ephemeral), modified unlined perennial channel or surface wetland between the design point of discharge and receiving waters	Water Quality treatment, Extended Detention Volume (EDV), Water Quantity control flow attenuation/flood control as per Table 4-3.
River	All flows are conveyed via either piped system or concrete lined channel for entire length from legal point of discharge to receiving waters	Water Quality treatment. Water Quantity requirements dependent on system capacity.
Groundwater	Discharge to groundwater through infiltration or pumped injection	Water Quality treatment.

RECEIVING ENVIRONMENT DEFINITION CATEGORY	REQUIRED MITIGATION (REFER TABLE 4-3 FOR FURTHER DETAILS)
Lakes	Discharge directly to a natural or man-made lake Water Quality treatment. Water Quantity control (flow attenuation/flood control as per Table 4-3)

Table 4-6 Treatment train design requirements (excluding flood control)

LANDUSE CONTAMINATION CATEGORY	RECEIVING ENVIRONMENT CATEGORY	
	NATURAL STREAM OR LAKE	RIVER OR GROUNDWATER
Normal Contaminant Load Profile	Primary pre-treatment at source via selected water efficiency measure (required in accordance with some District Plans) ¹⁶ including detention tank, raingarden, rainwater reuse system (rain tank), permeable surfaces and soakage. Centralised stormwater treatment device, including EDV, sized for contributing catchment as per Table 4-3 and Table 4-4*	Primary pre-treatment at source via selected water efficiency measure (required in accordance with some District Plans) ¹⁶ , including detention tank, raingarden, rainwater reuse system (rain tank), permeable surfaces and soakage. Centralised stormwater treatment device sized for contributing catchment as per Table 4-3 and Table 4-4*
High Contaminant Load Profile	Primary treatment at source via Gross Pollutant Trap (GPT) or other private stormwater treatment device/s (which will include meeting any District Plan requirements) to manage high sediment loads and any contaminants specific to the landuse. Centralised stormwater treatment device, including EDV, sized for contributing catchment as per Table 4-3 and Table 4-4.*	Primary treatment at source via GPT or other private stormwater treatment device (which will include meeting any District Plan requirements) to manage high sediment loads and any contaminants specific to the landuse. Centralised stormwater treatment device, sized for contributing catchment as per Table 4-3 and Table 4-4.*

* Note. If there is no centralised device, at source requirements need to be specific to the land use and meet the parameters of Table 4-3 for the entire site.

4.2.4 Hydraulic Design Criteria

All new stormwater systems shall be designed to consider climate change adjusted design storms of at least the values set out in Table 4-7 unless specific approval has been obtained from Council.

Some Councils have different existing levels of service and the table is for any new works.

Table 4-7 : Design Level of Service

¹⁶<http://www.hamilton.govt.nz/our-council/council-publications/manuals/Pages/Three-Waters-Management-Practice-Notes.aspx>

RAINFALL INTENSITY RETURN PERIOD (ARI)	
Primary Systems	Years
Residential Area	10
Industrial Area	10
Commercial Area, Business, CBD	10
Community and Major Facilities	10
Parks, Reserves and Open Spaces	5
Rural and future Urban	5
Transport Corridor	5
Residential - falling away from public road	50
Secondary Systems	
Local Roads, Collector Roads, off road systems	100

4.2.4.1 Stormwater Flow Estimate

The runoff coefficients shown in Table 4.8 below are to be used for the various zones and are provided as a guide for initial calculation of system requirements. More accurate investigations into appropriate return periods and runoff coefficients will be necessary for detailed design. Detailed design should involve calculating a weighted average runoff coefficient by averaging the value for individual parts of the catchment. This may be done for a representative sample area or the whole catchment. The formula for this calculation is shown in Clause 2.1 of the Verification Method for the NZ Building Code, Clause E1 Surface Water (BC E1). The entire contributing developed catchment should be accounted for. Where a future land use is anticipated, the coefficient for that zone type should be used.

Table 4-8: Runoff Coefficients

ZONING	RUNOFF COEFFICIENT (C)
General Residential (HCC only)	0.80
General Residential (excluding HCC)	0.65
Residential Intensification Zone (HCC only)	0.85
Residential Medium/High Density	0.80
Industrial	0.85
Community and Major Facilities	0.80*
Parks, Reserves and Open Spaces	0.35
Rural	0.25
Transport Corridor	0.8

ZONING	RUNOFF COEFFICIENT (C)
Central City Precinct 1, Business zones 1-6	0.95
Central City Precincts 2 & 3	0.85

* Coefficient may vary significantly dependent on specific land use and impervious coverage. Where Community or Major Facilities comprises large pervious coverage (such as sporting facilities or large institutions) the coefficient can be lowered with specific agreement with Council.

In refining the estimate of runoff coefficients provided in Table 4-8, the BC E1 Table 2 shall be used. The coefficients in Table 4-9 are provided as a guide.

Table 4-9: Runoff Coefficients Refined

SURFACE	RUNOFF COEFFICIENT (C)	RUNOFF COEFFICIENT (C) IF COMPACTION IS LIKELY DURING DEVELOPMENT
Roofs	0.95	NA
Asphaltic and Concrete Areas	0.90	NA
Uncultivated Ground, Lawns and Playing	0.30	0.5
Cultivated Ground and Dairy Farmland	0.20	0.5

Catchments Larger than 8ha

For larger catchments (greater than 8Ha), or where significant storage elements are incorporated, surface water runoff should be determined using an acceptable hydrological or hydraulic model that complies with Council’s modelling methodology and software and WRC’s Waikato Stormwater Runoff Guideline (June 2018).

4.2.4.2 Time of Concentration

The time of concentration shall be determined as the ‘time of entry’ plus the ‘time of flow’ from the furthest part of the whole catchment to the point of discharge.

Time of entry to the system shall be calculated from the Overland Flow Graph in Figure 4-2, or an equivalent published graph or the formula from which it was derived.

Time of flow can be calculated from the flow velocity in pipes and channels.

Note: since time of concentration is not known initially, an iterative type solution is necessary with time of concentration recalculated from the catchment flow calculation.

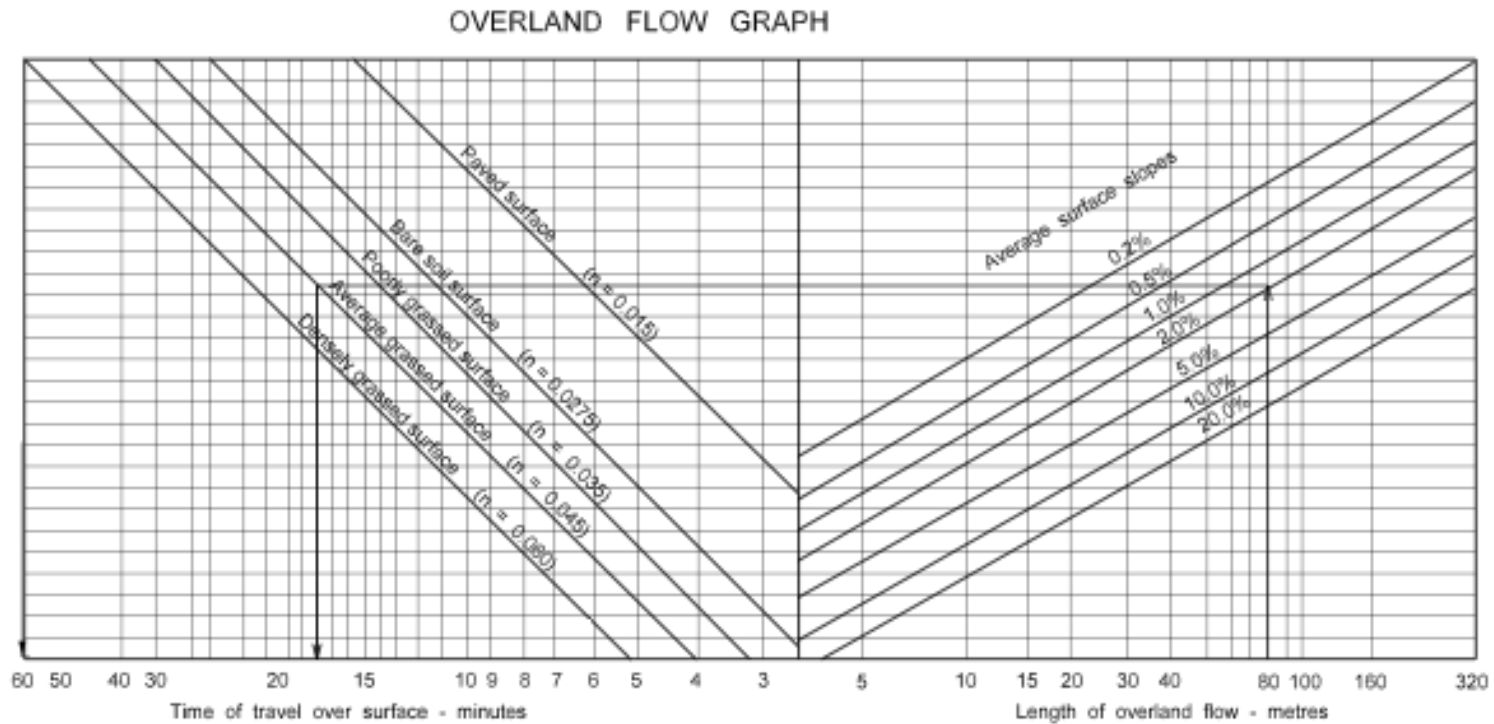

FORMULA $t = \frac{107n \sqrt{s}}{5}$

Where:-
 t = time of travel over surface in minutes
 n = Horton's values for the surface
 L = length of flow in metres
 s = slope of surface in %

EXAMPLE
 Length of over land flow 80m
 Average slope of surface 2%
 Average grassed surface
 Time of travel 18 minutes

Data attributed to U.S. Dept. of Agriculture 1942
 Nomograph published in "Municipal Utilities" Sept. 1951

Drawing 4-1: Overland Flow Graph

4.2.4.3 **Design Rainfall**

Rainfall design data is to be derived using HIRDS at www.hirds.niwa.co.nz

4.2.4.4 **Design Storm Detention**

In any greenfield development where detention storage is present or will be required, the stormwater design shall be based on hydraulic modelling or other methods in accordance with Table 4-7: Design Level of Service. A 24-hour nested design storm, as found in HIRDS, shall be used for pre-development flows (without climate change adjustment) and plus 2.1°C (with climate change adjustment) for post development. If the catchment has a very long response time, it may be necessary to deviate from the 24 hour storm.

4.2.4.5 **Energy Loss through Structure**

Energy loss is expressed as velocity head:

Energy loss:

Equation 4-1: Stormwater energy loss

$$H_e = kV^2/2g$$

where k is the entrance loss coefficient and V is velocity.

The entrance loss coefficient table and energy loss coefficient graph in BC E1 provide k values for flow through inlets and access chambers respectively.

For bends, see Table 4-10 below.

Table 4-10: Loss Coefficients for Bends

BENDS		K
Manhole properly benched with radius of bend	1.5 x pipe diameter In mm	0.5 to 1.0
Bend angle	90°	0.90
	45°	0.60
	22.5°	0.25

4.2.4.6 **Determination of Water Surface Profiles**

Stormwater systems shall be designed by calculating or computer modelling backwater profiles from an appropriate outfall water level. On steep gradients both inlet control and hydraulic grade line analysis shall be used and the more severe relevant condition adopted for design purposes. For pipe systems at manholes and other nodes, primary (and if secondary) water levels computed at design flow shall not exceed finished ground level while allowing existing and future connections to function satisfactorily.

In principle, each step in the determination of a water surface profile involves calculating a water level upstream (h2) for a given value of discharge and a given start water level downstream (h1).

This can be represented as:

Equation 4-2: Determination of water surface profile

$$h_2 + V_2^2/2g = h_1 + V_1^2/2g + H_f + H_e$$

where

V is velocity,

H_f is head loss due to boundary resistance within the reach (for pipes, unit head loss is read from Manning's flow charts),

H_e is head loss within the reach due to changes in cross section and alignment (refer Table 4-14 for loss coefficients).

4.2.4.7 Minimum Pipe Diameters

- a) Irrespective of other requirements, the minimum pipe size for a public stormwater pipe shall be not less than DN150 and a lateral connection not less than DN100.
- b) In no circumstances shall the pipe size be reduced on any downstream section.

Table 4-11: Minimum Pipe Sizes

SITUATION	MINIMUM SIZE (MM)
Single catchpit lead	225 Smaller pipes are permitted for serving <u>private</u> ROW catchpits
Double catchpit lead	300
Single dwelling	100
2 - 3 dwellings	150
Stormwater Network Pipe	150

4.2.4.8 Minimum Gradients and Flow Velocities in Pipes

Pipe gradients should be at a grade that prevents silt deposition. The minimum velocity should be at least 0.6m/s at a flow of half the 2 year ARI design flow. For velocities greater than 3.0m/s specific design to mitigate erosion is required.

4.2.5 Watercourses

Natural watercourses are expected to be retained.

Refer to the relevant District and Regional Plan(s), to ensure all planning requirements are incorporated into any design. Also refer to the Council's Drainage Bylaw.

The extent of stream drainage work shall be designed to achieve a satisfactory solution recognising:

- Community flood protection
- Bank stability
- The retention of the natural topography and ecological values
- Maintenance

- Hydraulic and safety considerations
- Downstream effects of the work

4.2.5.1 Constructed Watercourses

Constructed watercourses (typically highly modified open drains) may be piped if there are valid engineering or design considerations, ecological impacts have been considered and Waikato Regional Council approval is obtained where necessary. The engineering plans should be noted accordingly.

Where perennial or ephemeral constructed waterways are to be incorporated in the stormwater system, they shall be located within a reserve of sufficient width to contain the full design storm flow from a 100 Year ARI event with a minimum freeboard as per Table 4-3. Where these waterways are being naturalised, the design must ensure that there is no increased risk of erosion and/or scour and the ecological health of the waterway is maintained or enhanced. Any stormwater discharge to a watercourse must comply with the requirements presented in

Table 4-5.

Grass berms in reserves shall have a maximum side slope of 1 in 5 for mowing and additionally include a vehicular access berm for maintenance purposes.

Planted riparian margins shall be provided each side of the waterway and shall consider maximisation of bank stability and public safety.

All channel infrastructure shall include protection against erosion and scour of the stream banks and stream bed using natural treatments where feasible.

If the constructed watercourse is to be in private property, discussions will need to be held with Council to determine responsibility for maintenance. At minimum the constructed watercourse shall be protected by an easement and constructed in compliance with [Drawing D4.4](#).

4.2.5.2 Natural Open Stream Systems

Where natural open stream systems or formed channels are to be incorporated in the stormwater drainage system they shall be located within a drainage reserve of sufficient width to contain the overall system design storm flow. Any stormwater discharge to a watercourse must comply with the requirements presented in Table 4-3.

- a) It must be demonstrated that the open drain system:
 - (i) Can be used where it is in keeping with the existing drainage system
 - (ii) Is the only option available that will work hydraulically
 - (iii) Provides at least the same capacity as an equivalent piped system
 - (iv) Where ash, clay or pumice soils are present, the maximum velocity in an unlined open drain shall be 0.5m/sec. When this is unable to occur, an appropriate channel lining will be required
- b) Drainage reserves that are to be mowed shall have slopes of between 1:5 and 1:50, unless they are a natural watercourse. When access for maintenance is required, access provisions shall also include:
 - (i) A 4m wide berm that is able to be driven on by an 8.2 tonne axle weight vehicle for its entire length and provision for turning (if applicable).

- (ii) Access from a road
- c) To encourage the best use of the open stream systems the drainage reserve shall, where possible, be linked with other reserves and open spaces to accommodate off road pedestrian and cycle access. Access points for public use and maintenance shall be provided at regular intervals along the system together with footpath and pedestrian bridges, as may be defined in the resource consent.
- d) The flow characteristics of natural open stream systems shall:
 - (i) Be based on the likely long term stream condition in terms of density of vegetation
 - (ii) Be cleared of all unsuitable plant growth and replanted to a landscape design approved by Council
 - (iii) Take account of the possibility of blockage under all peak flood conditions
 - (iv) Include protection of the low flow channel against scour and erosion of the stream bed where necessary
 - (v) Not be changed by the discharge of stormwater resulting from development or a new discharge to the stream
 - (vi) Be designed to avoid erosion of the stream banks
- e) Catchment or detention factors that may lead to an increase in the temperature of the stormwater (e.g. large sealed areas) shall be mitigated in accordance with an approved ICMP or
- f) Table 4-5.

Where a section of watercourse is to be piped (e.g. for crossings), reference shall be made to Section 4.2.12.

4.2.6 Piped System Layout

The preferred layout/location of pipes is as follows:

Table 4-12: Pipe Locations

AREA	LOCATION
Residential	Within the Transportation Corridor normally 2m out from the kerb except where the properties served are below road level. Manholes should be located, wherever possible, in the centre of the moving lane.
Industrial	Within the Transportation Corridor normally 2m out from the kerb alternatively in the front yard area with specific council agreement
Business	Within the Transportation Corridor normally 2m out from the kerb or alternatively in the rear service lane with specific council agreement.
Other Areas	Within the Transportation Corridor except where the properties served are below road level
Private Property	<p>If no other option is available, pipelines may be laid within private property.</p> <p>Where a pipeline is within a property, it is required to be parallel to, and no closer than 1.5m from a boundary.</p> <p>No new private drains shall pass between one lot and another. If crossing of private property is unavoidable, those parts of the pipeline serving more than one lot shall be Council mains with service connections to the property boundaries or protected by public or private easement. The public easement width shall be based on the 45° zone of influence centred on the pipe, and be a minimum of 1.5m. The major</p>

AREA	LOCATION
	reticulation and trunk lines however, shall be in the Transportation Corridor.

Where a stormwater pipeline changes location within a street, crossings of roads, railway lines, and underground services shall, as far as practicable, be at an angle of 45 degrees or greater. Pipes shall be located and designed to minimise maintenance and crossing restoration.

4.2.6.1 Topographical considerations

In steep terrain the location of pipes is governed by topography. The pipe layout shall conform to natural fall as far as possible to remove the need for gravity pipelines operating against natural fall and thus creating the need for deep installations.

4.2.6.2 Minimum/Maximum Cover

All pipelines shall be specifically designed to support the likely loading in relation to the minimum cover to be provided in accordance with AS/NZS 3725. The minimum cover for all types of pipes shall be 600mm (including during construction). Vehicle entrance culverts may be reduced to 250mm cover but the pipe class and backfill will need to be specifically designed.

For private pipelines in private property the depth of cover is dealt with under the Building Act and accepted by the Council’s building section.

4.2.6.3 Clearances from Underground Services

Clearance from underground services shall be as per NZS 4404 Section 5.3.7.9.

4.2.6.4 Clearance from Structures

Pipes adjacent to existing buildings and structures shall be located clear of the ‘zone of influence’ of the building foundations. If this is not possible, a specific design shall be undertaken to cover the following.

- Protection of the pipeline
- Long term maintenance access for the pipeline
- Protection of the existing structure or building

The protection shall be specified by the Developer for evaluation and acceptance by Council.

Sufficient clearance for laying and access for maintenance is also required. Table 4-13 may be used as a guide for minimum clearances for mains laid in public streets.

Table 4-13: Minimum Clearance from Structures

PIPE DIAMETER DN (MM)	CLEARANCE TO WALL OR BUILDING (MM)
<100	600
100 – 150	1000
200 – 300	1500

PIPE DIAMETER DN (MM)	CLEARANCE TO WALL OR BUILDING (MM)
375 +	1500 + 2 x diameter

NOTE – These clearances should be increased by 400mm for mains in private property as access is often more difficult and damage risk is greater.

4.2.7 Manholes

Manholes are to be located:

- On Council property or Transportation Corridors whenever possible and if located within the carriageway, the manholes shall be located 2m out from the kerb
- Clear of all boundary lines by at least 1.5m from the outer edge of the manhole chamber plus the height of any nearby retaining walls if they exist
- 2m clear of new structures in private property as shown in [Drawing D5.6](#)
- Clear of wheel tracks to minimise noise and vehicle user discomfort

Manholes are required at the following locations.

- Intersection of pipes except for junctions between mains and lateral connections
- Changes of pipe size
- Changes of pipe direction, except where horizontal curves are permitted
- Changes of pipe grade, except where vertical curves are permitted
- Combined changes of pipe direction and grade, except where compound curves are permitted
- Changes of pipe invert level
- Changes of pipe material, except for repair/maintenance locations
- Permanent ends of a pipe

For infill developments, manholes shall not be required for a DN150 connection on a DN150 pipeline where a manhole is provided immediately inside the property being served and another manhole is within 100m as these provide adequate accessibility.

4.2.7.1 Distance between Manholes

For reticulation pipes less than DN900, the maximum distance between any two manholes shall be 120m.

On pipelines DN900 and greater, but less than DN1800, the spacing of manholes may be extended up to 200m. On pipelines DN1800 or greater, the spacing may be extended up to 300m between manholes.

Uniform curvature on pipelines DN900 and greater may be permitted providing that joint deflections are within the limits of the manufacturer's recommendations.

Branch lines should normally be connected into a manhole. However branch lines DN300 and smaller may be saddled on to pipelines DN600 or larger, providing a manhole is supplied on the branching line within 40m of the main line. Factory made 'Y' connections shall be used.

4.2.7.2 Stormwater Manholes on Larger Pipelines

Manholes on stormwater pipelines more than DN600 shall have a minimum diameter equal to the largest pipe size plus 450 mm.

On larger pipelines, recessed steps with rungs may be required below pipe benching level. In all cases, the lowest rung must be easily reached by a person standing at invert level (see [Drawing D4.22](#)).

4.2.7.3 Size of Manholes

Manholes shall be a minimum of DN1050 for depths of 1.0m or more.

Manholes of DN750 are permitted to be used for depths less than 1.0m at the upstream end of public drains.

4.2.7.4 Manhole Materials and Parameters

All Manholes shall be pre-cast concrete with an external flange base.

Manholes up to 2400mm deep shall be constructed using a single riser with a pre-cast external flange base. Manholes in excess of 2400mm deep shall be constructed using a 2400mm deep pre-cast riser with external flange base and then completed to final ground level using no more than a single riser for manholes up to 5.0m deep. Three risers are allowable for manholes in excess of 5.0m depth.

In no case shall a series of short risers be permitted.

The joints of all abutting units shall be sealed against ingress of water by the use of Expandite BM100 'Sealastrip' or an approved equivalent.

The cover frame shall be set over the opening and adjusted to the correct height and slope using adjustment rings and mortar so as to conform to the surrounding surface (refer to Drawings [D4.21](#) to [D4.23](#)). The cover frame shall be held in place with a bold fillet of concrete.

4.2.7.5 Manholes Requiring Specific Design

Consideration must be given to the design of manholes to ensure safe entry.

Where manholes are more than 5.0m deep they shall be specifically designed in accordance with the manufacturer's requirements for external pressures and resist floatation.

Where a manhole is to be constructed in soft ground, the area under the manhole shall be undercut to provide an adequate foundation and backfilled with suitable hard fill for the manhole base. Where undercutting exceeds 1.5m, a special design will be required.

4.2.7.6 Flotation

In areas of high water table, all manholes shall be designed to provide a factor of safety against flotation of 1.25.

4.2.7.7 Internal fall through Manholes

In addition to the normal pipeline gradient, all manholes shall have a minimum drop of 20mm plus 5mm per 10 degrees of the angle of change of flow within the manhole.

The construction tolerance for drop through the manhole shall be:

Constructed Manhole Drop = Manhole Drop (as calculated above) +/- 5 mm

Grading the channel shall be limited to falls through manholes of up to 150mm.

To avoid excessively steep channels within manholes, steep grades shall be 'graded-out' at the design phase where practicable.

4.2.7.8 Covers

Manhole covers with a minimum clear opening of 600mm in diameter, complying with AS 3996, shall be used. Refer to [Acceptable Products Section 8](#).

- a) 'Non-rock' covers must be used on all State Highway and Level 2 roads (with greater than 10,000 vehicles per day). Note: NZTA have their own requirements for manholes (see NZTA P46 Stormwater Specification).
- b) 'Heavy Duty' covers must be used in the transportation corridor, commercial and industrial properties and all public areas.
- c) 'Standard' covers may only be used in residential properties.

4.2.7.9 Manhole Steps

All manholes shall be provided with non-slip steps as set out in the Acceptable Products Section 8 in order to provide safe access. These shall be of the 'dropper' or 'safety' type to prevent feet sliding sideways off them.

Manhole steps shall be provided at 300mm centres vertically (refer Drawings [D5.1](#) – [D5.2](#)). The top step shall not be more than 450mm below the top of the top slab, and the lowest step shall be not more than 375mm above the bench, or such lower level if detailed on other than standard manholes.

4.2.7.10 Connections to Manholes

Open cascade is permitted into manholes over 2.0m in depth and for pipes up to and including 300mm diameter providing the steps are clear of any cascade. Refer to [Drawing D4.21](#).

The bases of all manholes shall be benched and haunches to a smooth finish to accommodate the inlet and outlet pipes.

Pipelines connecting at or below design water level in the MH shall do so at an angle of not greater than 90 degrees to the main pipeline direction of inflow. Local pipelines connecting above design water level may do so at any angle.

The invert of a private connection must connect to the manhole at a level no lower than the average of the soffit levels of the main inlet and outlet pipes.

4.2.8 Connections

4.2.8.1 General

The lateral connection should be designed to suit the existing situation and any future development.

For all connections to an open watercourse, resource consents from Waikato Regional Council may be required.

Connections are private to the point of discharge and then become public. The point of discharge can vary between councils so developers/contractors need to check this with the relevant council.

Refer to [Drawing D4.18](#) for connection layouts.

4.2.8.2 Design Requirement

The following design requirements shall be met:

- a) Stormwater management as per hierarchy in Section 4.2.3.1
- b) Where no other option is available, a 'bubble-up' discharge to the kerb and channel will be required in the residential high density, commercial and industrial areas. Kerb and Channel connections can be used in place of 'bubble-up' outlets in normal residential zones where, there is a suitable kerb profile and, the connection outlet can be installed at least 1.0m clear of any vehicle crossing.
- c) If connecting to a public pipe, the standard depth of a stormwater connection at the boundary is 1.2m (allowable range 0.9 m - 1.5 m), or to such depth that permits a gravity connection to service the whole lot.
- d) To determine whether a connection can serve the whole developable area of the lot, the invert level should be calculated at grade 1:80 from the public pipeline invert to the lot boundary and then at 1:100 to the furthest point within the lot. If after allowing for the pipeline diameter, the depth of cover over the pipeline is less than 500mm, the design will need to be to the satisfaction of Council's building section.
- e) Existing connections, not documented on Council records may be reused subject to confirmation of existing construction suitability and as-built information is provided to update Council's records.
- f) Detention of stormwater prior to release to the Council system is required as per Table 4-3. Early consultation is encouraged with Council staff for a suitable solution for the development.
- g) Minimum size for connections is as per Table 4-11.
- h) All connections, which are to be made directly to the line, shall be designed using a factory manufactured 'wye' or 'London Junction' and shall be watertight.

The system design shall allow for the above events to be contained within the development boundaries. Secondary flows for up to the 100 year event shall be considered against the Level of Service within Section 4.1.3.

4.2.8.3 Services in Accessways, Access Lots, or Rights of Ways

The following should be considered when preparing the design where separate connections are not possible, and not inclusive of the right of way drainage itself:

- a) Where drainage is to a piped system refer to Drawing D4.18.
- b) Council will adopt the stormwater system in the right of way where it services 2 or more properties. All private drainage reticulation that has been upgraded in accordance with this standard shall be declared public at the point where it crosses a boundary once as-built information has been recorded by Council.

4.2.8.4 Multi-Unit Properties

For multiple occupancy situations, service of the whole property shall be achieved by providing a single point of connection to the Council stormwater system where

applicable. Connection of the individual units is by joint service pipes owned and maintained by the body corporate, tenants in common or the company as the case may be. In this instance the whole of the multiple occupancy shall be regarded as a single lot. All drainage within the development boundary will be considered to be private.

- Pipe Size and material shall be determined by site-specific design in accordance with Compliance Document for the NZ Building Code Clause E1 Surface Water or this document
- A manhole/chamber is to be provided just within the lot boundary.

4.2.8.5 Ramped Risers

Unless required otherwise by Council, a ramped riser shall be constructed to bring the connection to within 0.9m - 1.5m of ground level, or to such depth that will permit a gravity connection to service the whole developable area of the lot. Ramped risers shall be constructed as shown in Drawing D4.4.

4.2.8.6 Connections to Deep Lines

Where an existing or proposed main is more than 5m deep, or where required by the ground conditions, a satellite manhole will need to be constructed on the shallower connection within 5 metres of the deep main laid from the manhole in accordance with Section 4.2.7.

4.2.9 Building Over or Adjacent to Pipelines

Building close to or over pipelines is generally discouraged as this practice severely limits Council's ability to either maintain or duplicate the pipeline if required in the future.

4.2.9.1 General

Council does not permit building over or within the specified distances of the following infrastructure (refer Drawing D5.6):

- Connections – 2 metres
- Manholes – 2 metres

The pipe must be located on site so this assessment can be made.

Alternative options such as relocating the proposed building, or decommissioning of/or diverting the pipeline along property boundaries, shall be thoroughly investigated by the development before building over a pipeline will be permitted.

In order of preference pipes shall either be:

- removed (where practical) and connections relocated, dependent on usage capacity for the pipe, at a cost to the development (Refer to Section 451 of Local Government Act 1974)
- relocate to avoid the construction, and at a cost to the development (s451 of LGA 1974)
- replaced on present alignment, extending from boundary to boundary (or manhole as appropriate) at a cost to the development (s451 of LGA 1974)

The Developer/Applicant will be responsible for all costs associated with:

- Investigation and design associated with seeking approval;
- If approval is granted, then construction;
- Repairing any damage to a stormwater main or associated stormwater infrastructure caused by construction over or near an existing pipe;
- The creation or relocation of easements.

4.2.9.2 Inspection

Any application to build over or within 5m of an existing public sewer must include the following:

- A CCTV inspection of the subject sewer, in accordance with Section 2 of the New Zealand Pipe Inspection Manual, undertaken by a contractor qualified and with the necessary experience to do so, or by Council at the applicant's expense. An entry permit will be required and approved if the contractor needs to enter manholes and/or pipe.
- The results of the CCTV inspection are to be submitted to Council with the application. The inspection may be used as a dilapidation survey.

Pre-inspections are required to confirm the location of the pipes traversing the entire development site, their condition and to ensure connections are not built over.

Building or Engineering plans submitted to Council need to also incorporate the confirmed locations of the main, manholes and connections identified by the CCTV inspection as these factors may impact on the development layout/design.

Post inspections are required when any construction involves piling within the 45° influence envelope of the pipe to ensure no damage has occurred during installation of piles/foundations.

No further construction work can be carried out until results are known from the Post Inspection.

Should the CCTV inspection identify faults, council may require the developer to:

- Repair the stormwater main in its existing location using construction materials as specified by Council to accepted plans; or
- Reline the existing stormwater main by a suitably qualified contractor.

All works on gravity stormwater mains must be completed for the full extent between manholes.

4.2.9.3 Structural loads – building over

No structural loads shall be placed on, or be transferred to the pipeline, or other assets. All structural loads shall be absorbed (by means of piles where appropriate) outside of the 45° influence envelope and below the invert level of the pipe for the first row of piles (refer [Drawing D4.26](#)).

The first row of piles shall be located at least 1.5m clear from the outside edge of the pipe and 2.0 m clear from the outside wall of any public manhole, and be founded at least 1.0m below invert level of pipe.

Subsequent pile rows shall be founded at least 1.0m below the 45° envelope of the influence line of the pipe at invert level.

4.2.9.4 Building adjacent to

Any building, structure (including retaining wall) or other development shall be designed and founded so that it will not be adversely affected by public infrastructure and associated trench line, including any future excavation that may be required for the maintenance of the infrastructure. The building, structure or other development shall make provision to allow for any future possible settlement of the public trench line and backfill. CCTV inspection of all pipes is required before and after construction.

4.2.9.5 Pile Ramming

No pile ramming is permitted within 5m from the centreline of any public pipe, or within the 45° envelope of the influence line of the pipe at invert level. Pile ramming includes sheet piling.

These piles shall be drilled only.

4.2.9.6 Abandoned Mains

Mains which have been abandoned may remain in the ground providing they are capped. Council may require certain abandoned mains to be backfilled with grout depending on size, material type and proximity to other structures.

If the abandoned mains are required to be removed then the trench shall be backfilled and compacted to at least 98% standard compaction.

4.2.9.7 Excavating over Pipes

Excavations over or adjacent to a stormwater main are not to reduce the cover over the main to less than the minimum limits in accordance with the AS/NZS standard relevant to the pipe material.

4.2.10 Catchpits

The design and construction of catchpits shall be undertaken so that:

- a) Catchpit capacity matches the design catchment.
- b) The impact of a blockage or ponding is addressed.
- c) Catchpits are capable of capturing and retaining the majority of gross pollutants, and floatable contaminants including oil and grease.
- d) Catchpits shall be accurately positioned so that the grate and kerb block fit neatly into the kerb and channel. Rectangular pits shall be oriented with the longer side parallel to the kerb.
- e) Catchpit leads shall be of the size and material detailed on the plans or specification.
- f) Catchpit leads not more than 300 mm diameter and not more than 20 m in length may be saddled on to pipes 600 mm diameter and larger, without manholes.
- g) Technology regarding pre-treatment devices within catchpits is continuously evolving. Where devices are required, consultation with Council is required to ensure the proposed device meets with Councils operations and maintenance requirements. Any alternative designs of stormwater catchpits shall be capable of capturing and retaining the majority of gross pollutants and floatable contaminants such as oil and grease.

- h) Drawings D4.6 – D4.10 provide details for the construction of catchpits.
- i) Refer Acceptable Products Section 8 for list of permitted precast components.

4.2.11 Outlets and Inlets

Approved structures shall be constructed at the inlets and outlets of pipelines.

Where a pipeline discharges into a natural or constructed waterway, consideration shall be given to energy dissipation or losses, erosion control and land instability. This is usually achieved by an appropriately designed headwall. Refer to Auckland Council's TP10¹⁷ and TR2013/018.

Where outlets or inlets are located on or near natural waterways their appearance in the riparian landscape and likely effect on in-stream values shall be considered. Methods could include cutting off the pipe end at an oblique angle to match slope, constructing a headwall from local materials such as rock or boulders, planting close to the structure and locating outlets well back from the water's edge.

4.2.11.1 Waikato River Outfalls

Outfalls to the Waikato River need to be reviewed by both Waikato-Tainui and Mighty River Power in conjunction with seeking approval from Council and the Waikato Regional Council. Outlets should not be located in sites of recognised cultural or historical significance.

Note relevant documents:

- The Central Waikato River Stability Management Strategy
- Waikato-Tainui Raupatu Claims (Waikato River) Settlement Act 2010
- Joint Management Agreements (JMA)

4.2.11.2 Outlet Design (Streams and Rivers)

For outlets the design shall ensure non-scouring velocities at the point of discharge. Acceptable outlet velocities will depend on soil conditions, but should not exceed 2m/s without specific provision for energy dissipation and velocity reduction. (Engineering designs must clearly illustrate this.)

Outlet designs shall incorporate the following:

- a) Alignment with an approved Integrated Catchment Management Plan, Catchment Management Plan or Water Impact Assessment
- b) Fit for purpose over the design life
- c) Receiving waters level and flows
- d) Receiving waters bank erosion protection (0.5m below minimum Waikato river level where applicable)
- e) Energy dissipation and the design shall ensure non-scouring velocities at the point of discharge
- f) Seasonal variations in power generation

¹⁷ will be replaced by the WRC's Waikato Stormwater Management Guideline (May 2018)

- g) Extending outlet works below the water surface
- h) Developing a consistent design criteria for outlet works taking into account public safety requirements, natural character of the surrounds, amenity and aesthetics of the river
- i) Appropriate planting of eco-sourced indigenous species where required
- j) Retaining and enhancing remnant areas of indigenous bank vegetation
- k) Consideration of fish passage requirements

4.2.11.3 **Outfall water levels**

Where a pipeline or waterway discharges into a much larger system the peak flows generally do not coincide. Backwater profiles should produce satisfactory water levels when assessed as follows:

- a) Determine the time of concentration and set the design rainfall event for the smaller system;
- b) Determine the peak flow for the design event;
- c) Determine receiving waterway peak water level for the design rainfall event in (a);
- d) Starting with the level from (c) determine the smaller system profile at the flow of 75% of the flow from (b);
- e) Determine the receiving waterway mean flood water level;
- f) Starting with the level from (e) determine the smaller system water profile at the flow from (b);
- g) Select the higher of the two profiles determined for design purposes.

4.2.11.4 **Inlet Design**

The inlet design should take into account particular circumstances at each site using the following evaluation and guidelines below:

- Direction of upstream flow
- Signs of erosion both lateral and down cutting
- Height of headwall
- Need for overland flow path
- General aesthetics
- Hydraulic efficiency
- Fish passage

The selection of a suitable location may influence the pipe alignment. Generally a minimum clearance of 1.0m shall be provided clear of the opening around any inlet structure that may allow entry for maintenance and rescue equipment. Council may determine other specific requirements subject to individual site characteristics.

Screens are required where flow from pipes (300mm and over), open drains, detention and treatment systems enters into a piped system (excluding culverts).

All screens shall be constructed from hot-dipped galvanised steel and the horizontal gap shall not exceed 100mm.

Specific design is required to meet the requirements of the site and public safety issues including the provision of access to the inlet structure for maintenance and cleaning of blockages.

Screens are to be designed to minimise the build up of material and to withstand the loads imposed by debris blocking the inlet and the resulting hydraulic head. Where the consequences of a screen blockage are likely to be severe, a backup overflow system that allows runoff to enter the pipe or a clearly defined secondary flowpath shall be provided. Refer to Australian Rainfall and Runoff Guide - Project 11.

4.2.12 Culverts

Culverts shall be designed for the 1% AEP Post development event.

In designing culverts the effects of inlet and outlet tailwater controls shall be considered.

Culverts under fill shall be of suitable capacity to cope with the design storm as per Table 4-14 with no surcharge at the inlet, unless the fill is part of a stormwater detention device or has been designed to act in surcharge. All culverts shall be provided with adequate wingwalls, headwalls, aprons, scour protection, removable debris traps or pits to prevent scouring or blocking.

When boxes/pipes or culverts are placed side-by-side to create a width of greater than 6.0m, the culvert is defined as a bridge culvert – these shall be designed in accordance with the NZTA Bridge Manual (SP/M/022), Waikato Regional Council document 'Best Practice Guidelines for Waterway Crossings' for fish passage and Clause 3.3.27.1 of the Transportation section of this document.

Culverts shall retain stream width, natural bed material and unimpeded fish passage. The design shall optimise low velocity zones, minimal turbulence, light, longitudinal bed gradient, bed level that is not raised. The design shall minimise upstream flooding, blockages and scouring.

If culvert design results in upstream ponding of more than 4 metres, it is considered a 'dam' Refer to Waikato Regional Council's document 'Building a Dam'.

Where the culvert is designed as a multi-barrel device, the inlet should be designed to favour one barrel to carry the low flow in direct line of the stream with the other barrel(s) off set. This is also favourable for fish passage. The number of barrels should be limited to ensure that the general stream profile is not unduly disturbed. To achieve this it is expected that the overall distance to the outside collars of the barrels would not exceed the naturally available stream channel.

Waikato Regional Plan rules also stipulate design and consent requirements for the number of hectares in a catchment being drained through a culvert.

It is usual for resource consents to require that culvert construction be accompanied by sediment control measures as set out in an Erosion and Sediment Control Plan. Refer to Waikato Regional Council's Erosion and Sedimentation Guidelines.

4.2.12.1 Design Storm

Culverts shall be designed as a minimum to accommodate storms as per Table 4-14 below. The design shall not cause any increase in upstream water levels that will cause flooding on neighbouring properties.

Table 4-14: Culvert design storms

DESIGN CASE	ARI YEAR STORM TO PASS WITHOUT SURCHARGE (DESIGN FLOW)	ARI YEAR STORM NOT OVERTOPPING STRUCTURE (PEAK FLOW)
Driveway or private accessway	2	NA-
Pedestrian or cycleway walk	5	10
Local or Collector Road	5	100
Arterial roads and railways	20	100

4.2.12.2 General Design Criteria

The following general design criteria for culverts shall apply:

- a) The culvert must never be more than half full at average flow.
- b) Generally, culverts shall accommodate the full width of the stream at average flow.
- c) Where flows are typically concentrated in circular barrel culverts, the culvert diameter shall be larger than the stream width at average flow. A rule of thumb is $1.2 \times \text{channel width} + 0.5\text{m}$.
- d) Culvert diameter shall be selected that design peak flood flow can pass without the culvert embankment being overtopped. This reduces the likelihood of the embankment failing due to scour.
- e) Culverts shall be designed so that if they do overtop, it will be without causing structural failure.
- f) Culverts shall be sized so that the largest bed material in the stream can pass either through or over the culvert.
- g) Ponding behind the culvert embankment should not exceed 1.0m above the soffit, unless high water velocities are likely to cause scour around the culvert entrance and exit.
- h) The invert of the culvert pipe shall be below the waterway bed level by a factor of 20% of the culvert diameter.
- i) Culverts under fills shall be of suitable capacity to cope with the design storm with no surcharge at the inlet, unless the fill is part of a stormwater detention device or has been designed to act in surcharge. Special consideration shall be given to the effects of surcharging or blocking of culverts under fill (e.g. anti-seep collars).
- j) The culverts inlet and outlet will be flush with the headwall.
- k) Culverts shall be designed so that they are placed on a straight section of channel where the channel gradient is lowest.
- l) Spillways shall be provided to cater for the overtopping scenario when flows exceed the design flow and may require armouring to prevent erosion.
- m) To reduce potential for excessive turbulent flow which can cause downstream erosion, the design shall incorporate baffles or rocks, where the culvert does not have a natural stream bed. The design of this feature shall reduce the exiting flow to that of the receiving water.
- n) Freeboard shall be provided as described in Figure 4-1.

4.2.12.3 Fish Passage

Fish passage through culverts shall always be maintained or provided. This is achieved by ensuring that the invert level is set below the stream bed level and the outlet is flooded at all times.

The Waikato Regional Council shall be consulted to determine ecological value of the waterway. In some cases, fish barriers will be desired because of their ability to prevent migration of pest fish.

Note: it may be a requirement of Waikato Regional Council that construction shall avoid spring and early summer.

If a waterway is reduced, the velocity along the banks at normal flow should be maintained at less than 0.3m/s to allow for passage of indigenous fish and trout.

Where multi-barrel circular culverts are to be used for wide channels that have low flows but occasional high flow events, the inlet should be designed to favour one barrel to carry the low flow in direct line of the stream with the other barrel(s) off set. The number of barrels should be limited to ensure that the general stream profile is not unduly disturbed. To achieve this it is expected that the overall distance to the outside collars of the barrels would not exceed the naturally available stream channel.

Continuous fish passage to off line constructed wetlands is not required where it limits the ability to manage system hydraulics to optimise water quality treatment. However, provision must be made for fish passage either through the wetland or via a baseflow.

4.2.13 Weirs

Any weirs proposed on Council managed drains shall be specifically designed for the situation considering any Integrated Catchment Management Plan, Catchment Management Plan or Water Impact Assessment requirements, hydraulic design, fish pass and access for maintenance requirements. Early consultation with Council staff is encouraged.

4.2.14 Subsoil Drains

Subsoil drains are installed to control groundwater levels.

Perforated or slotted pipe used under all areas subject to vehicular traffic loads shall comply with NZTA specification F/2 and NZTA F/2 notes. The design for subsoil drains shall include regular inspection and flushing points.

In the absence of any other more appropriate criterion the design flow for subsoil systems shall be based on a standard of 1mm/h (2.78 L/s/ha).

Subsoil drainages servicing private property will not be accepted for vesting by Council.

4.2.15 Soakage Devices

Soakage devices such as soak pits and soak holes, filter strips, infiltration trenches and basins, permeable paving, green roofs, and tree pits shall be considered for managing stormwater from roofs, accessways, parking areas, and occasionally roads.

The ability of the ground to accept stormwater can vary enormously within soakage areas, even within individual properties. Therefore, at least one percolation test will

normally be required for every soakage device that is constructed and this should be done where the soakage device is likely to be placed.

Exceptions to the above expectations for testing are:

- Extensions to car parking or paving of less than 50m² may use a rock filled trench along the lower edge of dimensions 0.5m wide and 0.5m deep;
- Soakage device for an impervious area less than 40m² can use nominal soak holes.

Note: larger areas may not use multiples of these nominal designs.

Soakage (with storage) is expected to be utilised where soakage results are >150mm/hr as determined using the Building Code E1 Method.

Soakage is allowed in soils with lower soakage, however specific engineering design is required for soils with low permeability rates.

Specific matters to be considered in soakage system design include:

- a) Capacity adequate for a 10 Year ARI event, maximum potential impermeable area and located in such a way to maximise the collection of site runoff
- b) Soakage devices shall be located away from overland flow paths
- c) Rate of soakage determined through a soakage test with an appropriate reduction factor (at least 0.5, as per NZS 4404) applied to accommodate loss of performance over time
- d) Secondary flows shall be provided for the water which will follow during events that exceed the design capacity of the soakage device
- e) Confirmation that the soakage system will not have an adverse effect on surrounding land and properties from land stability, seepage, or overland flow issues
- f) Pre-treatment device to minimise silt ingress
- g) Interception of hydrocarbons
- h) Access for maintenance
- i) Soakage devices must not be located close to buildings or boundaries
- j) A clearance of 3m is generally required, but this can be reduced to 1m for porous paving, or can be reduced to 1.5m where the neighbouring property is required to have a 1.5m setback to any new building. Setbacks to roadside boundaries shall be 0.5m (to avoid fence footings). Further encroachment will require a site-specific design (including PS1 certification) to be carried out.
- k) Soakage devices should not be located beside retaining walls
 - (i) For walls less than 2m high, the clearance must not be less than a horizontal distance that is equal to the retaining wall height plus 1.5m, unless a site-specific design (including PS1 certification) is carried out.
 - (ii) For walls higher than 2m, a site specific design is required.
- l) Soakage devices must not be located within 2m of public wastewater pipes or 1m of private wastewater pipes.
- m) Soakage devices must not be positioned on unstable slopes
- n) A discharge permit may be required from the Waikato Regional Council.

4.2.15.1 Recharging of Peat

Stormwater management on peat soils provides a special design challenge that needs to be addressed with care.

Council defines peat soils as those with greater than 300mm of peat between 0.5m and 4.0m depth of the natural ground surface.

Defining the right amount of soakage is very site specific and the release of the stormwater into the peat/soil will need to be considered on a site by site basis. For small developments an acceptable solution will be the provision of a single well liner to take the runoff from each 50m² of roof area. This will then have high level provision for overflow discharge to the Council reticulation or an overland flow path as shown in Drawing D4.5.

4.2.16 Stormwater Treatment Device Selection

There are a number of treatment and detention options available, the preferred solution will either be identified in an approved Integrated Catchment Management Plan/Catchment Management Plan/Water Impact Assessment, in Council's standard practice notes, or via Table 4-15.

The Hamilton City Council Three Waters Management Practice Notes provide details of the implementation of management solutions on individual lots. The practice notes contain acceptable means of complying with requirements for at source water efficiency measures. The practice notes are available on the HCC website¹⁸. Refer to the Overview practice note in the first instance.

Design shall follow the guidance provided in Auckland Council document TP10¹⁹. Care should be taken to ensure that the Council's specific requirements as set out in this Section take precedence over TP10.

If Council is to be ultimately responsible for maintenance it shall be located on land owned by, or to be vested in Council or protected by an appropriate easement in favour of Council.

Council encourages early consultation between the Developer and Council staff to achieve mutually beneficial design outcomes. Council seeks design outcomes that meet functional requirements whilst avoiding poor visual results.

As discussed in Section 4.2.3.1, some Councils require at source stormwater/rainwater treatment for all new buildings in accordance with good practice and their District Plan. These are referred to as 'water efficiency measures' and will typically comprise one of the following:

- Soakage
- Rainwater reuse system (rain tank)
- Raingarden
- Protecting permeable surfaces or porous paving
- Detention tank

¹⁸ <http://www.hamilton.govt.nz/our-council/council-publications/manuals/Pages/Three-Waters-Management-Practice-Notes.aspx>

¹⁹ This will be replaced by the WRC's Waikato Stormwater Management Guideline (May 2018)

Figure 4-3 below illustrates the decision tree for selecting different types of treatment devices based on development scenario. Consideration of operations and maintenance costs is critical, which leads to a preference of a single public centralised treatment device.

Table 4-15 presents the preferences for treatment in addition to the private assets delivered in accordance with the District Plan and good practice. This includes performance capabilities and design considerations. Level 1 represents the Councils preference for centralised stormwater treatment wetlands to meet water quality and quantity outcomes. In instances where this is not feasible or desirable, developers may propose an alternative solution. Levels 2 to 4 include distributed treatment stormwater treatment elements which can be designed to achieve the required treatment through a more distributed treatment train approach.

Stormwater Management

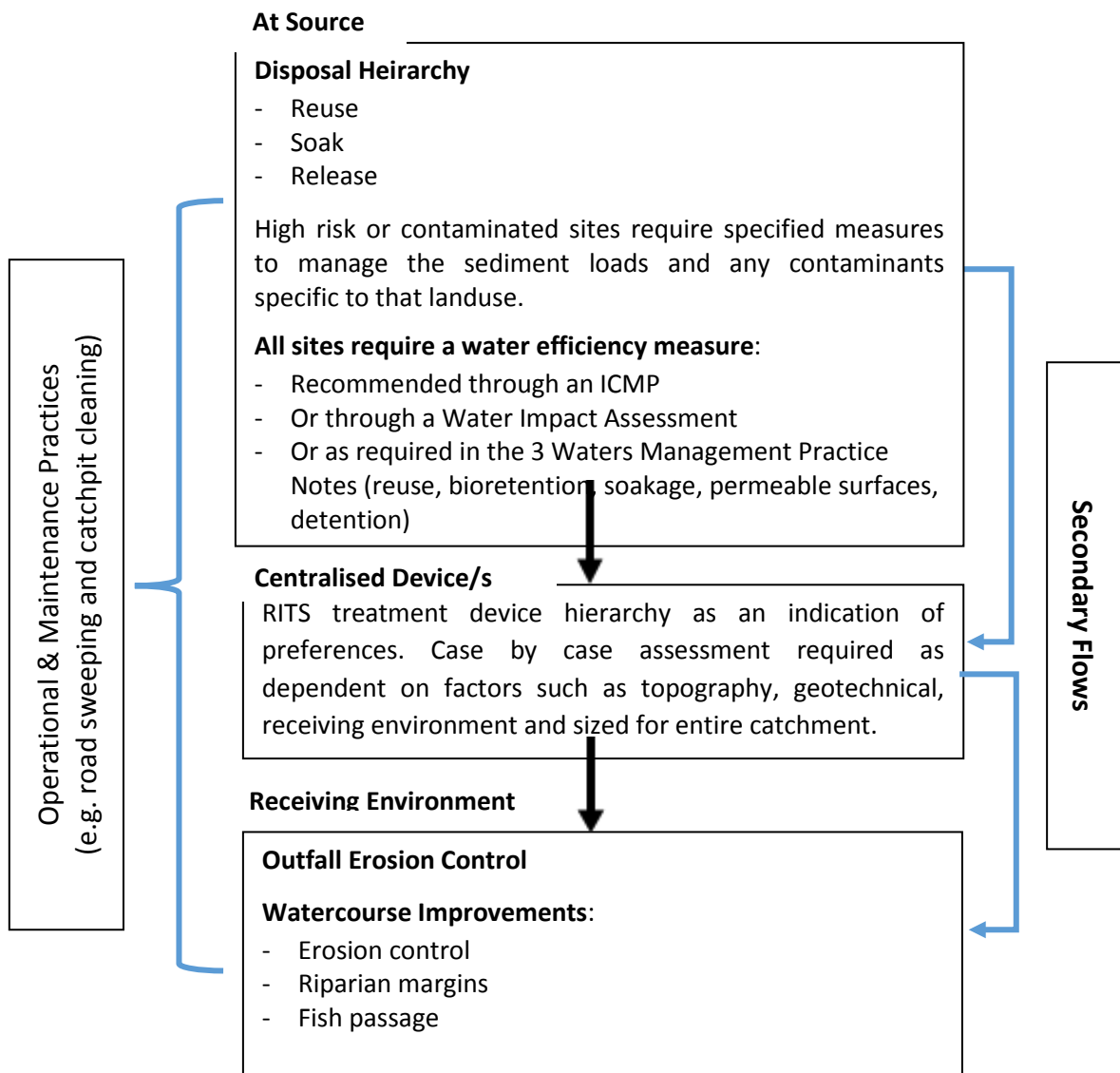

Drawing 4-2: Selection of treatment device based on development scenario

Table 4-15: Vested treatment device preferences

LEVEL	DEVICE	PERFORMANCE			DESIGN PREREQUISITES
		TRE. ²⁰	DET.	RET.	
1	Wetland (Catchment area > 8ha)	✓	✓		<ul style="list-style-type: none"> Suitable location downstream (offline to main channel and preferably overland flow path also, no significant topographical constraints, and can physically fit in the space available including batters). Has a contributing catchment size greater than 8 hectares. Includes impermeable base (either verified in-situ material or imported liner) Access for safe and practical maintenance can be provided. If wetlands are undersized for their catchment due to site constraints, the developer needs to undertake inundation frequency/duration analysis to ensure that vegetation will not be drowned.
2	Wetlands (Catchment area < 8ha)	✓	✓		<ul style="list-style-type: none"> Suitable location (offline, no significant topographical constraints, can physically fit in the space available including batters). Has a catchment size < 8 hectares. Includes impermeable base (either verified in-situ material or imported liner) Access for safe and practical maintenance can be provided.
	Raingarden (Catchment area > 0.5ha)	✓	✓	✓	<ul style="list-style-type: none"> Suitable location (able to be constructed offline to avoid peak flows, can physically fit in the space available including batters). No significant topographical constraints; e.g. positive drainage towards device and able to drain outflows. Designed to ensure engagement of full filter media surface. Space for pre-treatment if catchment has a high sediment load. Includes impermeable liner when in proximity to roads/structures or as part of stormwater harvesting scheme. Access for safe and practical maintenance can be provided.
	Swale (outside road corridor)	✓	✓		<ul style="list-style-type: none"> Suitable location (no significant topographical constraints, sufficient length for treatment, adequate space available). Must be supported by geotechnical testing to confirm in-situ saturated hydraulic conductivity where design includes infiltration Underdrains are required for slopes < 2%. Demonstrates required velocity and hydraulic retention time to support function. Pedestrian and vehicle crossings are provided. Access for safe and practical maintenance can be provided. Pollutant/hydrologic performance reflected in design of any downstream devices where used in treatment train

²⁰ See Note at end of table for definitions

LEVEL	DEVICE	PERFORMANCE			DESIGN PREREQUISITES
		TRE. ²⁰	DET.	RET.	
3	Raingarden (Catchment area < 0.5ha)	✓	✓	✓	<ul style="list-style-type: none"> Suitable location (able to be constructed offline to avoid peak flows, no significant topographical constraints, can physically fit in the space available including batters) Space for pre-treatment if catchment has a high sediment load Includes impermeable liner when in proximity to roads/structures or as part of stormwater harvesting scheme. Access for maintenance can be provided
	Proprietary Gross Pollutant Trap with underground storage tank.		✓	✓	<ul style="list-style-type: none"> Suitable location within the road corridor (free of services, exfiltration (where relevant) won't compromise structural performance of pavements.). Safe and practical access for cleanout and maintenance is provided Designed as pre-treatment in treatment train based on contaminant loadings of particular landuse
	Porous concrete parking bays	✓		✓	<ul style="list-style-type: none"> Designed to reduce rainfall runoff at source Must be supported by geotechnical testing to confirm in-situ saturated hydraulic conductivity Not suited to high sediment load landuses Not suited in aquifer recharge zones without pre treatment Must be designed to accommodate vehicle loadings Access for safe and practical maintenance can be provided. Pollutant/hydrologic performance reflected in design of any downstream devices where used in treatment train. To be used only when suitably certified installers can do the work.
	Rain water tank	✓	✓	✓	<ul style="list-style-type: none"> Designed to reduce rainfall runoff at source and reduce potable demand Fit for purpose reuse demand based on constant and variable uses Design based on local rainfall runoff data Sized based on roof catchment to provide acceptable reliability of supply Storage of harvested water typically limiting factor Pollutant/hydrologic performance reflected in design of any downstream devices where used in treatment train
4	Proprietary chamber filter	✓			<ul style="list-style-type: none"> Access for cleanout and maintenance is provided without impeding traffic flow Tie in point to system is low enough to meet operational head loss requirements Designed as pre-treatment in treatment train based on contaminant loadings of particular landuse

LEVEL DEVICE	PERFORMANCE			DESIGN PREREQUISITES
	TRE. ²⁰	DET.	RET.	
Proprietary catch pit filter	✓			<ul style="list-style-type: none"> • Tie in point to system is low enough to meet operational head loss requirements, access for maintenance is provided without impeding traffic flow • Designed as pre-treatment in treatment train based on contaminant loadings of particular landuse
Swale (inside road corridor)	✓	✓		<ul style="list-style-type: none"> • Access for safe and practical maintenance is provided • Safety and access issues have been addressed • Vehicle and pedestrian crossings are provided • Infiltration swales are not suitable within the road corridor • Pollutant/hydrologic performance reflected in design of any downstream devices where used in treatment train

Note: Tre. – Treatment: the provision of water quality treatment (refer Table 4-3).
 Det. – Detention: the provision of flow mitigation and flood control is required.
 Ret. – Retention: to enable volume reduction which assists with flow mitigation and flood control.

When considering the above, always take into account standard effects, assessment and planning protocols e.g. will the device cause flooding, off site adverse effects, and identify and protect the secondary flow path.

4.2.16.1 Safety Requirements

- a) The treatment and detention devices shall not compromise the safety of adjacent properties or the community. CPTED (Crime Prevention through Environmental Design) principles (refer to Landscape Section, Clause 7.2.2) are to be incorporated.
- b) Embankments must be permanently planted if the slope ratio is steeper than 1 (vertical) to 4 (horizontal).
- c) Any embankment that the Council determines is either too inaccessible or unsafe for regular grass mowing shall be permanently planted.
- d) A safety bench shall be provided between the normally dry water level and the deep water where deep pools of greater than 0.9m are proposed. The safety bench shall be between 0.3m and 0.5m below normal water level and between 0.5m and 1.0m wide. Additional safety bench(s) are required each 5.0m where slopes greater than 1:3 lead to a deep water pond. Stabilise aquatic and safety benches with emergent wetland plants and wet seed mixes.
- e) Any part of stormwater structures having either a vertical drop of over 0.9 m or the ability to fall directly into standing water of depth greater than 0.9 m shall be fenced in 50% permeable format (e.g. pool fence) and otherwise compliant with the Building Act. Wetlands are expected to be designed as per section 4.2.17, so that there is no requirement for fencing. Council prefers such unfenced wetlands to steeper wetland that require fencing as these are also generally less costly.
- f) Fencing across overland flow paths is controlled by the relevant District Plan and requires approval by Council.

4.2.17 Constructed Wetlands

When designing wetlands, the following should be considered.

4.2.17.1 Location considerations

Table 4-16: Location considerations

ITEM	CONSIDERATION
Drainage	Ensure that the target catchment is able to drain to the wetland preferably through a single inlet with an invert, which enables the footprint to be achieved with efficient earthworks. Ensure that the proposed outlet level (i.e. invert of receiving drains and/or watercourse) will enable drawdown of the wetland to at least the normal water level (NWL).
Discharge	Ensure that the discharge is suitable for the receiving environment. This includes consideration of appropriate mitigation targets for flow attenuation and water quality, including temperature.
Maintenance access	Consider how machinery will get access to the wetland for construction and maintenance, in particular clean out of the sediment forebay.
Pre-treatment	Ensure that forebay is incorporated into the design unless approved catchment pre-treatment is provided.
Offline	Vegetated wetlands shall be placed offline to the main channel for peak flows. Allowance must be made for appropriate high flow diversion prior to the wetland.
Draw down	Wetlands must be free draining by gravity to at least the NWL. Where possible allowance shall be made for draining the wetland entirely (or as much as possible) for maintenance purposes.
Imperviousness (wetland lining)	Wetlands must be impermeable to at least the NWL with an appropriate impermeable liner to prevent water losses. Lining can be either compacted clay (<i>in situ</i> or imported) or synthetic products such as geo-synthetic clay liners (GCL) or HDPE in accordance with manufacturer's specifications.
Water table	Where wetlands are to be constructed above shallow water tables, attention must be given to constructability and issues such as flotation of the liner. Construction timing (when groundwater recedes) or synthetic liners may be required.
Underground services	Contact utilities (power, water, gas) and check with the council for locations of underground services in the area. If underground services are near or in the proposed wetland location, they shall be relocated clear of the site or the wetlands re-sited.
Setback	Ideally wetland areas should be located at a 1 m minimum from property boundaries. Wetlands should not be located within a 1V:1H plane taken from the toe of any retaining wall.
Overhead setback	If trees are included around the wetland perimeter, consideration should be given to overhead setbacks to ensure that mature trees do not interfere with utilities such as power lines. Relevant utility managers must be consulted for up to date guidance on setbacks etc.
Contaminated land	Contaminated land may pose a financial risk due to the potentially large amount of material to be disposed of during construction of wetlands. Potential land contamination must be considered at the concept design phase and investigations undertaken.

ITEM	CONSIDERATION
Slope stability	To minimise the risk of slope failure, wetlands should be placed greater than 15 m away from non-engineered slopes 15% or greater and consideration must be given to the risks of slope instability from saturating the toe of slopes. Where required, impermeable lining may be required to extend above the NWL to the top of operational water levels. Geotechnical advice shall be sought where appropriate.
Expansive soils	Wetlands placed within 5 m of a structure should be lined entirely to the top of operational water level. Structures include buildings (residential and commercial), retaining walls (>1m height), trafficable roads/rail, utility infrastructure (i.e. cell towers, transmission pylons and masts), playgrounds, private boundary fences and swimming pools.

Wetland bathymetry must be configured to manage flow paths, water depths and velocities so that the required level of treatment is achieved while remaining resilient to the frequency and duration of inundation. The intention is to prevent high velocity flows forming and ensuring robust plant communities can develop.

4.2.17.2 Wetland design requirements

Table 4-17: Wetland design requirements

ITEM	DESCRIPTION
Water Quality Volume (WQV)	Required where the wetland is providing a water quality function.
Extended detention volume (EDV)	Required where wetland is discharging to a natural or modified watercourse and needs to mitigate potential downstream erosion, scour and ecological effects.

Flood mitigation can be provided within the wetland footprint as long as the entire attenuation volume is above the live water level (including EDV). Table 4-3 should be referred to for the requirements for the mitigation of 2, 10 and 100 year peak flows. The design of the wetland hydraulics must protect the wetland from potential scour through the use of appropriately sized flood attenuation outlet controls which support backwater inundation of the wetland and prevent the risk of high velocities through the wetland causing re-suspension of sediments and scour of biofilms. Hydraulic controls to engage the flood attenuation should be positioned within the high flow bypass channel where possible. The design of any flood control aspects must be undertaken by a suitably qualified engineer and designed in accordance with TP 10²¹ or other approved guidance documents.

4.2.17.3 Wetland components to be considered during layout development

The functional components to consider during the wetland layout development are outlined in Table 4-18. Treatment performance is based on the controlled passage of water through the vegetated elements of the wetland and the complex treatment processes these support. Attention to internal batters and longitudinal grade is required to ensure that flows are not concentrated into preferential flow paths which can result in short-circuiting and impaired performance.

Table 4-18: Wetland components to be considered during layout development

²¹ This will be replaced by WRC's Waikato Stormwater Management Guideline (May 2018)

ITEM	DESCRIPTION
Main body	The main wetland body is the bulk of the area of the wetland and provides water quality treatment. The body is sized to provide the WQV and the EDV in conjunction with the forebay. The footprint of the main body can also provide storage for flood mitigation above the top of any extended detention volume level (EDV).
Forebay	The wetland forebay provides coarse sediment removal prior to runoff entering the main wetland body. The forebay should be sized at 15% of the full calculated WQV. The volume of the forebay is therefore counted as part of the WQV.
High flow bypass	A high flow bypass should be included that becomes active when storm events exceed the storage provided by the extended detention zone or inflows exceed the calculated peak water quality flowrate. The high flow bypass should be located before entry to the wetland and must have capacity up to the 100-year event. In instances where flood attenuation is required, this should be primarily supported through hydraulic control within the bypass channel which causes backwatering within the channel and engagement of the wetland flood storage. Where this is not possible and flood flows discharge into the wetland, it must be demonstrated that these flows will not cause excessive scour.
Maintenance access	A 4 m wide maintenance access track must be provided to the sediment forebay to allow access for equipment to dig out the forebay. Vehicle access must be provided to any other hydraulic structures which require periodic inspection.

4.2.17.4 Terms used for wetland sizing

Table 4-19: Terms used for wetland sizing

Item	Description
Zone – Permanent storage zone (PSZ)	The PSZ is the base zone of the wetland main body excluding the forebay area. The water in this zone does not drain out between events (but can evaporate). The PSZ is required regardless of design requirements.
Zone – Live storage zone (LSZ)	The LSZ is the storage zone above the permanent storage zone that provides the EDV and the live portion of the WQV (where applicable). The live storage zone cannot be counted for flood storage during large events. The LSZ is not required if the wetland is only performing a flood mitigation function, the LSZ is optional if the wetland is providing WQV (WQV can be completely provided in the PSZ) and the LSZ is required if EDV is explicitly required.
Zone – Flood storage zone (FSZ)	The FSZ is the storage zone above the live storage zone that provides flood storage only. The FSZ is only required if the wetland is providing flood mitigation.
Depth – Normal water level (NWL)	The NWL is the top of the permanent storage zone. This water level is relatively constant between storm events and can only be reduced by evapotranspiration or controlled drawdown.
Depth – Extended Detention Level (EDL)	The EDL is the maximum height reached by the extended detention volume and is the top of the LSZ.
Depth – Flood water level (FWL)	The FWL is the maximum height reached during 100 year event. The height is determined using routing calculations for the 100 year event. If a high flow bypass is not provided for the 10 year event, these calculations will also need to be performed for this event.

4.2.17.5 Wetland sizing

The sizing of wetlands is based on providing sufficient capacity and conditions to support water quality treatment processes. This is achieved by sizing the wetland based on the calculated water quality volume and then designing the internal bathymetry to provide a mix of shallow and deep marsh zones to sustain robust emergent vegetation. Figure 4-4 provides a schematic representation of an offline linear wetland configuration with key functional zones. Figure 4-5 shows a layout more representative of a larger system which includes maintenance access to the forebay, pipes to independently draw down the sediment forebay, overflow spillway and an optimised flow path to increase the length to width ratio. The sizing and bathymetry of the wetland must be in accordance with Table 4-22.

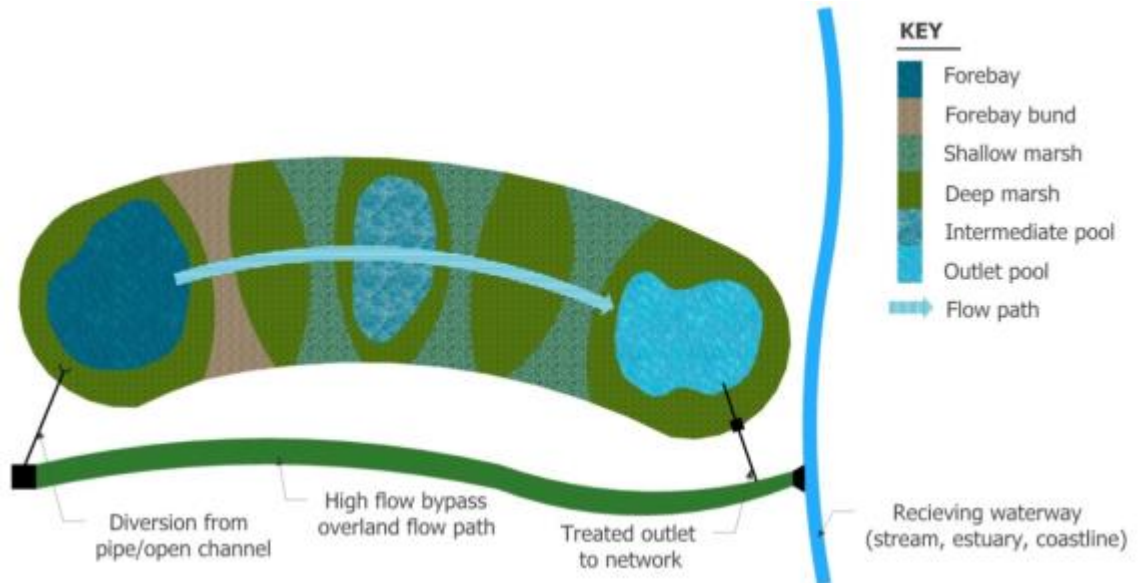

Drawing 4-3: Schematic of Typical Zones in Offline Linear Constructed Wetland

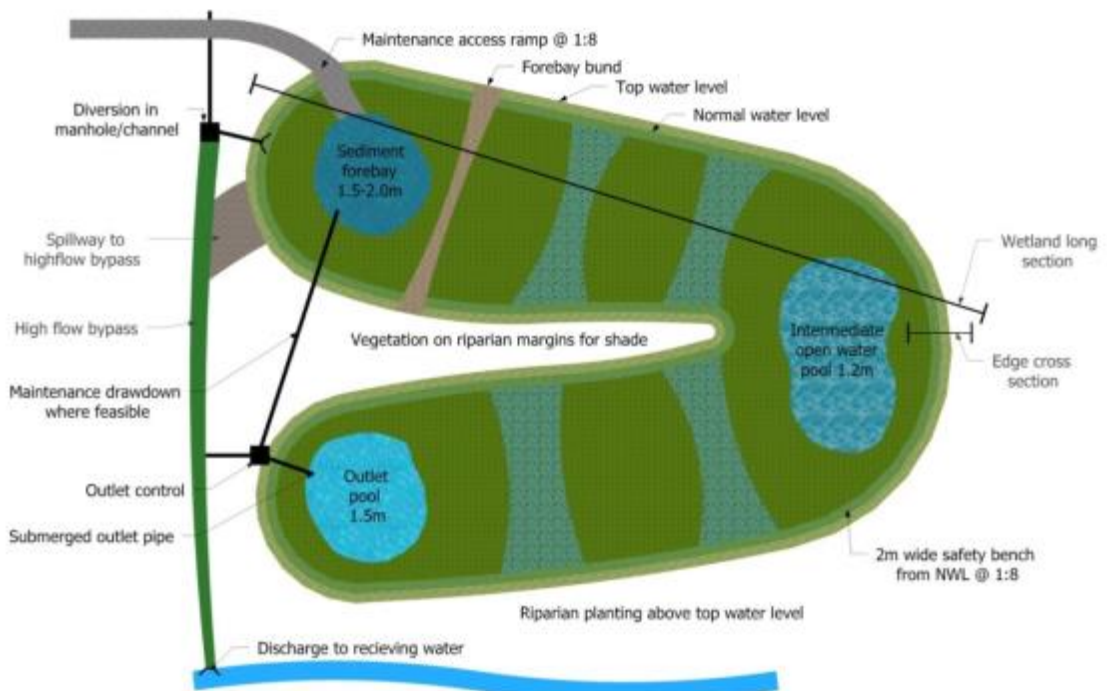

Drawing 4-4: Schematic of Typical Offline Kidney Shaped (sinusoidal) Constructed Wetland

Additional storage for flood attenuation can be provided above the extended detention volume level when required. It is recommended to use the calculation methods outlined in the Auckland Council TP108²², or other agreed methodologies, to calculate water quality volumes and peak flow rates. The following figure provides a schematic of a typical wetland bathymetry:

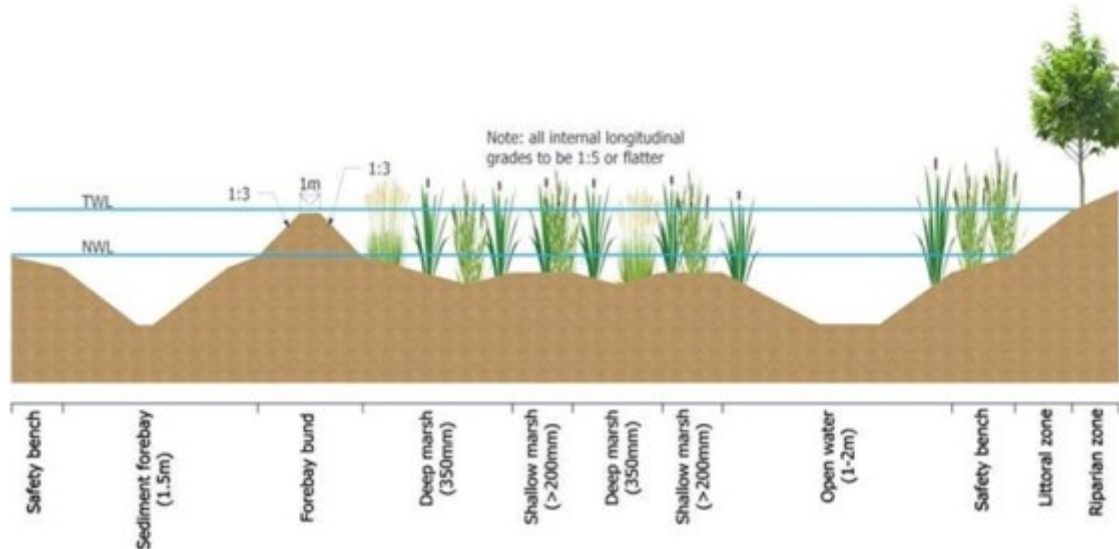

Drawing 4-5: Wetland bathymetry diagram

4.2.17.6 Permanent storage zone design parameters

Design parameters for the permanent storage zone (with and without EDV) are given in Table 4-20. Note that these do not include the forebay area which equates to an additional 10% of the total footprint area.

Table 4-20: Permanent storage zone design parameters for wetland design

EDV REQUIRED	NO EDV REQUIRED	DESCRIPTION
PSZ volume* x 0.75 > 50% of the WQV	PSZ volume* x 0.80 = WQV	More than half the WQV needs to be permanent pool to allow pollutant removal between storm events. If there is no extended detention, the permanent pool should contain the entire WQV.
40% (±5%) PSZ area between 0.00 and 0.20 m deep at NWL	40% (±5%) PSZ area between 0.00 and 0.35 m deep at NWL	Shallow marsh water depths to support emergent macrophyte species provided in table 4-37
40% (±5%) PSZ area between 0.20 and 0.35 m deep at NWL	40% (±5%) PSZ area between 0.35 and 0.50 deep at NWL	Deep marsh water depths to support emergent macrophyte species provided in table 4-37
10% (±2%) PSZ area between 0.35 and 1.20 m deep at NWL	10% (±2%) PSZ area between 0.50 and 1.20 m deep at NWL	Intermediate deep pools within main wetland body provide habitat diversity in the wetland. These should comprise no more than 10% of the main wetland body area.

²² This will be replaced by the WRC's Waikato Stormwater Management Guideline (May 2018)

EDV REQUIRED	NO EDV REQUIRED	DESCRIPTION
10% (±2%) PSZ area between 0.35 and 1.50 m at NWL	10% (±2%) PSZ area between 0.50 and 1.50 m at NWL	Outlet deep pool provides a stilling area before discharge out of the wetland. This should comprise no more than 10% of the main wetland body area.
The length of the PSZ must be at least 5 times the width of the PSZ		Elongated wetlands prevent the risk of short circuiting.
Batters > 0.25 m below NWL maximum 1V:3H	Batters > 0.25 m below NWL maximum 1V:3H	Batters below safety bench extending to variable base
Extending from NWL a 2m wide safety bench must be provided at a maximum slope of 1V:8H		Planted Safety bench must extend around entire perimeter (including forebay) immediately below NWL.
Batters above NWL must be a maximum of 1V:3H		Planted batters above NWL to transition to existing ground.
Emergent Macrophyte vegetation to cover a minimum of 80% of main wetland area at NWL		Dense and diverse plant community critical to support treatment processes. The 80% coverage is supported by the distinct shallow and deep marsh zones

*PSZ volume is adjusted by 0.75 and 0.8 respectively to account for the plant mass volume in this zone.

Figure 4-7 provides a schematic of a typical wetland edge with safety batter and planting to align with depth and inundation.

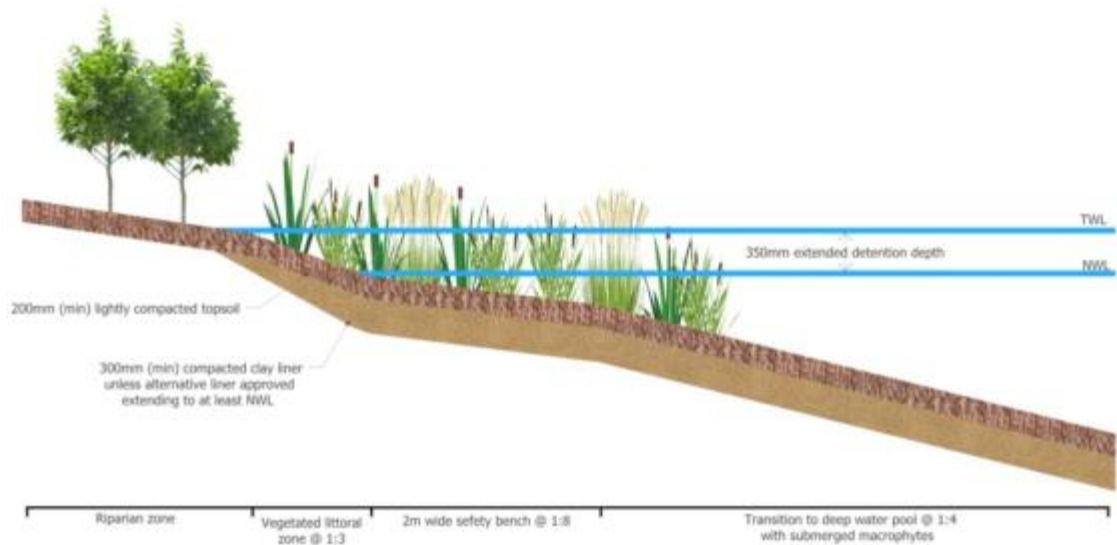

Drawing 4-6: Typical Wetland Edge Detail

4.2.17.7 Live storage zone design parameters

The live storage zone provides frequent, temporary storage of runoff during and immediately after storm events when EDV is required. Design parameters for the live storage zone are given in Table 4-21.

Table 4-21: Live storage zone design parameters

REQUIREMENT	DESCRIPTION
Volume of LSZ = Extended Detention	The extended detention volume needs to be entirely

REQUIREMENT	DESCRIPTION
Volume	provided in the LSZ.
Volume of LSZ > WQV – PSZ volume	Where extended detention is provided, the water quality volume can be distributed across the LSZ and PSZ.
LSZ batters are a maximum of 1V:3H	Batters above normal water level are a maximum of 1V:3H.
TWL < 0.35 m above NWL	The depth of the LSZ should be no deeper than 0.35 m to support healthy plants.
Velocity of flow with depth at: NWL + (EDL – NWL) / 3 during peak flow of WQV event should be less than 0.05 m s ⁻¹	Peak flow assuming a water level 1/3 of the way between NWL and EDL should be less than 0.05 m s ⁻¹ in the WQV event to avoid sediment resuspension and stripping of biofilms.

4.2.17.8 Sediment forebay design parameters

The sediment forebay comprises a deep, low-velocity pool to provide pre-treatment by retaining coarse to medium-sized suspended solids. This enables managed cleanout of these sediments and prevents smothering of the wetland treatment area, thereby increasing wetland longevity. A high-flow bypass is necessary to prevent re-suspension of accumulated sediment by inflows associated with storm events. Design parameters for the sediment forebay are given in Table 4-22.

Maintenance access to the forebay is necessary to allow periodic sediment removal. A track suitable for truck access must be provided. The forebay base is to be lined with compacted crushed rock so that excavator operators can distinguish between accumulated sediment and the forebay base.

The forebay is to be separated from the wetland body with an impermeable bund of compacted earth. The bund should have a 1 m wide crest that is level, set to the elevation of the NWL, and be well vegetated.

Table 4-22: Sediment forebay design parameters

REQUIREMENT	DESCRIPTION
Volume of Sediment forebay = 0.15 x calculated water quality volume (±10%)	The volume of the forebay(s) needs to be in proportion to the full calculated water quality volume to provide sufficient storage for coarse sediments. Multiple forebays are not preferred.
Forebay arrangement	The forebay shall have a surface length to width ratio between 2:1 and 3:1.
Maximum depth of Sediment forebay = 2 m	The forebay needs to be maintainable. Maximum depth is 2m as depths over 2 m can result in special equipment being required for maintenance.
Maintenance bench within 10 m of any part of forebay area	Unless maintenance access is provided into the base of the forebay, all parts of the forebay must be within 10 m of a maintenance bench (hardstand) to ensure the forebay can be dug out without the use of special equipment. The hardstand must be designed to support the loading of a suitable excavator.

REQUIREMENT	DESCRIPTION
Safety bench should be a minimum of 2 m wide and maximum of (1V:8H slope) extending from NWL.	Heavily vegetated safety bench to comprise 2 m wide bench extending from NWL
Batters below NWL maximum 1V:4H	-
Batters above NWL maximum 1V:3H	Batters above the NWL shall have a maximum slope of 1:4 where planted and 1:5 where mowing is required. Note, all wetlands which include EDZ will require planted littoral zones above the NWL.
Forebay Bund	The forebay shall be separated from the main wetland body with an impermeable bund with a crest at (or up to 100 mm below) NWL to support independent drawdown of the forebay water level. The bund can be compacted (with test results to be provided) earth with a formed level crest width of 1 m.
Forebay outlet	Should provide water level control and optimum flow control through the forebay. An overflow weir or weirs with a total length equal to at least 50% of the forebay width is desirable.

Figure 4-8 shows a cross section through a typical bund separating the forebay from the main wetland body.

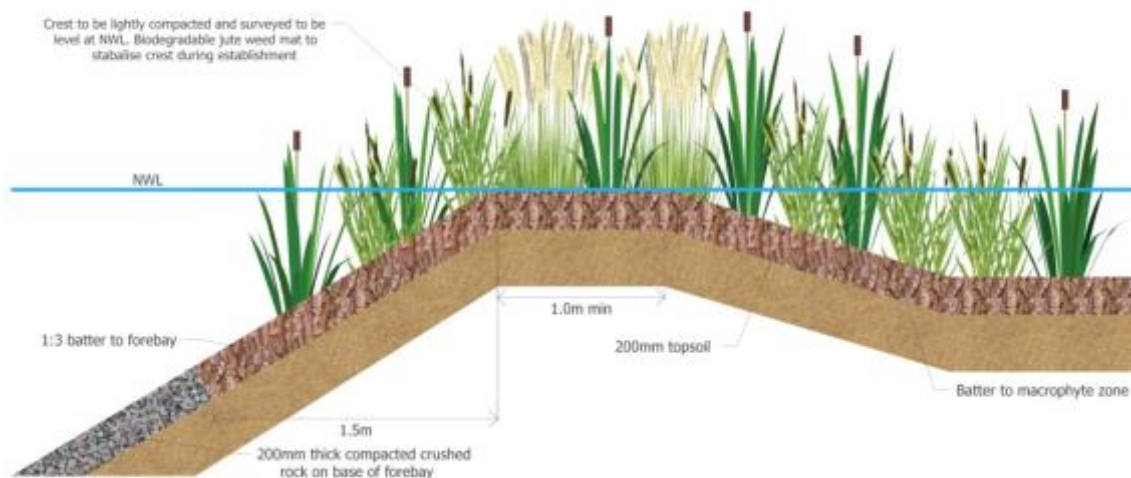

Drawing 4-7: Typical Wetland Forebay Bund Cross Section

4.2.17.9 Wetland inlet design requirements

To protect the wetland from the damaging effects of uncontrolled inflows, inlet design should include energy dissipation to reduce water velocity, prevent erosion around the inlet and provide an even distribution of flow into the wetland. Inlets must discharge to the forebay to ensure pre-treatment. Inlet design requirements are given in Table 4-23. Inlet design should follow the method described in the Auckland Council Technical Report TR2013/018.

Table 4-23: Wetland inlet design requirements

PARAMETER	REQUIREMENT	VERIFICATION METHOD
Inlet pipe	Pipe must meet relevant Council design standards and be appropriately sized for	Approval at time of construction drawings sign off. All pipe sizes to be

PARAMETER	REQUIREMENT	VERIFICATION METHOD
	design flows.	marked clearly on as-built drawing set. Note this document does not cover design of upstream reticulated systems.
Diversion configurations	Any diversion works (including chambers, weirs, orifices and energy dissipaters) must be appropriately designed for the target inflows with consideration for operating hydraulics and head. Tolerances for critical structures must be stated in construction specifications.	As-built verification survey of all critical levels required to ensure diversion will function as intended.
Erosion protection	Design of inlets must consider potential for erosion from all design inflows. Designers must comply with TR2013/018 “Hydraulic energy management: inlet and outlet design for treatment devices”.	Approval at time of construction drawings sign off supported by appropriate calculations.
Construction tolerances	Construction tolerance for the inlet is 5 mm.	As-built survey.

4.2.17.10 Wetland outlet design requirements

The outlet structure controls the water volume and hydraulic regime within the wetland, thereby performing both water quality and quantity functions.

Outlet structure design is determined by site characteristics, desired treatment functions, ecosystem connectivity, and maintenance considerations. Design requirements for outlets are given in Table 4-24.

Where practicable the design should eliminate all falls from heights in and around ponds, wetland and swales.

Where slopes are greater than 1V:1H or vertical drops are > 900mm, barrier planting is to be used to deter access. Where barrier planting is not possible due to the nature of the site, heavy duty pool type fencing is to be installed.

Safe all weather pedestrian access to all outlets into the pond or wetland and to the various levels of the inlet structure or discharge from the pond. This is to allow the operation and maintenance staff safe access during all types of weather conditions.

Hydraulic control should be provided by a removable weir plate. Weirs should be sufficiently narrow to permit a range of water levels within the wetland. A submerged pipe outlet draws off cooler deep water from the outlet pool, thereby reducing temperature-related effects on the receiving environment.

Outlet structures should enable periodic drawdown of the wetland volume for management and maintenance purposes as well as control normal water level in the wetland. Depth control is especially important during plant establishment so that plants are not drowned.

Table 4-24: Wetland outlet design requirements

PARAMETER	REQUIREMENT	VERIFICATION METHOD
Outlet hydraulics	Control outflows to either pass design flows in wetlands without extended detention or support drawdown of extended detention over average of 24-hr period in other cases.	Stage storage and stage outflow calculations to demonstrate hydraulic function
Outlet pool	Include a deep pool (1.5 m deep) at the downstream end of the wetland. Treated flows to be drawn from at least 500 mm below the surface via a pipe connection to the outlet control structure.	Earthworks model based on finished surface. As-built survey to verify finished levels.
Outlet structure	Hydraulic control to be contained within a suitable manhole or open chamber with flow control to define NWL and drawdown of event flows.	Design plans and As-built survey showing all critical levels within tight (5mm) tolerance level)
Outlet location	Outlet control structures must be accessible for inspection and maintenance (i.e. within manhole on batters). Submerged connection to outlet pool is to be included to avoid blockage and draw cooler water.	Design plans and as constructed drawings showing all critical levels within tight (5mm) tolerance level)
Fish passage	Where wetlands are located with fish passage required the design must include provision for passage in a range of typical operating events. Fish passage will not be achievable across the full range of operating conditions while also achieving detention requirements.	Design plans and as constructed drawings
Discharge to receiving environment	All outfalls must comply with relevant Council standards to avoid scour and instability.	Design plans and as constructed drawings
Construction tolerances	Construction tolerance for the outlet is 5 mm.	As-built survey.

4.2.17.11 Wetland spillway design requirements

A high-flow bypass is necessary to divert flows away from the wetland that are greater than the design maximum flow rate. This is to ensure the biological treatment elements, such as macrophytes and biofilms, are not scoured by high-velocity flows and that accumulated sediments are not re-mobilised. The bypass must be placed upstream of the sediment forebay.

Spillway design requirements are given in Table 4-25.

Table 4-25: Wetland spillway design requirements

PARAMETER	REQUIREMENT	VERIFICATION METHOD
High flow bypass	Wetlands shall be constructed off line to flows in exceedance of the target treatment flowrate (lesser of calculated WQ flowrate or flowrate based on velocity calculations). This should be supported with an upstream diversion where possible.	Design drawings and hydraulic calculations for all diversion structures and weirs.
Overflow outfalls	Design should include provision for overflow spillways to be engaged at top of extended detention (or maximum standing water head where extended detention not included). Spillways should be located as close to the inlet as possible and be sized to pass maximum flows	Design drawings and hydraulic calculations for all diversion structures and weirs.

PARAMETER	REQUIREMENT	VERIFICATION METHOD
	without excessive head. The outfall must be designed to withstand scour forces.	
Flood flow protection	Where wetlands are located online to large flood flows (including those engaged as part of flood attenuation) the design must consider potential risks in these infrequent events. The design must demonstrate that consideration has been given to all flows up to 100-year event and included suitable spillways or throttled outlets with attenuation storage as part of design.	Design drawings and hydraulic calculations for all diversion structures and weirs.
Construction tolerances	Construction tolerance for the high flow bypass weir is 5 mm.	As-built survey.

4.2.17.12 Maintenance access design requirements

Vehicle access to the sediment forebay is necessary to permit periodic cleaning out of accumulated sediment. Where it is not possible to clean the forebay from the perimeter hardstand, this must include trafficable access into the base of the forebay itself. Light vehicle access to other parts of the wetland must also be available for maintenance purposes. Pedestrian access to the entire perimeter is required for weed control and maintenance of vegetated areas.

Table 4-26: Maintenance access design requirements

PARAMETER	REQUIREMENT	VERIFICATION METHOD
Forebay access	<ul style="list-style-type: none"> a) A 4.0m wide access driveway and platform (as applicable) with all-weather surface suitable for an 8.2 tonne axle weight vehicle, at a grade of less than 1:12 shall be provided b) The excavator working platform shall be level and adjacent to the clean out area c) The excavator working platform shall be no higher than 2.0 m above the base of the clean out area d) If the access path is greater than 50m long then a 3-point turning area for a 10 tonne rigid truck adjacent to device (in addition to the excavator working platform); shall be provided 	Sign off as part of maintenance plan prior to construction approval
Wetland vehicular access	Vehicle access (ute) should be provided to at least 50% of the wetland perimeter (including to all hydraulic structures) along the top of extended detention depth or minor setback for landscape planting. Design of access track must consider other site users where appropriate.	Sign off as part of maintenance plan prior to construction approval
Wetland pedestrian (maintenance staff) access	Pedestrian access must be provided around the entire perimeter including any bunds, structures or hydraulic controls. Preferred access routes should be marked on maintenance plans and maintained free of excessive vegetation growth. All pedestrian paths must comply with the path requirements in the Transportation Section 3.	Sign off as part of maintenance plan prior to construction approval

4.2.17.13 Wetland liner design requirements

Impermeable lining of all wetlands is critical to ensure that the water level is sustained during prolonged dry spells and that the emergent aquatic vegetation is supported. Direct connection with shallow groundwater (through unlined wetlands which intersect shallow groundwater) are not supported due to the inability to reliably maintain water

levels through drought periods and the risk of contamination of groundwater as the primary receiving environment.

In many instances in situ soils at the proposed base level may be suitable for use as the liner with minimal work to form batters and compact the base to form consistent homogeneous liner. The use of in-situ clay material will require pre-construction verification testing and reworking of material. Where in-situ soils are not suitably impermeable, an imported impermeable liner, either natural or synthetic, must be used. Liner design requirements are given in Table 4-27.

Table 4-27: Wetland liner design requirements

PARAMETER	REQUIREMENT	VERIFICATION METHOD
Permeability	Entire wetland (to top of normal water level) must demonstrate a permeability of $1 \times 10^{-9} \text{ m s}^{-1}$ or lower.	Geotech testing at time of construction or approval of synthetic liner prior to installation
In-situ Clay liner option	Minimum 300 mm of well compacted clay required across entire wetland. Approval must be sought for use of in-situ clay material versus imported clay. Where in-situ material is approved for use, all batters shall be completely re-constructed with clay liner to ensure no heterogeneity.	In situ clay material must be tested and approved prior to construction to demonstrate required permeability at 95% standard maximum dry density. Post construction (rolling) testing must confirm 95% standard maximum dry density to at least 300 mm. Minimum testing requirements of 1 test/150 m ² compacted clay material (based on 300 mm uniform liner depth) to be tested by independent geotechnical engineers in accordance with NZ best practice.
Imported Natural Clay liner option	Minimum 300 mm of well compacted clay required across entire wetland including batters. Material must be uniform in composition and constructed to achieve consistent compaction across full area.	Imported clay material must be tested and approved prior to procurement to demonstrate required permeability at 95% standard maximum dry density. Post construction testing must confirm 95% standard maximum dry density to at least 300 mm. Minimum testing requirements of 1 test/150 m ² compacted clay material (based on 300 mm uniform liner depth) to be tested by independent geotechnical engineers in accordance with NZ best practice.
Synthetic liners	Geo-synthetic Clay Liners (GCL) or HDPE (min 1.5 mm) may be suitable in absence of suitable clay source. Approval for material to be provided prior to specification including manufacturers testing and independently verified performance data. Consideration must be given to slope stability on batters to prevent sloughing.	Material to be pre-approved. Installation must be undertaken by approved installer with comprehensive QA procedures to verify integrity of all joins, welds, protrusions and anchoring. Protection of liner post installation critical during subsequent works.

4.2.17.14 Planting and plant selection

Selection of suitable plants for wetlands is critical to ensure sustained performance under a range of conditions. Designers must select species adaptable to the broadest ranges of depth, frequency and duration of inundation.

The following specifications are required:

- Tall perennial species should be planted in preference to non-perennial species. Raupo is not recommended due to die-back in winter and tendency to over dominate other species,

- A diverse assemblage of plants is preferable. Native local species (with seed eco sourced by nurseries) should be used, to represent local vegetative communities and ensure plants are well adapted to local conditions,
- Vegetation should be limited to plants whose root structure will not cause damage to the wetland liner or compromise the structural integrity of any bunds,
- Plants must be supplied as individual plants (i.e. tubestock or pots) and shall not be substituted for manually separated reclaimed clumps or propagation trays cut into units. Plants must be healthy and robust with vegetation extending above the planted water depth,
- Plants should be planted with a desired density of 4 plants/m² to form full coverage of the shallow and deep marsh areas. Water levels should not overtop planted vegetation during the developmental growth phase (water levels can be raised as the plants become well established (2-3 months when planted in spring). Appropriate plant species must be used where there is potential for drying up of the planting zone. Species should be well mixed within their growing conditions to form a natural assemblage where possible.
- Dense, rigid and tall marsh species are best suited within deep marsh zones, whereas tall marsh species with spreading aerial cover are suited adjacent to open water areas.
- Vegetation that provides a high level of shading (including trees, shrubs and reeds / tall sedges) should be planted around and within the wetted margin of the wetland. Tall species with spreading crowns provide aerial cover, especially if located on the northern aspect of a wetland, which assists in reducing elevated temperatures in exposed water bodies. Shade-tolerant herbaceous marsh vegetation to be selected for shaded areas. Care must be taken where synthetic liners are used in areas with permeable in-situ soils. In these instances the use of large tree species should be avoided due to potential instability and risks of damage to synthetic liners.

Plant species types are provided in Table 4-35. Refer to this table for guidance on plant species suitable for use in wetlands.

4.2.18 Swales

The design of swales must be undertaken by suitably qualified designers in accordance with design guidelines. The design of swales must ensure that they are able to convey the required design flows in a controlled manner, are not subject to ongoing erosion/scour and are able to be maintained in a safe and practical manner with consideration given to traffic management. Table 4-28 summarises design requirements for typical swale applications.

Table 4-28: Swale design parameters

PARAMETER	DESIGN REQUIREMENT
CATCHMENT AREA	4HA MAXIMUM
Longitudinal Slope	1.5–3% ideal, but up to 5% is allowed in accordance with the design guidelines. Check dams can be used if slopes between 5-10%.
Lateral slope	0%

PARAMETER	DESIGN REQUIREMENT
CATCHMENT AREA	4HA MAXIMUM
Hydraulic Retention Time	Average of 9 minutes or longer in accordance with TP10 ²³ design guidance
Water Quality Storm Velocity	Lesser of maximum velocity for erosion control or velocity required to meet HRT (or less than 0.8m/s)
Water Quality Storm Depth	The lesser of design vegetation height or 150 mm
Water Quality Storm Manning's Roughness	0.25
Max Velocity in primary system design event	Maximum velocity for erosion control (or <1.5m/s for 10 year 24 hour event)
Max Depth in primary system design event	300 mm deep or 150 mm below top of swale, whichever is less
Primary system event Manning's Roughness	0.03 grassed swale 0.25 vegetated swale
Length	>30 m
Base Width	0.6 – 2 m
Side Slopes	3h:1v planted or 5h:1v if mowing required
Freeboard	0.15 m above 10-yr ARI 24-hr event water level
Check Dams	Required when longitudinal slope >5% to reduce effective grade (2% recommended). Max height equal to WQS design depth (150 mm max)
Level Spreaders	Good practice at all inlets, integrate with Check Dams when longitudinal slope >5% (generally required every 15m)
Under-drains	Required when dry swale slope <2 %
Planting	Base and sides of swale must be planted, refer Drawing 4-8: Stormwater Treatment and Detention Device: Staged Landscape Planting Table 4-35 for details.
Pre-treatment	Required if high contaminant loads to swale.
Vegetation	Grass to be maintained to dense and 100 – 150mm high. Grass species to be able to withstand periodic wetting including submergence. Perennial rye grass or similar. Mowing to be restricted in wet conditions.

Infiltration swale same as above, but without the underdrainage.

Bioretention swale: same as above except:

- Max bottom width up to 7m.

²³ WRC's Waikato Stormwater Management Guideline (May 2018).

- Length to width ratio 5:1.
- High flow bypass to protect wetland plants.

4.2.19 Raingardens

The design of raingardens (often referred to as bioretentions) must be undertaken by suitably qualified designers in accordance with design guidelines. The design of raingardens must ensure that they can detain and treat the required water quality volume, can adequately drain between events through under-drainage and are able to be maintained in a safe and practical manner with consideration given to traffic management. Table 4-29 summarises design requirements for typical raingarden applications.

Table 4-29: Raingarden design parameters

PARAMETER	SPECIFICATION
Landuse	<p>Raingardens are suitable for:</p> <ul style="list-style-type: none"> • Roofs • Residential • Local roads • Commercial (with GPT) • Industrial (within a treatment train) • Arterial roads and highways (VPD > 10,000) (with pre-treatment). <p>Raingardens to be set back from intersections a minimum of 30m and must consider plant selection in consideration with sightlines and public safety.</p>
Performance	<p>Raingardens can provide:</p> <ul style="list-style-type: none"> • Retention storage/infiltration • Sediment removal • Hydrocarbon removal • Bacteria and nutrient removal in some situations • Small storm detention • Metals removal • Temperature mitigation • Nutrient removal (in particular Phosphorous)
Catchment area	<ul style="list-style-type: none"> • For catchments greater than 0.4 Ha specific inlet design is required following this RITS and TR2013/018 from Auckland Council. • Minimise the amount of pervious catchment area draining to the device (in general aim to keep catchment area < 1,000m²). • Minimum raingarden area is 2m².
Location	<ul style="list-style-type: none"> • Devices should be located so that stormwater can flow to the device under gravity without the need for 'bubble up' inlets. • Devices may not be suitable on road reserves with steeper gradients. Incorporating horizontal structures on sloping ground can create pedestrian or vehicular safety hazards.

PARAMETER	SPECIFICATION
Inlet design	<ul style="list-style-type: none"> • Sheet flow with pre-treatment for catchments less than 0.4ha is recommended. • Pre-treatment is required for high contaminant load sites¹ and recommended for normal contaminant load sites². Pre-treatment may be in the form of a grass strip, swale, proprietary device or sediment forebay. • Flow must be slowed at the inlet with flow dispersal techniques such as, gravel verge or rocks. • Concentrated inflow (e.g. kerb cuts) requires energy dissipation or scour protection at the inlet using rock breaching or concrete apron. • Surcharge risers may only be used with specific approval of the Council where positive drainage towards the device surface is not feasible and where blockage will not result in inundation of public/private property. Any surcharge risers must be clearly identified in the operation and maintenance plan.
Outlet Design	<ul style="list-style-type: none"> • Where hydraulic feedback to the inlet is not possible to enable bypass of peak flows, raised overflow manhole (scruffy dome or similar) must be included above EDD. • Unless saturated hydraulic conductivity of underlying soils exceeds that of filter media, underdrainage must be included. • Underdrains are to be sized to pass full WQV peak inflow and comprise perforated PVC pipes (un-sleeved) or similar. • Where retention and infiltration is required, the outlet of the underdrain shall be raised above base to provide inter event reservoir.
Design event	<p>Raingardens may be designed to provide:</p> <ul style="list-style-type: none"> • Treatment for the WQV (minimum 2% of catchment area) • 24mm detention storage (minimum 5% of catchment area)
Extended detention depth (EDD)	<p>Where possible Raingardens shall be designed with an extended detention depth of 200 – 300mm above the bed of the mulch layer.</p>
Vegetation	<p>Plants should be able to tolerate periods of inundation and longer dry periods, be perennial and have deep fibrous roots. They need to be suited to free draining soil and natives are preferred.</p>
Planting media	<p>Raingarden media should meet the following specifications:</p> <ul style="list-style-type: none"> • Minimum depth 500mm. • Saturated Hydraulic Conductivity: 50 to 300 mm hr⁻¹. • Plant available water: 100 mm • Organic matter: 10% - 30% by volume • pH range: 6.5 – 7.5+ • Electrical Conductivity: < 2.5 dS m⁻¹ • Total Nitrogen: < 1,000 mg kg⁻¹ • Total phosphorus: Leachate testing required if > 100 mg kg⁻¹ • Total Copper: ≤ 80 mg kg⁻¹ • Total Zinc: ≤ 200 mg kg⁻¹ • Media sources: From a clean source (no waste products)
Mulch	<ul style="list-style-type: none"> - 100 – 150mm non-floating mulch layer. - 75% organic mulch with 25% compost mix.
Transition layer	<p>Clean, well graded sand with minimal fines, 100 mm thick, void ratio 0.3.</p>
Drainage layer	<p>5-10mm washed drainage metal (pea metal) or similar, 300mm minimum thickness.</p>

PARAMETER	SPECIFICATION
Underdrain	<ul style="list-style-type: none"> Under drain should be perforated PVC or similar pipe, minimum grade 0.5%. Minimum diameter 100mm for up to 10m² rain garden, 1x 150mm dia or 2 x 100mm dia for 10m² – 20m² rain garden area. Specific design is required for rain garden larger than 20m². One drain per 3m width of rain garden.
Impermeable liner	<ul style="list-style-type: none"> Impermeable liners may be used where the raingarden is connected with stormwater harvesting scheme or site conditions require lining Linings need to respond to site specific requirements (eg. unstable ground or steep slopes) and must consider adjacent services, adjacent trees, slope stability, buildings (including footings) and road substrates.

1 Pre-treatment must remove high contaminant loads before flow enters the Raingarden, refer Table 4-4.
2 Pre-treatment reduces maintenance frequency and provides protection for unexpected sediment loads.

4.2.20 Hydrodynamic Separator

Typical specifications for the proprietary hydrodynamic separator are provided in Table 4-30. Only products on the acceptable products list in Section 8 are acceptable.

Table 4-30: Hydrodynamic separator specifications

PARAMETER	SPECIFICATION
Landuse¹	<ul style="list-style-type: none"> Highly trafficked roads (> 10,000 VPN) Car parking in commercial areas New developments Construction sites Vehicle maintenance yards Industrial and commercial facilities (i.e. Airports, mechanics, truck stops, shopping malls, restaurants, supermarkets).
Catchment size	The maximum catchment size is 50 hectares
Performance	<ul style="list-style-type: none"> Gross pollutant removal Course sediment removal Some fine sediment removal Floatables, oil and grease removal Must be part of a treatment train
Sizing	<ul style="list-style-type: none"> Generally treats the first flush (calculated water quality volume). Flows exceeding the device capacity are designed to bypass the system using an upstream manhole. Consult manufacturer's guidance for detailed sizing information.

1 Although the listed land uses are suitable, locate the device outside of live traffic lanes.

4.2.21 Underground Storage

Typical specifications for underground storage devices are provided in Table 4-31.

Table 4-31: Proprietary underground storage specifications

PARAMETER	SPECIFICATION
Landuse	Non-trafficked areas, e.g. landscapes. Carparks (vehicles up to 2,500kg gross mass. Trafficked areas, vehicle greater than 2,500kg gross mass.
Performance	Depending on the design, the storage tank can provide: Retention (infiltration) storage and/or Detention storage. Must be part of a treatment train.
Device Type	Public owned Underground Storage Preference Order: 1) Porous manhole(s) with filter cloth 2) Open arch type soakage chamber(s) with filter cloth 3) Cell structure type(s) with filter cloth 4) Rock or approved drainage media typewith filter cloth
Sizing	Provide extended detention for the 24 mm event and flood attenuation if required. Consult manufacturer’s guidance for detailed sizing information. Depending on the device location minimum cover depths will apply.
Location	Public owned Underground Storage Preference Order: 1) Parking bays 2) Footpath 3) Berm between kerb and footpath

4.2.22 Catchpit Filter System

Table 4-32 summarises design requirements for typical catchpit filter system (CFS) applications. As systems are manufacturer specific, general specifications have been provided. Only products on the acceptable products list in [Section 8](#) are acceptable.

Table 4-32: Catchpit filter specifications

PARAMETER	SPECIFICATION
Landuse	<ul style="list-style-type: none"> • Shopping malls • Schools • Carparks • Roads
Catchment area	<ul style="list-style-type: none"> • Less than 1 Ha and comply with Clause 4.2.3.4
Performance	<ul style="list-style-type: none"> • Gross pollutant removal • Some coarse sediment removal • Must be part of a treatment train
Sizing	<ul style="list-style-type: none"> • Installed into a curb inlet or catchpit and can be customized to meet specifications. • High flows are designed to bypass. • Drainage design should account for loss of inlet capacity to system.

4.2.23 Underground Chamber Filter

Table 4-32 summarises design requirements for typical chamber filter applications. As systems are manufacturer specific, general specifications have been provided.

Table 4-33: Underground Chamber filter specifications

PARAMETER	SPECIFICATION
Land use	<ul style="list-style-type: none"> All land use excluding heavy industrial. For heavy industrial a treatment train may be required to meet water quality targets
Catchment area	<ul style="list-style-type: none"> Recommended less than 10 Ha
Performance	<ul style="list-style-type: none"> Gross pollutant removal 75% TSS and metals removal
Sizing	<ul style="list-style-type: none"> Manufacturer specified sizing designed to capture 10 mm hr⁻¹ (based on flow rate to capture similar annual volume to WQV wetland) Preferably installed in an offline configuration Internal bypass required if installed online

4.2.24 Planting and Aesthetic requirements

- a) Aesthetic design elements shall be in keeping with local character. Consider:
 - (i) Integrating planting into the wider environment such as streetscape and/or park setting so that the planting is seamless (where this is desired)
 - (ii) Extending the footpath into wetland area as a boardwalk
 - (iii) Making the wetland shape and edges aesthetically appealing
 - (iv) Planting is intended to mimic natural succession by having bands or groups of different plant species growing in a sequence of conditions from open water to boggy areas and up to drier ground.
- b) Landscaping shall:
 - (i) Comply with engineering requirements
 - (ii) Minimise ongoing maintenance
 - (iii) Improve stormwater water quality discharge
 - (iv) Retain existing bush areas and tree stands where possible
 - (v) Become a community asset and positive visual amenity
 - (vi) Provide, where possible, forage and habitats for native flora and fauna
- c) Planting plans to be submitted to Council for approval:
 - (i) Plant species allocations are to be specific to soil type and conditions, site topography and exposure, post-development groundwater table levels and alignment with local indigenous native plant species. Plant species are to be indigenous to the Waikato Region, although native New Zealand grasses are permitted. Likewise, plants are to be eco-sourced where possible from the Waikato Region.
 - (ii) Of the vegetation mix in wetlands at least 10 percent and no more than 25 percent must be staked 1.5 m high grade trees.
 - (iii) Vegetatively shade inflow and outflow channels as well as those areas of the wetland with a northern and eastern exposure to reduce thermal warming.

4.2.24.1 Planting Zones

The following planting zones (Table 4-34) define the planting regimes within detention and treatment devices. They are intended for wetlands but can be applied to other

devices and are based on vegetative tolerances to wet/damp roots and frequent/infrequent inundation. Refer to **Error! Reference source not found.** and Table 4-35 for approved plant species.

Due to site conditions and detention and treatment device configuration it may not be feasible for all Planting Zones to be used within a device. Consult with Council to confirm the applicable Planting Zones.

Table 4-34: Planting Zones

ZONE	DESCRIPTION
Submerged Zone	This area is where the pond ground surface is capable of being permanently submerged and where the plant roots may be permanently water logged
Shallow Marsh Zone	This area is likely to be submerged or partially submerged in a 2 Year ARI return storm event
Littoral Edge Zone (between NWL and TWL)	This is the planting zone between the Shallow Marsh Zone and Riparian Zone where plants may be occasionally submerged (in storm events more severe than the 2 Year ARI return period storm). Plants are able to withstand inundation for short periods of time
Riparian (above TWL)	This planting zone is generally above the spillway level. Plants are able to sustain damp roots for periods but should not be fully inundated

4.2.24.2 Plant Sourcing and Grade

Plants are to be eco-sourced from the Waikato Region where possible, from reputable nursery stock with grades to be of good health and form that minimize potential mortality rates. It is strictly prohibited to transplant vegetation from existing wetlands and other such environments.

Plant grades are to be of a suitable size to ensure vegetation establishes rapidly with minimum mortality rates and/or replacement requirements. Refer to **Error! Reference source not found.** and Table 4-35 for the minimum plant grades. Trees are to be a minimum grade of 1.5m high.

4.2.24.3 Species Selection

Species are to be selected with regard to good conformation, healthy robust root systems and low maintenance shall comply with Council’s planting policies.

Planting species are to be selected according to the planting list indicated in

Table 4-35 and corresponding site topography and ecology unless there are more suitable plants according to site conditions and/or local ecology. Where trees, shrubs and groundcovers are to be planted within a transportation corridor, reference shall be made to the [Landscaping Section](#), Clause 7.2.9.

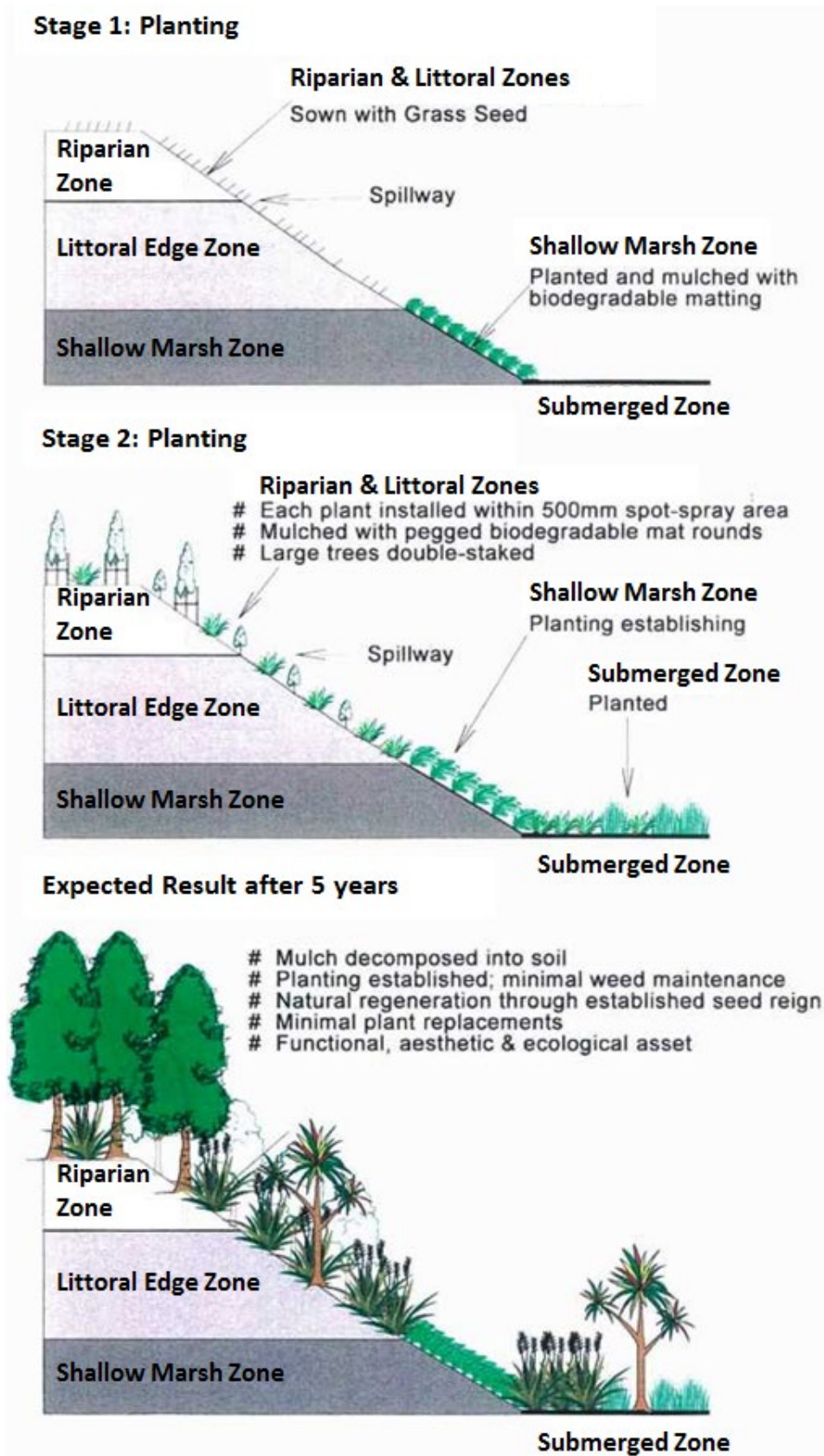

Drawing 4-8: Stormwater Treatment and Detention Device: Staged Landscape Planting

Table 4-35: Approved Plant Species

Botanical Name	minimum centres (m) **	Minimum Grade	Type	Applicable PSD	Pond & Wetland	Riparian Zone	Littoral Edge Zone	Shallow Marsh Zone	Submerged Zone (Depth range in bold)	Rain Garden	Vegetated Swale	Vegetated Filter	Tolerance	Peat Soil	Frost	Wet/ Moist	Dry	Wind	Light Requirements	Full Sun	Part Shade	Full Shade	Characteristics	Rapid Growth	Nurse Plant	Bird Forage
Apodasmia similis	1	RT	Medium Rush																							
Aristotelia serrata	2	5	Small Tree				X																			
Astelia grandis	1	3	Medium Shrub																							
Austroderia fulvida	1	RT	Small Grass																							
Austroderia toe toe	1	3	Medium Grass																							
Baumea articulata	1	RT	High Rush						0.30m																	
Baumea rubiginosa	1	RT	Low Rush																							
Baumea teritifolia	1	RT	Rush																							
Blechnum minus	1	3	Fern																							
Blechnum novae-zelandiae	1	3	Medium Fern																							
Carpodetus serratus	2.5	5	Medium tree																							
Carex dispacea	1	RT	Sedge				>																			
Carex dissita	1	RT	Sedge																							
Carex gaudichaudiana	1	RT	Sedge																							
Carex geminata	1	RT	Sedge				>	0.05m																		
Carex maorica	1	RT	Sedge																							
Carex secta	1	RT	Sedge				>	0.05m																		
Carex virgata	1	RT	Sedge				>																			
Coprosma grandifolia	1	5	Tall Shrub				X																			
Coprosma 'Hawera'	0.5	3	Groundcover																							
Coprosma kirkii 'Minogue'	1	3	Groundcover																							
Coprosma propinqua	1	5	Tall Shrub				X																			
Coprosma rhamnoides	1	5	Tall Shrub				X																			
Coprosma rigida	1	5	Tall Shrub				X																			
Coprosma robusta	1	3	Tall Shrub				X																			
Coprosma tenuicaulis	1	5	Tall Shrub				X																			
Cordyline australis	1	3	Small Tree				X	0.10m																		
Cyathea dealbata	1	8	Tree Fern				X																			
Cyperus ustulatus	1	3	Medium sedge																							
Dacrydium dacrydioides	2.5	1.5m High	Tall Tree				X																			
Dianella nigra	1	5	Small Shrub																							
Dicksonia fibrosa	1	8	Tree Fern				X																			
Dicksonia squarrosa	1	8	Tree Fern				X																			
Dodonea viscosa	2	5	Small Tree				X																			
Eleocharis acuta	1	RT	Low Rush						0.20m																	
Eleocharis sphaelata	1	RT	Low Sedge						0.40m																	
Fuschia excorticata	2.5	1.5m High	Medium Tree				X																			
Griselinia littoralis	2.5	1.5m High	Medium Tree				X																			
Hebe diosmifolia	1	3	Medium Shrub																							
Hebe parviflora	1	3	Medium Shrub																							
Hebe stricta	1	3	Medium Shrub																							
Hebe 'Wiri Cloud'	0.5	3	Small Shrub																							
Hebe Wiri Mist	0.5	3	Small Shrub																							
Hoheria sextylosa	2	5	Small Tree				X																			
Isolepis reticularis	1	RT	Sedge																							
Juncus edgariae	1	RT	Rush																							
Kunzea ericoides	2.5	3	Tall Tree				X																			
Leptospermum 'Crimson Glory'	1	3	Small Shrub																							
Leptospermum scoparium	2	3	Small Tree				X																			
Libertia ixioides	0.5	3	Small Shrub																							
Machaera arthrophylla	1	3	Sedge																							
Meliccytus ramiflorus	2	3	Medium Tree				X																			
Myrsine australis	2	3	Medium Tree				X																			
Paesia scaberula	0.5	RT	Fern																							
Phormium cookianum	1	3	Medium Flax																							
Phormium 'Green Dwarf'	1	3	Low Flax																							
Phormium tenax	1	3	Medium Flax					0.15m																		
Pittosporum crassifolium	2	3	Small Tree				X																			
Pittosporum eugenioides	2	3	Small Tree				X																			
Pittosporum tenuifolium	2	3	Small Tree				X																			
Pittosporum tenuifolium 'Mountain Green'	2	3	Small Tree				X																			
Plagianthus regius	2.5	1.5m High	Medium Tree				X																			
Podocarpus totara	2.5	1.5m High	Tall Tree				X																			
Potamogeton cheesemanii	1	RT	Herb																							
Pseudopanax ferox	2	5	Small Tree				X																			
Schefflera digitata	2	5	Small Tree				X																			
Schoenoplectus validus	1	RT	Rush																							
Sophora 'Dragons Gold'	2	5	Small Shrub																							
Sophora microphylla	2	1.5m High	Small Tree				X																			
Streblus heterophyllus	2	3	Small Tree				X																			
Syzygium maire	2.5	1.5m High	Tall Tree				X																			
Typha orientalis	1	RT	Rush																							
Grassing			Groundcover																							
Roll-on Turfing			Groundcover																							

KEY:

- These species may be planted according to PSD requirements and species tolerances. Only those nominated cultivars are acceptable unless approved otherwise by Council.
- X Plant must not be planted in the Shallow Marsh Zone as they may damage the slope toe should they fall over and/or require future removal.
- > Indicates that the vegetation mix for this planting zone should have a high percentage of this plant.
- # Swales: Plant only on slopes. Forms trunks that impede water flow.
- * Plant species is not indigenous to the Waikato region, but is an approved PSD plant.
- ** Minimum staggered centres unless otherwise specified. Tree centres indicated are the minimum distances from other tree species and are to be underplanted with 4 equidistant same species groundcovers at 0.75m centres from tree trunk/stem.

NOTES:

- Plants should be 100% native.
- Planting plans need to be accepted by Council, and site specific plants can be put forward for consideration.
- The above list is a guide only and targets the early years of a planted device, for example, light and frost tender species could be introduced after the device is mature.
- Site specific constraints should always be taken into account, for example, the use of the land adjoining the riparian zone may limit the height of trees in this zone.

Swale Planting

Swales may be turfed or grassed to ensure rapid establishment and mitigate channel surface scouring. Generally, grass needs to be maintained at heights between 50mm and 150mm, depending on engineering design parameters.

Where engineering requirements permit, specific grass species may be planted in the Submerged and Shallow Marsh Zones. No other groundcover, shrub or tree species are permitted in these Zones. These need to be planted with mulch rounds.

Table 4-36: Swale Planting - Velocity/Grade Matrix

TYPE	GRADE	VELOCITY
Swale – Roll on Turfing	Less than 2%	Less than 1.5m/s at 10 year ARI flow
Swale – Vegetated	2-5%	Less than 2.5m/s at 10 Year ARI flow
Swale – Rocks	Greater than 5%	2.5m/s or greater at 10 Year ARI flow

Both during and post-establishment, the height of the turf shall be consistently maintained at least fortnightly to designed stormwater engineering requirements. Turf shall be of a drought-resistant hard-wearing rye-grass based variety with no weeds species.

Filter Planting

Filters can be planted with a mix of Council approved groundcovers, shrubs and trees according to the Planting Zone criteria, as site conditions and engineering requirements permit.

4.3 CONSTRUCTION AND MAINTENANCE

4.3.1 Pipeline Construction

This section covers the installation requirements for all piped stormwater systems. The installation of pipelines shall be carried out in accordance with the AS/NZS standard relevant to the material type.

4.3.2 Materials

Refer [Acceptable Products Section 8](#).

4.4 TOLERANCES

Pipes shall be accurately laid to the lines, levels and gradients shown on the Drawings using pipe-laying laser equipment.

Where the variation exceeds the tolerance Council may order the removal and relaying of any affected pipes.

4.4.1.1 **Invert Levels**

The permissible deviation from the designated level of the invert at each manhole or structure shall be $\pm 50\text{mm}$, provided that the fall between successive manholes or structures shall be at least 90% of that specified.

4.4.1.2 **Horizontal Alignment**

The permissible deviation of the horizontal alignment between manholes or structures shall be $\pm 100\text{mm}$.

4.4.1.3 **Gradient**

For straight gradients, the permissible deviation from the specified gradient shall be $\pm 50\text{mm}$ from a straight line drawn between the inverts of successive manholes, provided that no point in the pipeline is lower than any downstream point.

4.4.2 **Trenchless Construction**

4.4.2.1 **General**

Trenchless technology may be preferable or required as appropriate for alignments passing through or under

- a) Environmentally sensitive areas
- b) Built-up or congested areas to minimise disruption and reinstatement
- c) Railway and major road crossings
- d) Significant vegetation
- e) Vehicle crossings

Trenchless construction shall only be used for applications in which the specified tolerance can be achieved.

Pipes used for trenchless installation shall have suitable mechanically restrained joints, specifically designed for trenchless application, which may include integral restraint, seal systems, or heat fusion welded joints.

Any trenchless technology and installation methodology shall be chosen to be compatible with achieving the required gravity pipe gradient — refer to manufacturer's and installer's recommendations.

4.4.2.2 **Installation Methods**

Trenchless installation methods for new pipes include

- a) Horizontal directional drilling (HDD) (PVC with restraint joint/fusion welded PE)
- b) Uncased auger boring/pilot bore micro-tunnelling/guided boring (PVC with restraint joint/fusion welded PE)
- c) Pipe jacking (GRP/ reinforced concrete)

4.4.3 Joints

4.4.3.1 General

Specification of joints shall be as follows.

- a) All pipes shall have flexible joints of an approved type, such as RRJ
- b) Steel pipes shall be flexibly jointed (gibault 'denso' wrapped and sealed with approved outer wrapping or approved rubber ring)
- c) Joints shall be provided adjacent to manholes to the requirements of AS/NZS 2566 with the exception of PVC where proprietary connections may be used

4.4.3.2 Rubber Ring Joints

Rubber ring joints shall be installed strictly in accordance with the manufacturer's instruction. Care should be taken to ensure that the rubber rings are located evenly around the joint with no twists in them. The pipe shall be pushed up firm and tight to the joints.

4.4.3.3 Site Mortar Jointing of Pipes into Manholes

All mortar used for the 'on-site' jointing of drainage components shall be Expocrete 'UA' or an approved equivalent. The surface priming, mixing of components, application and cure period are to be in accordance with the manufacturer's directions.

4.4.4 Manholes

4.4.4.1 Channels and Benching

A semi-circular channel shall be formed in the concrete floor of the manhole. The benching shall rise vertically from the horizontal diameter of the pipe to the height of the soffit and then be sloped back at a gradient specified in Drawings [D4.21](#) – D4.23.

The flow channel shall be formed so that it presents an evenly curved flow path through the manhole. The cross section of the flow channel shall be uniform with the main channel benched.

Benching shall be floated to a dense, smooth hard surface using 3:1 sand cement mortar and a steel float. Side branches shall be similarly formed with a smooth bend into the main channel.

The benching shall have step recesses as shown on [Drawing D4.22](#). A U3 standard of finish as specified in NZS 3114 shall be achieved.

4.4.4.2 Flexible Joints

All pipe lines shall have a flexible joint adjacent to the manhole on all incoming and outgoing pipes. The base of the manhole shall extend up to these flexible joints. The upper part of the pipe inside the manhole shall be cut back to the wall, the reinforcement cut out and the ends plastered with epoxy to prevent rusting.

4.4.4.3 Manhole Steps

Bolt through Type Manhole Steps

The steps shall be bolted through the walls using properly formed and recessed bolt holes and be in accordance with [Section 8 Acceptable Products](#).

Prior to tightening, BM100 shall be placed around the shank both inside and outside the manhole riser. After the steps have been tightened in place the outside recess which houses the nut shall be sealed with Expocrete 'UA' or acceptable equivalent in accordance with the manufacturer's directions. Plastering of the recess will not be accepted. The sealant is to be applied at least 48 hours before the manhole risers are required for construction.

4.4.4.4 Concrete

All concrete shall have a minimum crushing strength of 20.0 MPa at 28 days, unless otherwise specified or detailed by Council.

4.4.5 Connections

All connections shall be sealed by removable caps until such time as they are required.

All connections and disconnections to or from Council pipes and all works outside the property boundary shall be undertaken by Council or an approved contractor.

Connections shall be constructed as per [Drawing D4.24](#).

4.4.6 Catchpits

The connection of the lead into the catchpit shall be constructed as detailed in Drawings [D4.6](#) – D4.10.

4.4.7 Backfilling and Reinstatement

Backfilling shall keep pace with the excavation and laying of pipes so that not more than 15m of pipes shall be left exposed in open trench to prevent flotation.

4.4.8 Embedment

The designed trench width shall be the minimum width to allow pipes to be safely laid and all embedment material properly and sufficiently compacted.

The foundation shall be able to support all design loads placed on it for the duration of the lifecycle of the pipeline it supports. Where the bottom of the trench will not provide adequate support for the pipe the designer shall be contacted to provide a suitable means to stabilise trench foundation. Acceptable methods include:

- Groundwater drainage
- Use of geotextile fabric
- Cement stabilisation or
- Removal of unsuitable material and replacement with compacted selected material

No embedment material shall be placed or pipes laid before the trench foundation has been inspected and accepted by a suitably qualified drainlayer or engineer.

Where pipelines have protrusions such as sockets, flanges or couplings, a suitable recess shall be provided in the supporting material to ensure the pipeline is fully supported along the pipe barrel.

Any PVC pipes shall be laid with product labelling uppermost in the trench.

4.4.9 Fill

4.4.9.1 General

The trench or embankment fill material, shall be as specified. Where reuse of previously excavated material is proposed its use shall be approved by the designer. The density of the fill material shall not be less than that of the original material prior to excavation. When compacting in layers the depth of each layer shall be as specified by the designer.

The depth of fill must comply with the relevant pipe AS/NZS standard.

Mechanical compaction of the fill material directly above the pipe shall not be used until the depth of cover above the top of the pipe is adequate to prevent damage. Non-mechanical compaction equipment may be required.

4.4.9.2 Fill outside a Transportation Corridor and other Trafficked areas

Trench or embankment fill shall be compacted in layers to the specified finished level. The designer shall specify a testing regime to verify the compaction effort meets the density specified.

4.4.9.3 Fill in a Transportation Corridor and other Trafficked areas

Trench or embankment reinstatement shall conform to the requirements shown on Transportation Section [Drawing D3.2.3](#) 'Trench Reinstatement'. Trench or embankment fill shall be compacted in layers to the specified finished level. The designer shall specify a testing regime to verify the compaction effort meets the density specified to support the designed traffic loading.

4.4.9.4 Outside of Transportation Corridor

Bulk backfill shall be placed in layers and mechanically compacted. The degree of compaction shall be such as to produce an in-situ density which shall not be less than that of the original material prior to excavation. To establish the criteria for compliance, Scala Penetrometer tests shall be carried out along the line of the trench prior to excavation.

There shall be not less than one test per 50m of trench length. Compaction tests (or substituted Scala Penetrometer tests) shall be carried out for the full depth of the trench to within 300mm of the pipeline (subsequently referred to as the 'test area'). There shall be at least one test area per 50m of trench length, or, at least one test area per 50m³ of trench backfill, whichever method returns the greater number of test areas.

Compaction test results (or substituted Scala Penetrometer tests) shall be submitted to Council for acceptance.

The area shall be reinstated to the same condition or better.

All drains, fences and other structures shall be replaced or reconstructed to their pre-construction, or better, standard and in their original place.

4.4.9.5 In Transportation Corridor

Pipe trenches shall be backfilled using an approved hardfill placed immediately above the pipe embedment and reinstated as specified by [Drawing D3.2.3](#). The depth of the basecourse and type of finishing seal coat shall conform to the standard of the existing road construction.

Compaction test results (or substituted Scala Penetrometer tests) shall be submitted to Council for acceptance.

4.4.10 Stormwater Treatment and Detention Devices

4.4.10.1 Planting

Stormwater treatment and detention devices are to be planted up as soon as possible after civil construction is completed according to the Planting Zones indicated in Table 4-34. All stormwater features with an inner batter slope ratio of 1 (vertical) to 4 (horizontal) or steeper must be landscaped (planted) as the slope is too great for safe maintenance.

Where site conditions such as unstable soil structures require a more rapid groundcover than shrubs and trees provide, exposed surfaces above the Riparian and Littoral Edge Planting Zones shall be stabilised with grassing prior to landscape planting.

Planting within the Shallow Marsh Zone shall be installed at the same time that the upper slopes receive grassing to minimise slope toe erosion. The Submerged Zone shall be planted up once the normal standing water level has been achieved and it must then be maintained.

Where feasible, consider placing rough logs, dead trees (snags), large rocks/boulders in select locations to encourage wildlife habitats. Ensure that the slope stability, slope toe, inlet, outlet, water flow and forebay are not compromised by the placement of these items and that maintenance can be carried out. Ensure no soil compaction occurs during the installation in surrounding area. The Developer shall consult with an Ecologist and Council prior to material selection and placement.

Minimum planting provision requirements are:

- a) Quick establishment of plant cover is required throughout the site, as engineering requirements permit
- b) No material storage or heavy equipment is to be stored within the site or buffer area after site clearing except to excavate and/or grade site
- c) All construction and other debris are to be removed prior to topsoil placement
- d) Soil testing and making adjustments is required (refer to Landscape Section)
- e) Unless existing soil is unstable, sloped soils shall be ripped 150mm deep either in a criss-cross pattern or horizontal to base (following contours) prior to topsoil application. Heavy clay will need deeper ripping. Topsoil shall be spread to a minimum 200mm depth, ensuring heavy equipment does not compact the slopes
- f) Where bark mulch is used, it is to be contained within the plant area that it is providing cover for. Other mulch applications are to be utilised on slopes greater than 1:3

4.4.10.2 Staged Planting

The staged planting shall be as follows.

Stage 1: Grassing

Banks shall be prepared and sown with grass seed to establish rapid ground stabilisation, according to the [Landscape Section](#) Clauses 7.3.6.

Where plants are to be established in nitrogen-deficient soils, the seed mixture shall be:

- Annual Rye Grass 150 kg/ha
- Sweet Clover 100 kg/ha

All seed shall be certified and less than 12 months old at the time of sowing. The Ryegrass component is to be certified as having greater than 80% live endophyte content. Council may prohibit the use of seed that has deteriorated because of wetting, fertiliser burning, etc. Otherwise the standard landscaping grass seed specifications shall apply as per the Landscape Section 7.3.6.

The site shall be grassed for at least three months and meet establishment requirements for sown areas prior to landscaping. Shallow Marsh Zone planting and mulching shall be established at Stage 1.

Stage 2: Landscape Planting

Stage 2 planting shall occur within the Council planting season (May to August inclusive) once Stage 1 sown grass has established. Ensure that no weed species exist throughout the site. Where weed species need to be eradicated either carefully spot spray and/or hand-pull in such a manner that erosion is minimised and surrounding groundcover remains undamaged. The sown grass groundcover shall be spot sprayed to 0.50m diameter for each location where individual plants are to be planted four weeks prior to planting, ensuring that the established grass between spot sprays remains undamaged. Maintain sprayed areas so that no new weed growth exists at time of planting. Install and establish planting and mulching as per the Landscaping Section.

4.4.10.3 Plant Spacing

Plants are to be planted according to the following spacing allocations.

- a) Within the Shallow Marsh Zone, Carex shall be evenly staggered at 1.0m intervals
- b) Where plantings are to include approved partially submerged species, these are to be irregularly clumped in groups of 3 to 7 plants along the circumference of the stormwater wetland/pond
- c) For permanent stormwater ponds, plant 0.4m below the designed normal standing waterline, approved sedges and rushes
- d) Amenity plantings of tussocks are to be clumped in groups of 3 to 10 plants
- e) Trees shall be spaced at minimum 2.5m centres from other trees and underplanted with 4 equidistant same-species groundcovers, installed 0.75m

from the tree stem. The groundcover species shall provide a weed suppression canopy while the tree is establishing, and as such will have no more than 1.0m mature height and minimum 0.75m spread. Ensure that the groundcover species does not compete with the tree establishment requirements. Depending on the Zone planting location, possible plants could be *Phormium* 'Green Dwarf', various *Carex* such as *Carex virgata*, and *Coprosma* groundcovers such as *Coprosma kirkii* 'Minogue'

- f) In respect to the maintenance access track
- (i) No shrub or groundcover centres are to be located within 1.0m of the track
 - (ii) No trees centres are to be located within 2.5m of the track
 - (iii) Plantings within 2.0m either side of the access track are to have species that are able to recover quickly should they become damaged during pond maintenance
 - (iv) In subdivision and shopping complexes, planting design either side of the access track should also ensure that the track may be used for pedestrian amenity purposes

4.4.10.4 Staking and Protection

Trees 1.5m High or Greater

Newly planted trees shall be staked with 2no. 50mm x 50mm x 1.8m rough sawn Pine H5 treated stakes with at least one third of their length (600mm) in the ground and at least 1.0m exposed minimum, or as specified on the plan with the approval of Council. All stakes shall be inserted to avoid hitting the root ball. Stakes shall be at least 400mm away from the tree trunk and no more than 500mm away.

Two flexible ties per stake shall be attached. Ties shall be tensioned to avoid chafing of the tree against the stakes but with enough play for the tree to move in the wind. All ties shall be fixed to the stakes. Ties shall be of a type approved by Council prior to tying. Ties are to be fixed to the outer stake face with a minimum of four staples in a square pattern.

Smaller Grade Staking

- All tree species planted at 2 litre to 12 litre grades
- All shrub species planted at greater than 5 litre grades

Shall be staked with a single 1.2m minimum long 22mm - 25mm diameter dead bamboo stake, positioned outside the root ball, driven into the ground to at least a 400mm depth. The stake is to be fastened two thirds up the plant stem/trunk with a Council approved interlocking tree tie (e.g. Treelock). If the tree tie is not biodegradable:

- The tie shall be adjusted periodically so that the stem/trunk does not become damaged or the stem/trunk grows over the tie.
- The tie shall be removed at a time designated during the design phase of the landscape planting.

Some nursery-supplied plants are provided with a stake attached, usually directly against the main stem. This stake is to be removed and replaced according to this specification.

4.4.10.5 Site Preparation

In regard to adjacent water bodies and/or courses, ensure that no debris or chemical spray enters or impedes the functionality of the water body, whether it is natural or manmade.

4.4.10.6 Mulching

All areas shall be mulched except for areas that are grassed or turfed. All mulch is to be approved by the Council prior to spreading.

The types of mulching specified are to ensure rapid planting establishment while maintaining good ground infiltration without souring the soil or causing negative amenity values, and allowing some scope for landscape design variations. Mulching shall be as detailed in Table 4-37.

Council favours biodegradable weed mats over synthetic geotextile weed matting. No synthetic geotextile weed matting or weed matting with synthetic geonet content is to be utilised in the installation of the landscaping portion of landscaping engineered stormwater devices. However, synthetic geotextiles and other materials may be used, as applicable, to meet device engineering requirements; for example, at inlets, outlets and high velocity channels. Biodegradable matting must:

- a) Be a single layer of biodegradable mulching fabric or material without synthetic geonet or geotextile content with at least 1000 g/m² density composed of approximately 100-125mm long coir fibres, and preferably a 100% rubber-based binder
- b) Have a minimum of 24 months life expectancy and be fully biodegradable into soil within six years
- c) Prevent weed growth within the mulched area
- d) Help stabilise the soil while plants are establishing
- e) Not easily lift from the ground if submerged for periods of time
- f) Appear tidy from a visual amenity perspective

A simple test to ascertain whether the mulching fabric is viable is to hold a sample to the sky. It should be mostly opaque. This density inhibits weed seeds trapped under the mulching fabric from sprouting, provides good moisture retention and assists with batter erosion control.

At Council's discretion, mat rounds may be used instead of matting. These shall be a minimum 500mm diameter and have the same characteristics as the mulch fabric. Each round shall be secured to the ground with eight pins: four pins equidistant near the outer edge and four pins around the plant stem. Pins shall be a minimum 300mm long to prevent Pukeko removal.

Landscape Section technical specifications apply where bark mulch is used. Ensure it is contained within the plant area that it is providing cover for. Likewise bark mulch is not permitted:

- a) Within 3.0m of any watercourse or water body
- b) Where water ponding or flooding may occur
- c) On slope gradients of greater than a 1:3 ratio

Biodegradable coir netting and staked coir logs may be used in high erosion sites as the Landscaping Section.

4.4.10.7 Amenity Areas Mulching

Landscape planting between the drainage reserve boundaries to the Riparian Zone shall only be mulched with bark or aged woodchip mulch where there is no possibility of surface ponding, flooding or mulch travel. Where surface ponding, flooding and mulch travel is possible within this area, biodegradable weed matting shall be used for all landscape planting.

Table 4-37: Approved Mulching

DEVICE	PLANTING ZONE	MULCH TYPE
Rain garden	All	Council accepted biodegradable weed matting
Wetland	Amenity Planting – Site Entrance and Drainage Reserve Boundary Line to Riparian Zone where no ponding, flooding or mulch travel is possible	Council accepted bark and/or aged woodchip
	Amenity Planting – Site Entrance and Drainage Reserve Boundary Line to Riparian Zone where ponding or flooding is possible	Council accepted biodegradable weed matting
	Riparian and Littoral Edge Zones	Council accepted 0.5m diameter biodegradable weed matting rounds
	Shallow Marsh Zone	Council accepted biodegradable weed matting
	Submerged Zone	No mulch required
Swale – River Rocks	All	Loose 50mm - 150mm diameter river rocks on biodegradable weed mat
		River rocks of 50mm - 150mm diameter encased in gabion matting
Swale – Roll-on Turfing	All	No mulch
Swale – Vegetated (Carex grasses)	All	Council approved biodegradable weed mat or secure biodegradable mat rounds
Grass Filters Strips	All	No mulch

4.4.10.8 Riparian and Littoral Edge Zone Mulching

All plants shall be mulched with Council approved 0.5m diameter biodegradable weed mat rounds that shall be secured around plants, allowing adequate room around the stem for future growth. Firmly secure fabric mulch with wooden or other biodegradable pegs as per the manufacturer’s instructions so that the fabric mulch does not detach from the soil, during inundation and high winds.

4.4.10.9 Shallow Marsh Zone Mulching

Council approved biodegradable weed mat is to be laid in a manner that the mulch will not uplift during inundation. Ensure that plants have adequate room around the stems for future growth.

4.4.10.10 Submerged Zone Mulching

No mulching is required within the Submerged Zone.

4.4.10.11 Stormwater Information Board

A stormwater information board is to be installed adjacent to the stormwater devices. Developers are to confirm wording for the information board specific to their device with Council. An example information board is to be added a later date as [Drawing D4.27](#).

4.5 AS-BUILT INFORMATION

Upon completion of construction work, copies of As-built plans and data attributes of the completed works, as described in Clause 1.9 of [Section 1 : General](#), shall be provided to the Council. Separate plans are required for wastewater, stormwater, and water supply.

Responsibility for providing the plans and associated data shall lie with:

- a) The Developer, in the case of land development (urban and industrial subdivision).
- b) The Contractor, in the case of works constructed for Council under contract to Council.

4.6 DEFECTS LIABILITY

4.6.1 Defects Liability Periods

The following Defects Liability Periods apply to all planted treatment and detention devices, after obtaining Council's acceptance as per **Error! Reference source not found.**

Table 4-38: Defects and Liability Periods

TYPE	DEFECTS LIABILITY PERIOD
Dry detention basins	Where dry detention basins are to be permanently grassed, the Defects Liability Period for the grassing is a minimum of six months if sown between May and August. If sown between September and April the period is extended for a further six months.
Wetlands, Rain Gardens, Swales and Filters (including staged planting)	<p>Stage 1: Temporary Grassing (if applicable) The Stage 1 Grassing Defects Liability Period will extend for a minimum of six months or until such time as Stage 2 Planting is investigated</p> <hr/> <p>Stage 2: Landscape Planting The Stormwater Stage 2 Defects Liability Period shall be a minimum of 24 months except when planting is carried out between September and May the Defects Liability Period shall be extended for an additional six months.</p>

4.6.2 Defects Maintenance Requirements

The Developer/Contractor shall be responsible for the routine maintenance of the landscape planting works including weeding, mulching, replacement of plants and watering during the defects liability period.

The minimum standards required during the Defects Liability Period shall be as per Table 4-39.

At the end of the required defects liability period, the Developer/Contractor shall advise the Council at least 7 working days prior to vesting the asset, or Practical Completion has been achieved.

Table 4-39 : Defects Period Maintenance Schedule

MAINTENANCE TYPE	SUB-TYPE REGIME	FREQUENCY (MONTHS)
Mulching bark	Check and ensure that mulch has not deteriorated nor travelled below the Riparian Zone	12
	Replace where quality and depth has diminished below specification requirements. Bark should only be topped up during winter or spring	
Biodegradable matting	Check, repair or replace any matting that has rips and non-plant stem holes. Matting should remain intact for minimum 24 months post-planting installation	6
Biodegradable rounds	Check and ensure rounds are intact and remain properly pegged around plant stems for minimum 24 months post-planting installation. Remove any weeds that have uplifted rounds	3
Permanent grass	Check and ensure that permanent grass is establishing and maintained to a minimum 100mm height and maximum 200mm height in accordance with the Landscaping Section	3
Planting establishment	Check and ensure all installed plants are healthy and free of pests, disease, spray and weed-trimmer damage, and are growing generally consistent with the species type shape and form	3
	Where plants are not establishing, either remediate or replace plants	
Installed trees	Check and ensure that trees remain staked as per specifications	3
	Check and ensure that all trees are growing upright	
Self-seeded trees	Remove all self-seeded trees from the Submerged Zone and Shallow Marsh Zone without damaging embankment toe and installed plants. Use systemic pre-mix picloram gel where this is not feasible	3
Replacements	Keep a record of all replacement plants installed, including the plant species botanical name, plant grade, quantity and date(s) planted	As required
	Replacement installations should only occur between 1 April to 1 October each year in the Shallow Marsh, Littoral	

MAINTENANCE TYPE	SUB-TYPE REGIME	FREQUENCY (MONTHS)
	Edge and Riparian Zones. Planting in the Submerged Zone may occur in any season as long as the soil is moist to a depth of 300mm at the location of planting	
Rubbish	Check and remove any domestic rubbish or building material within the site	3
Soil moisture	Check and ensure that all areas with installed planting have soil that is moist to a 200mm depth. Irrigation may be required during summer if planting installation was late spring-early summer	3
Stormwater inlets and outlets plant cover	Ensure that no plants are evident within 1.0m of the stormwater inlet and outlet pipes	3
Swale maintenance channel	Check and remove weeds, dead plants, debris dams and pest damage	6
	Remediate any channel surface scouring that has occurred	
	Ensure that Submerged Zone plants are no higher than 0.5m high	
	Remove any non-installed plants from the swale channel	
Vegetative waste	Ensure that all vegetative waste is safely removed and disposed of offsite	3
	Check and remove any vegetative debris that is blocking the access track	
Weeds noxious plants	Check, remove and dispose of safely all noxious plants, including root systems	3
Notifiable plants	Notify Waikato Regional Council should any notifiable weeds be identified	3
Weed cover	Check and ensure that there is no more than one 300mm high weed per 1.0m ²	
Weed control	Check and ensure that all plants are fully weed-released	3
	Weeds may be controlled by weed-trimming, chemical or steam spraying, hand or other manual releasing unless otherwise specified	
Chemical spraying	Ensure that no chemical spraying occurs in the Submerged Zone and Shallow Marsh Zone. All weeds growing in these Zones must be removed by other means	As required

4.6.2.1 Spraying and Weed Control

Chemical weed control shall be carried out in accordance with [Landscape Section](#), Clause 7.3.10 ensuring that no spray enters any water body or watercourse.

In respect to wetland, where weed species exist both on and within 2.5m adjacent to the normal standard waterline, weeds shall be controlled by either hand-pulling or weed-eating in such a manner that no debris enters any water body or watercourse.

Unwanted woody vegetation, such as Salix caprea (Pussy Willow), must not to be removed with hand-pulling or weed-eating. Use a systemic pre-mixed gel containing picloram according to manufacturer’s instructions.

4.6.3 Final Defects Inspection Criteria

To achieve final Defects Liability approval, the stormwater treatment and detention device shall meet the following ‘planting’ criteria as outlined in the following tables where applicable.

Percentages indicated are based on the total quantity of plants specified on the accepted Planting Plan Plant Schedule.

Note: Any defects liability period extensions shall apply to the whole of the site.

Table 4-40: Planting Establishment

ZONE	PLANTING ESTABLISHMENT REQUIREMENTS
Submerged Zone	75% planting established 25% establishing.
Shallow Marsh Zone	100% plants established
Littoral Edge Zone	Groundcovers: <ul style="list-style-type: none"> • 75% established • 25% establishing Shrubs: <ul style="list-style-type: none"> • 50% established • 50% establishing All trees establishing
Riparian Zone	Groundcovers: <ul style="list-style-type: none"> • 75% established • 25% establishing Shrubs: <ul style="list-style-type: none"> • 50% established • 50% establishing All trees establishing
Plant Canopy	Littoral Edge and Riparian Zone groundcover canopy is providing 50% minimum cover over ground surface
Planting Density	Installed plantings are at the approved consent planting plan centres

Table 4-41: Minimum Inspection Requirements

INSPECTION	MINIMUM REQUIREMENTS
Loose Mulch (for example, bark)	<ul style="list-style-type: none"> 75 mm minimum depth between plants and 25 mm maximum depth around plant stems No loose mulch is below the bottom edge of the Riparian Zone
Permanent Grass	<ul style="list-style-type: none"> Permanent grass has established and is maintained in accordance with the Landscape Section
Planted Areas Soil	<ul style="list-style-type: none"> All planted areas shall be moist to at least 200mm
Replacements	<ul style="list-style-type: none"> All replacement plants that have been installed due to plant failure have been successfully establishing on site for at least three months. Council may request replacement records to verify installation dates No more than 25% replacements have been installed three months prior to the final defects inspection More than 25% replacements shall incur a 12 month minimum defects extension Should the final defects inspection find that areas of the device require replacement planting: <ul style="list-style-type: none"> Less than 25% replacements shall incur an additional three months defects period after replacement planting has been completed to Council's approval, if the replacement planting occurs between May and August, otherwise the extended defects shall be six months minimum. More than 25% replacements shall incur an additional 12 months defects period after replacement planting has been completed to Council's approval.
Rubbish	<ul style="list-style-type: none"> No rubbish, including domestic and building material is evident within the Drainage Reserve, or where the device is located elsewhere, within 5m of the device
Spraying	<ul style="list-style-type: none"> There is no evidence of installed plants killed or severely damaged by weed spraying.
Stormwater Inlets and Outlets	<ul style="list-style-type: none"> No plants are evident within 1.0m of the inlet and outlet pipes.
Trees	<ul style="list-style-type: none"> Where trees were installed with stakes, the trees are staked and tied as per this specification. Trees are upright, healthy, free of disease and pests, without spray or weed-trimmer damage, and of good conformation No self-seeded trees are growing within the Submerged or Shallow Marsh Zones
Weed Cover	<ul style="list-style-type: none"> The device has no noxious or Waikato Regional Council notifiable plants evident There is no more than one 300mm maximum height weed per 1 m² within the device All plants are fully weed released There is no evidence of vegetative waste within the Drainage Reserve, or where the device is located elsewhere, within 10m of the device.
Weed Matting	<ul style="list-style-type: none"> Within 24 months of planting installation, biodegradable matting remains intact, has no non-plant stem holes or rips, and has not become brittle enough for a hole to be created if stood on by an adult wearing safety boots Where matting rounds have been used: <ul style="list-style-type: none"> These are intact Are properly pegged to the ground around plants as per manufacturer's

INSPECTION	MINIMUM REQUIREMENTS
	instructions; and ○ Have no weeds uplifting them from underneath the round.

4.7 ACCEPTANCE OF PROPOSED WORKS

4.7.1 Stormwater Treatment and Detention Devices

The acceptance process for stormwater pipe system, treatment and detention devices is as follows.

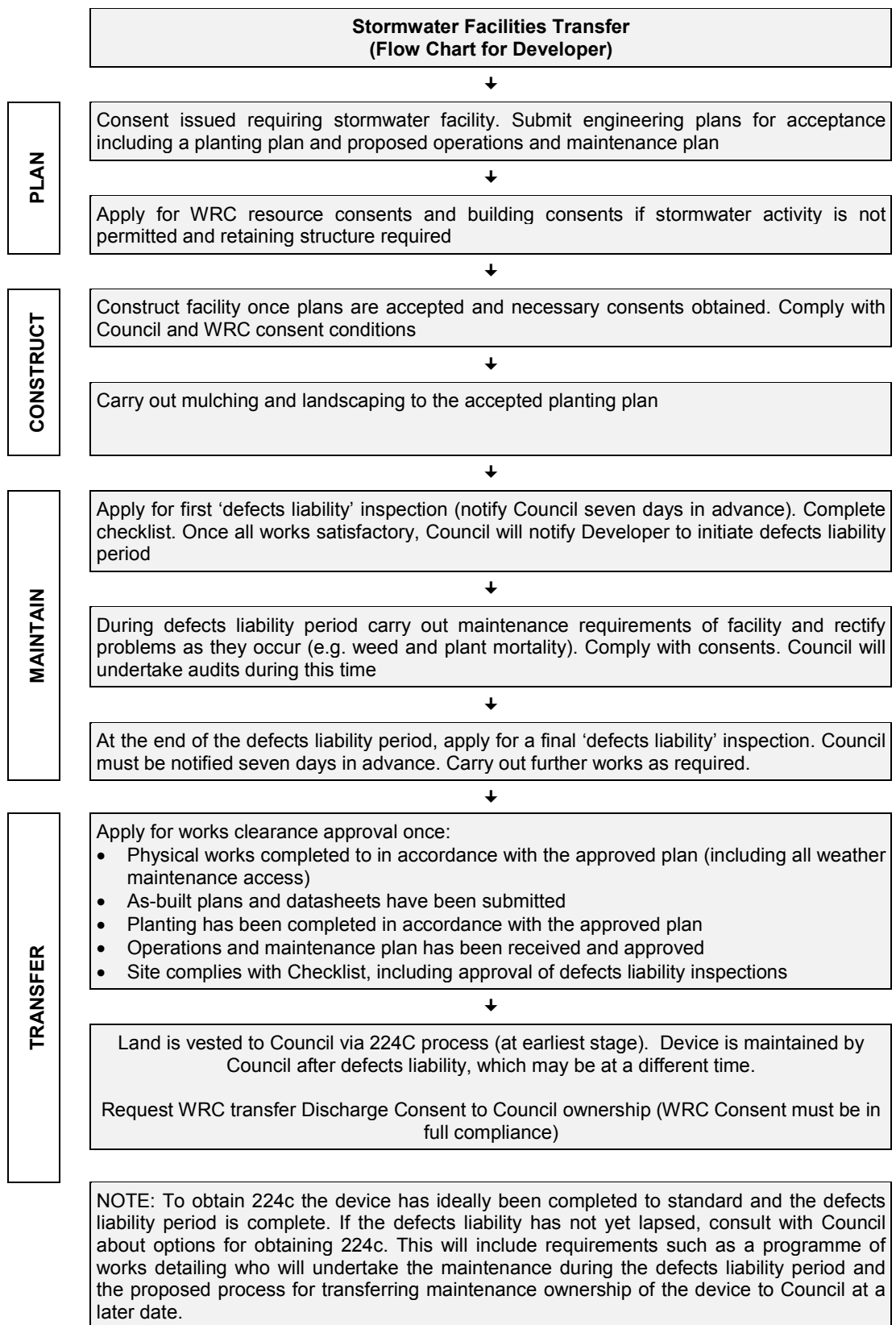

Drawing 4-9: Stormwater Devices Transfer Process

FORMS AND CHECKLISTS

Table 4-42: Forms and Checklists

NO.	TITLE
F4.1	Stormwater Design Confirmation
F4.2	Stormwater Pipe Laying Checklist
F4.3	Stormwater Manhole Checklist
F4.4	Stormwater Trench Backfill Compaction Test Summary
F4.5	Stormwater Catchpit Checklist
F4.6	Stormwater Pipe Network Final Inspection Checklist
F4.7	Wetland Construction Inspection Checklist
F4.8	Wetland and Inspection / Signoff Checklist

F4.1 STORMWATER – DESIGN CONFIRMATION

Site Address	Project Name	
Consent Number	SUB _____ / _____	LUC _____
Name of Developer		
Name of Designer	Name of Consultant:	
Designer's relevant qualifications		
Plan Numbers:	Revision:	
Calculation Sheets attached: (list)		
I hereby confirm that the design of the stormwater provision for the above site has been designed in accordance with the RITS and the Conditions of Consent.		
Signed: _____		Date: _____
Designer		

Engineering Exception Decisions		
The following aspects of the design do not meet the requirements of the RITS. Note 1 : Where standards are not met, please detail the alternative standard achieved. Note 2 : The non-complying aspects will require acceptance by the Council's Asset Manager.	Accepted?	
	Y	N
Exception Item	Explanation of Alternative Standard	

Engineering Exception Decision accepted by _____
Asset Manager

Date

F4.2 STORMWATER PIPE LAYING CHECKLIST

Engineering plan number(s):					
Name of certified drainlayer:					
Location: Pipe length (MH To MH)	to	to	to	to	to

Pipe Laying Checks

Trench Safety	<input type="checkbox"/>	<input type="checkbox"/>	<input type="checkbox"/>	<input type="checkbox"/>	<input type="checkbox"/>
(a) Shield	<input type="checkbox"/>	<input type="checkbox"/>	<input type="checkbox"/>	<input type="checkbox"/>	<input type="checkbox"/>
(b) Batter	<input type="checkbox"/>	<input type="checkbox"/>	<input type="checkbox"/>	<input type="checkbox"/>	<input type="checkbox"/>
(c) Other	<input type="checkbox"/>	<input type="checkbox"/>	<input type="checkbox"/>	<input type="checkbox"/>	<input type="checkbox"/>
Pipe size, quality, manufacturer, on acceptable products list	<input type="checkbox"/>	<input type="checkbox"/>	<input type="checkbox"/>	<input type="checkbox"/>	<input type="checkbox"/>
Set out	<input type="checkbox"/>	<input type="checkbox"/>	<input type="checkbox"/>	<input type="checkbox"/>	<input type="checkbox"/>
– Surveyors name _____	<input type="checkbox"/>	<input type="checkbox"/>	<input type="checkbox"/>	<input type="checkbox"/>	<input type="checkbox"/>
– Set out checked	<input type="checkbox"/>	<input type="checkbox"/>	<input type="checkbox"/>	<input type="checkbox"/>	<input type="checkbox"/>
Foundation support attached	<input type="checkbox"/>	<input type="checkbox"/>	<input type="checkbox"/>	<input type="checkbox"/>	<input type="checkbox"/>
– Dynamic cone penetrometer (DCP) results	<input type="checkbox"/>	<input type="checkbox"/>	<input type="checkbox"/>	<input type="checkbox"/>	<input type="checkbox"/>
– if under cutting required, note metreage and DCP results.	<input type="checkbox"/>	<input type="checkbox"/>	<input type="checkbox"/>	<input type="checkbox"/>	<input type="checkbox"/>
Record daily level check and confirm on grade	<input type="checkbox"/>	<input type="checkbox"/>	<input type="checkbox"/>	<input type="checkbox"/>	<input type="checkbox"/>
Bedding type and surround material:	<input type="checkbox"/>	<input type="checkbox"/>	<input type="checkbox"/>	<input type="checkbox"/>	<input type="checkbox"/>
Bulk Backfill material:	<input type="checkbox"/>	<input type="checkbox"/>	<input type="checkbox"/>	<input type="checkbox"/>	<input type="checkbox"/>
Bulk backfill compaction (DCP results from pipe to ground level attached)	<input type="checkbox"/>	<input type="checkbox"/>	<input type="checkbox"/>	<input type="checkbox"/>	<input type="checkbox"/>
Alignment – control points identified	<input type="checkbox"/>	<input type="checkbox"/>	<input type="checkbox"/>	<input type="checkbox"/>	<input type="checkbox"/>
Pressure test witnessed and passed by Council representative.	<input type="checkbox"/>	<input type="checkbox"/>	<input type="checkbox"/>	<input type="checkbox"/>	<input type="checkbox"/>

Service connections

All service connections in place, taped, and staked	<input type="checkbox"/>	<input type="checkbox"/>	<input type="checkbox"/>	<input type="checkbox"/>	<input type="checkbox"/>
As-built measurements taken, GPS located	<input type="checkbox"/>	<input type="checkbox"/>	<input type="checkbox"/>	<input type="checkbox"/>	<input type="checkbox"/>
CCTV pipe inspection data and comments supplied	<input type="checkbox"/>	<input type="checkbox"/>	<input type="checkbox"/>	<input type="checkbox"/>	<input type="checkbox"/>

Developer/Contractor

Date

F4.3 STORMWATER MANHOLE CHECKLIST

Engineering Plan Number(s)					
Name of certified drainlayer:					
Location: Pipe length (MH To MH)	to	to	to	to	to

	MH number				
Manhole Construction Checklist					
Manhole size, quality, manufacturer on acceptable materials list	<input type="checkbox"/>	<input type="checkbox"/>	<input type="checkbox"/>	<input type="checkbox"/>	<input type="checkbox"/>
Set out /orientation	<input type="checkbox"/>	<input type="checkbox"/>	<input type="checkbox"/>	<input type="checkbox"/>	<input type="checkbox"/>
Sealing strip between risers	<input type="checkbox"/>	<input type="checkbox"/>	<input type="checkbox"/>	<input type="checkbox"/>	<input type="checkbox"/>
Benching – Height – alignment and cross section – half pipe lining (wastewater only) – Step recesses (if applicable)	<input type="checkbox"/> <input type="checkbox"/> <input type="checkbox"/> <input type="checkbox"/> <input type="checkbox"/>	<input type="checkbox"/> <input type="checkbox"/> <input type="checkbox"/> <input type="checkbox"/> <input type="checkbox"/>	<input type="checkbox"/> <input type="checkbox"/> <input type="checkbox"/> <input type="checkbox"/> <input type="checkbox"/>	<input type="checkbox"/> <input type="checkbox"/> <input type="checkbox"/> <input type="checkbox"/> <input type="checkbox"/>	<input type="checkbox"/> <input type="checkbox"/> <input type="checkbox"/> <input type="checkbox"/> <input type="checkbox"/>
Flexible joints	<input type="checkbox"/>	<input type="checkbox"/>	<input type="checkbox"/>	<input type="checkbox"/>	<input type="checkbox"/>
Cutting and plastering of connections	<input type="checkbox"/>	<input type="checkbox"/>	<input type="checkbox"/>	<input type="checkbox"/>	<input type="checkbox"/>
Access details per drawings (e.g. manhole cover sited over steps).	<input type="checkbox"/>	<input type="checkbox"/>	<input type="checkbox"/>	<input type="checkbox"/>	<input type="checkbox"/>
Step irons including epoxy to outside recesses	<input type="checkbox"/>	<input type="checkbox"/>	<input type="checkbox"/>	<input type="checkbox"/>	<input type="checkbox"/>
Bedding type and surround	<input type="checkbox"/>	<input type="checkbox"/>	<input type="checkbox"/>	<input type="checkbox"/>	<input type="checkbox"/>
Bulk backfill compaction - Dynamic Cone Penetrometer (DCP) results attached	<input type="checkbox"/>	<input type="checkbox"/>	<input type="checkbox"/>	<input type="checkbox"/>	<input type="checkbox"/>
No debris in pipelines	<input type="checkbox"/>	<input type="checkbox"/>	<input type="checkbox"/>	<input type="checkbox"/>	<input type="checkbox"/>
Pipe invert fall through manhole	<input type="checkbox"/>	<input type="checkbox"/>	<input type="checkbox"/>	<input type="checkbox"/>	<input type="checkbox"/>

Developer/Contractor

Date

F4.4 STORMWATER TRENCH BACKFILL COMPACTION TEST SUMMARY

(attach individual test reports)

Technician _____ Carrying _____ out _____ Tests _____

Location:

Plan No(s):

From MH _____ to MH _____

Acceptance Criteria:

Tests by: _____ (attached)

Analysis of Results

Trench backfill completed satisfactorily or Trench backfill requires remedial work as follows:

Developer/Contractor

Date

F4.5 STORMWATER CATCHPIT CHECKLIST

Location:					
------------------	--	--	--	--	--

Catchpit Number

Catchpit Construction Checklist

Catchpit , type, size, quality, accepted material checked	<input type="checkbox"/>	<input type="checkbox"/>	<input type="checkbox"/>	<input type="checkbox"/>	<input type="checkbox"/>
Set out /orientation	<input type="checkbox"/>	<input type="checkbox"/>	<input type="checkbox"/>	<input type="checkbox"/>	<input type="checkbox"/>
Location checked	<input type="checkbox"/>	<input type="checkbox"/>	<input type="checkbox"/>	<input type="checkbox"/>	<input type="checkbox"/>
Depth of sump below outlet correct	<input type="checkbox"/>	<input type="checkbox"/>	<input type="checkbox"/>	<input type="checkbox"/>	<input type="checkbox"/>
Cutting and plastering of outlet connection	<input type="checkbox"/>	<input type="checkbox"/>	<input type="checkbox"/>	<input type="checkbox"/>	<input type="checkbox"/>
Floating debris baffle installed correctly	<input type="checkbox"/>	<input type="checkbox"/>	<input type="checkbox"/>	<input type="checkbox"/>	<input type="checkbox"/>
Backfill compaction around pit checked	<input type="checkbox"/>	<input type="checkbox"/>	<input type="checkbox"/>	<input type="checkbox"/>	<input type="checkbox"/>
Seating and plastering of surround and grate to sump barrel	<input type="checkbox"/>	<input type="checkbox"/>	<input type="checkbox"/>	<input type="checkbox"/>	<input type="checkbox"/>
All silt and debris removed from sump	<input type="checkbox"/>	<input type="checkbox"/>	<input type="checkbox"/>	<input type="checkbox"/>	<input type="checkbox"/>

Developer/Contractor

Date

F4.6 STORMWATER PIPE NETWORK - FINAL INSPECTION CHECKLIST

Site/Location:
Developer/Contractor:
SUB _____ / _____ Contract No:

PRE-MEETING TASKS

Developer to verify checklist prior to meeting:	Developer Check	Council Rep Check
1. All relevant stormwater checklists completed	<input type="checkbox"/>	<input type="checkbox"/>
2. All lines flushed out	<input type="checkbox"/>	<input type="checkbox"/>
3. All required CCTV inspections carried out, reviewed and any re-work completed.	<input type="checkbox"/>	<input type="checkbox"/>
4. All manholes checked (eg.infiltration, plastering)	<input type="checkbox"/>	<input type="checkbox"/>
5. All backfilling complete and tidied up	<input type="checkbox"/>	<input type="checkbox"/>
6. Final as-built and operational plans attached for site inspection	<input type="checkbox"/>	<input type="checkbox"/>

SITE MEETING

1. Inspect all lines	<input type="checkbox"/>	<input type="checkbox"/>
2. Inspect all manholes and catchpits	<input type="checkbox"/>	<input type="checkbox"/>
3. Works on third party land completed to satisfaction of owner	<input type="checkbox"/>	<input type="checkbox"/>
4. Overland flow to and from adjoining properties not affected	<input type="checkbox"/>	<input type="checkbox"/>
5. Remedial work required? <input type="checkbox"/> Yes (please list) <input type="checkbox"/> No		

.....
Developer

Date

.....
Council

Date.....

F4.7 WETLAND CONSTRUCTION INSPECTION CHECKLIST

- The purpose of this checklist is to document that the wetland construction complies with the design, and construction has conformed to best practice. It does not absolve the contractor from other statutory or best practice requirements not specifically referenced in the checklist.
- This checklist is to be filled in by the wetland designer and/or Council inspecting officer (if present) at any inspections during construction, and at an inspection directly prior to the issuance of practical completion.
- It is to be signed as correct by the wetland designer, Council inspecting officer (if present) and contractor.
- If issues requiring action by the contractor are raised in the checklist, a subsequent inspection is to be carried out, and a second checklist filled out confirming resolution of the issues.
- All checklists are to be sent to Council at completion of construction (following any modifications required after the inspection). The defects liability period will not commence until checklists have been received and approved by Council.

Asset I.D		Inspected by:	
Site:		Date	
		Time	
Constructed by:		Weather	
		Contact during site visit:	

Items Inspected	Checked		Satisfactory		Comments
	Y	N	Y	N	
Preliminary Works					
1. Erosion and sediment control plan adopted					
2. Limit public access					
3. Location same as plans					
4. Site protection from existing flows					
5. All required permits in place					

Post Earthworks					
6. Integrity of banks					
7. Batter slopes as per plans					
8. Impermeable (i.e.					

Post Earthworks					
clay) liner installed as per design					
9. Impermeable liner operating as intended (i.e. no groundwater intrusion)					
10. Maintenance access to whole wetland provided as designed					
11. Maintenance access to forebay provided as designed					
12. Compaction of liner and all embankments as designed					
13. Placement of adequate planting media					
14. Levels as designed for base, benches, banks and spillway (including freeboard)					
15. Stabilisation of exposed earth with grass or similar					
16. Bathymetry constructed as per design to confirm achievement of water quality and quantity objectives.					

Structural components (post earthworks)					
17. Public safety provisions installed as per design (e.g. fencing or thick vegetation around deep water zones to prevent access, appropriate batter slopes, etc.)					
18. Pipe joints and connections as designed					
19. Concrete and reinforcement as designed					
20. Inlets appropriately installed (forebay)					

Structural components (post earthworks)					
21. Inlet energy dissipation installed (forebay)					
22. No seepage through banks					
23. Ensure spillway is level and at designed level					
24. Provisions for dewatering as per design (i.e. manual drainage valve at bottom of riser structure for maintenance)					
25. Collar installed on pipes					
26. Riser structure outlets as per design to confirm achievement of water quality and quantity objectives.					
27. Protection of riser from debris (i.e. scruffy dome)					
28. Bypass channel stabilized (if applicable)					
29. Erosion protection at riser structure outlet pipe & spillway outlets (downstream)					

Vegetation (post earthworks)					
30. Vegetation appropriate to zone (depth)					
31. Weed removal prior to planting					
32. Vegetation layout and densities as designed					
33. By-pass channel vegetated					

COMMENTS ON INSPECTION

--

ACTIONS REQUIRED

--

Wetland Designer signature and date:

--

Council Inspection officer signature and date (if present):

--

Contractor signature and date:

--

F4.8 WETLAND AND PONDS INSPECTION/SIGNOFF CHECKLIST

For completion by Developer prior to requesting:

1. 224c approval
2. First defects liability inspection
3. Final defects liability inspection
4. Remedial works completion inspection

Location: _____

Plan No. : _____

	Date	Date	Date	Date
Type of Inspection (record 1,2,3 or 4)				
	Tick if satisfactory	Tick if satisfactory	Tick if satisfactory	Tick if satisfactory
Pre-inspection	<input type="checkbox"/>	<input type="checkbox"/>	<input type="checkbox"/>	<input type="checkbox"/>
1) Final as-built plans sent to Council	<input type="checkbox"/>	<input type="checkbox"/>	<input type="checkbox"/>	<input type="checkbox"/>
2) Checklists completed for all pipelines and manholes	<input type="checkbox"/>	<input type="checkbox"/>	<input type="checkbox"/>	<input type="checkbox"/>
3) Planting Plan approved by Council	<input type="checkbox"/>	<input type="checkbox"/>	<input type="checkbox"/>	<input type="checkbox"/>
Site Meeting				
1) Forebay accessible and has all weather access	<input type="checkbox"/>	<input type="checkbox"/>	<input type="checkbox"/>	<input type="checkbox"/>
2) Forebay clear of sludge	<input type="checkbox"/>	<input type="checkbox"/>	<input type="checkbox"/>	<input type="checkbox"/>
3) Boundary pegs sighted	<input type="checkbox"/>	<input type="checkbox"/>	<input type="checkbox"/>	<input type="checkbox"/>
4) Works align with as built plans	<input type="checkbox"/>	<input type="checkbox"/>	<input type="checkbox"/>	<input type="checkbox"/>
5) Spillway/s clear of obstruction	<input type="checkbox"/>	<input type="checkbox"/>	<input type="checkbox"/>	<input type="checkbox"/>
6) Erosion and soil stability	<input type="checkbox"/>	<input type="checkbox"/>	<input type="checkbox"/>	<input type="checkbox"/>
7) Inlet and outlet has structural integrity	<input type="checkbox"/>	<input type="checkbox"/>	<input type="checkbox"/>	<input type="checkbox"/>
8) Plants at least 2.0 m clear of inlet and outlet	<input type="checkbox"/>	<input type="checkbox"/>	<input type="checkbox"/>	<input type="checkbox"/>
9) Planting done to approved planting plan	<input type="checkbox"/>	<input type="checkbox"/>	<input type="checkbox"/>	<input type="checkbox"/>
10) Plant density (approx. 1 per m ²)	<input type="checkbox"/>	<input type="checkbox"/>	<input type="checkbox"/>	<input type="checkbox"/>
11) Plants in good condition	<input type="checkbox"/>	<input type="checkbox"/>	<input type="checkbox"/>	<input type="checkbox"/>
12) No plant pests	<input type="checkbox"/>	<input type="checkbox"/>	<input type="checkbox"/>	<input type="checkbox"/>
13) Weed (%) compliant with ITS	<input type="checkbox"/>	<input type="checkbox"/>	<input type="checkbox"/>	<input type="checkbox"/>
14) No notifiable weeds	<input type="checkbox"/>	<input type="checkbox"/>	<input type="checkbox"/>	<input type="checkbox"/>
15) Plants sourced from Waikato Ecological District	<input type="checkbox"/>	<input type="checkbox"/>	<input type="checkbox"/>	<input type="checkbox"/>
16) Safety Features	<input type="checkbox"/>	<input type="checkbox"/>	<input type="checkbox"/>	<input type="checkbox"/>
All works satisfactory	<input type="checkbox"/>	<input type="checkbox"/>	<input type="checkbox"/>	<input type="checkbox"/>

Remedial work required:

.....
Developer

Date

.....
Council

Date.....

DRAWINGS

Table 4-43: Drawings

DRAWING NO.	TITLE
D4.1	Bubble Up Pit
D4.2	Kerb Connection
D4.3	100mm Diameter Stormwater Outlet
D4.4	Stormwater Secondary Flow Path Treatment – Private Property
D4.5	Groundwater Recharging Devices
D4.6	Footpath Berm Catchpit Details
D4.7	Catchpit Back Entry Details
D4.8	Double Sump Catchpit Design
D4.9	Vertical Entry Catchpit
D4.10	Fish Symbols for Catchpits
D4.11	Swale Plan and Section
D4.12	Swale Driveway Crossing Detail
D4.13	Rain Garden Plan and Underdrain Long Section
D4.14	Rain Garden Detention/Soakage Cross Sections and Kerb Detail
D4.15	Underground Storage with approved Catchpit Filter Plan and Cross Section
D4.16	Underground Storage with approved Catchpit Filter Long Section
D4.17	Underground Storage with Gross Pollutant Trap Long Section
D4.18	Stormwater Connection Layouts
D4.19	Deleted.
D4.20	Deleted.
D4.21	DN1050 – DN1350 Manholes
D4.22	Typical Dimensions for Manholes Greater than DN1350
D4.23	Shallow Manhole/Chamber
D4.24	Lateral Connection
D4.25	Anti-Scour Blocks for Steep Drainage Pipes

D4.26 [Building Over and Adjacent to Public Wastewater or Stormwater Pipelines](#)

D4.27 [Stormwater Device Information Sign Board](#)

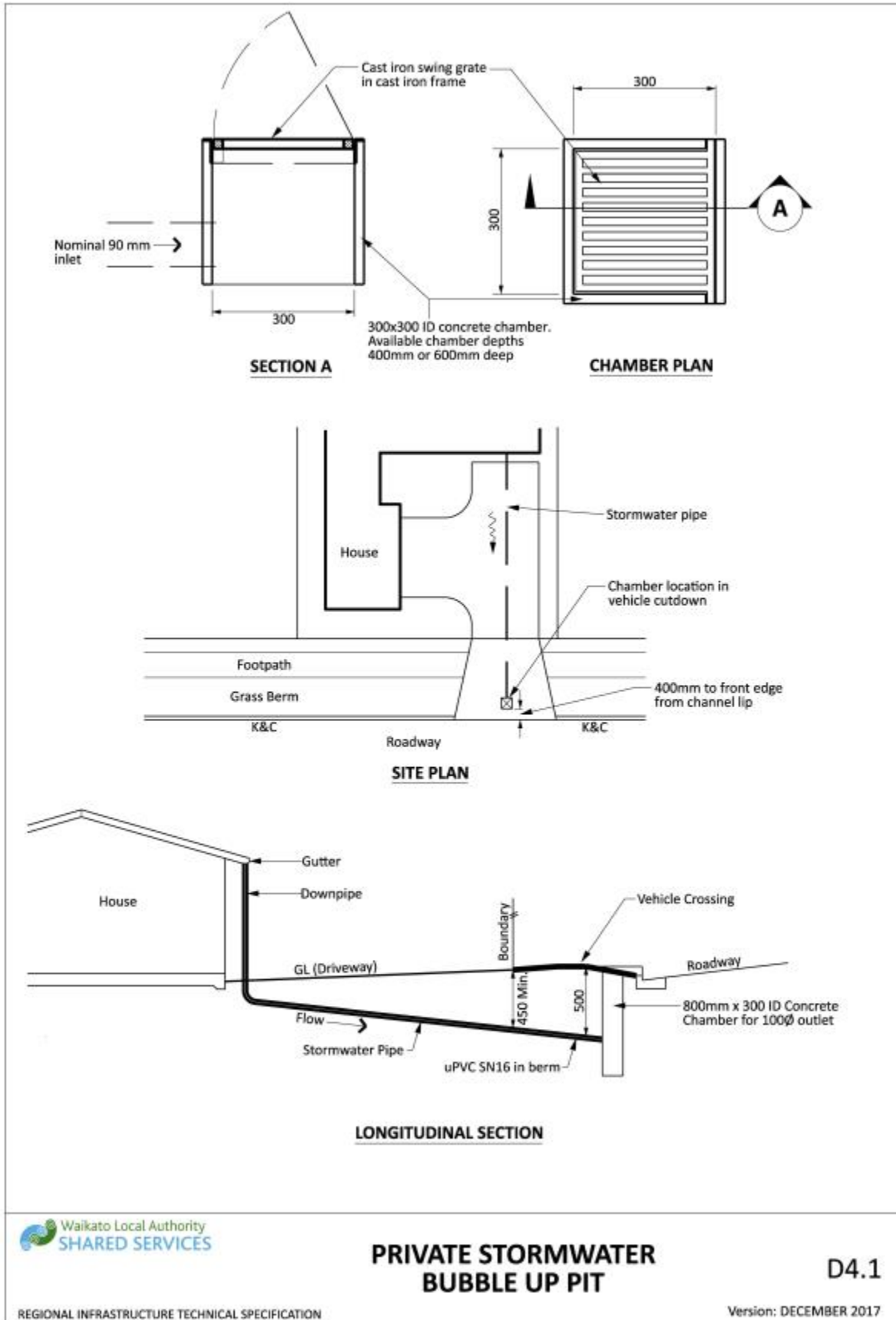

Drawing 4-10: Private stormwater bubble up pit

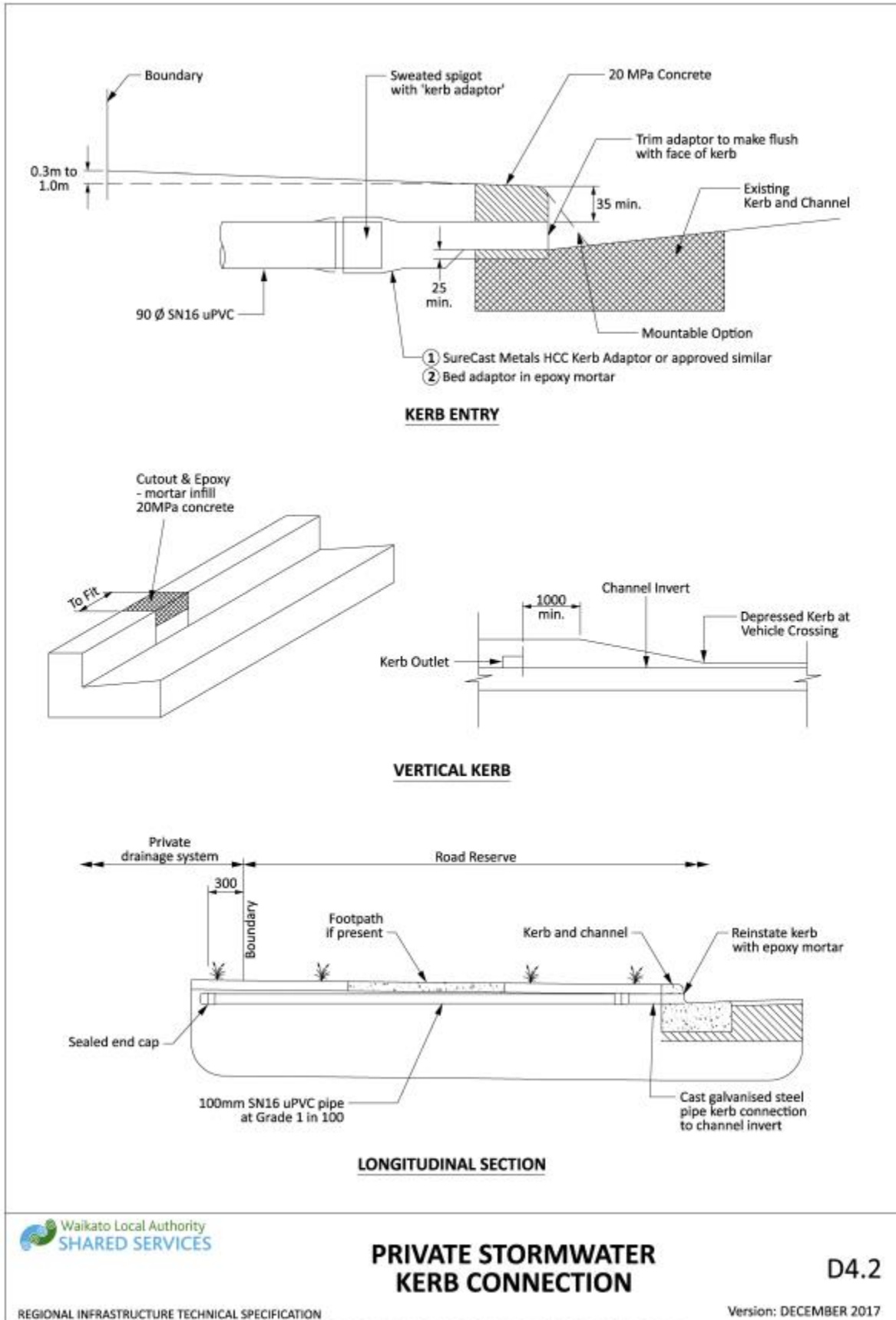

Drawing 4-11: Private stormwater kerb connection

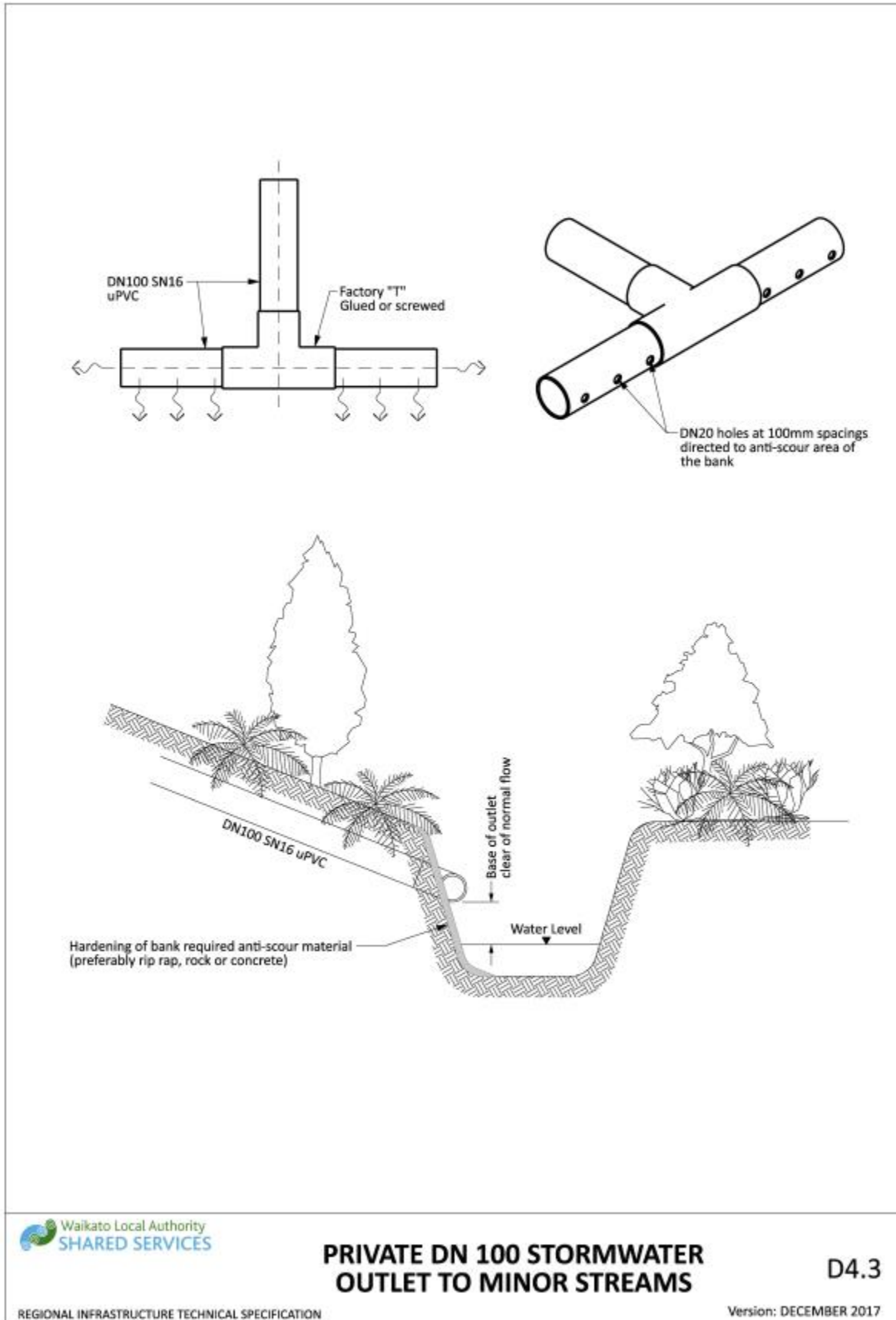

Drawing 4-12: Private DN 100 stormwater outlet to minor streams

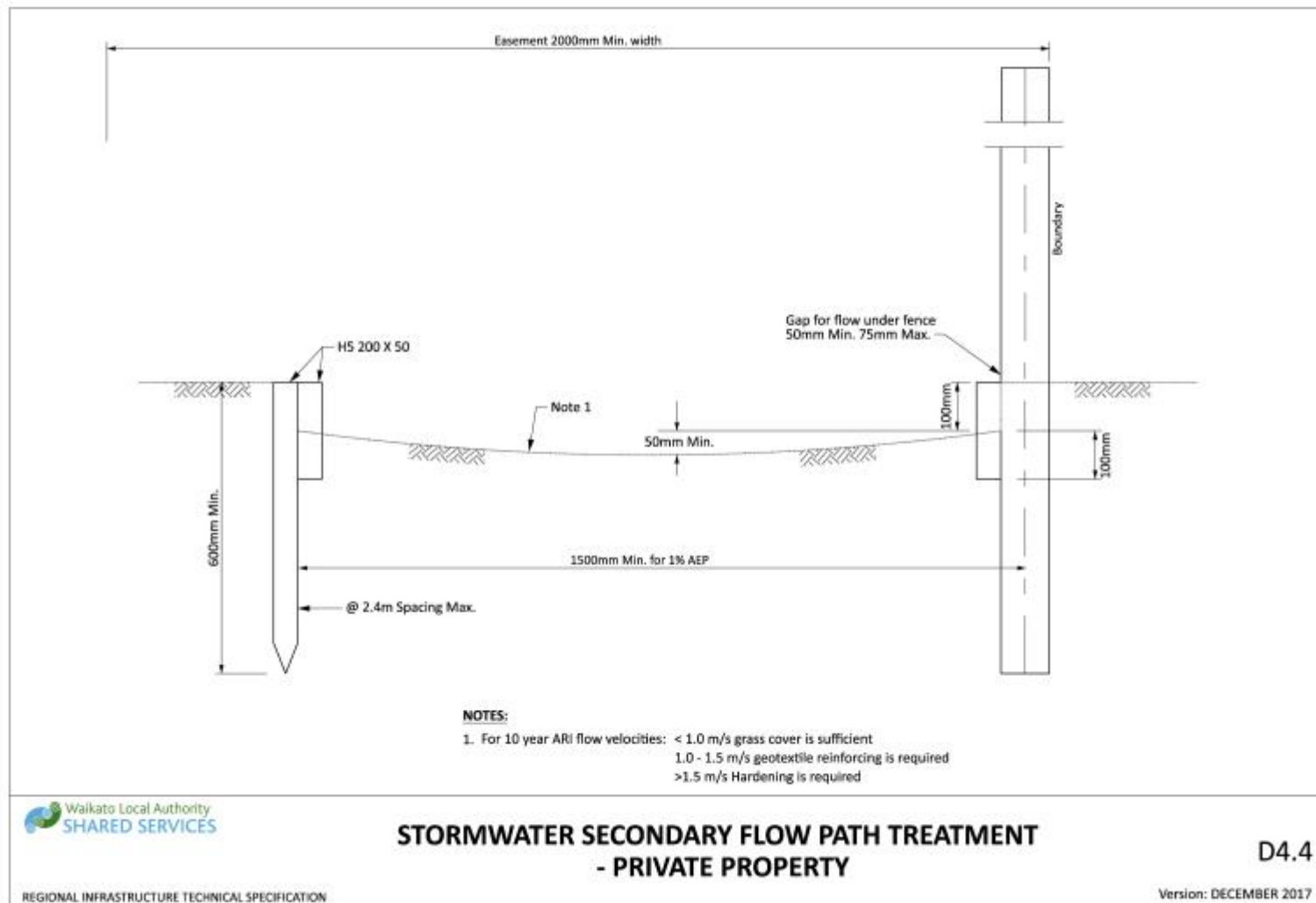

Drawing 4-13: Stormwater secondary flow path treatment - private property

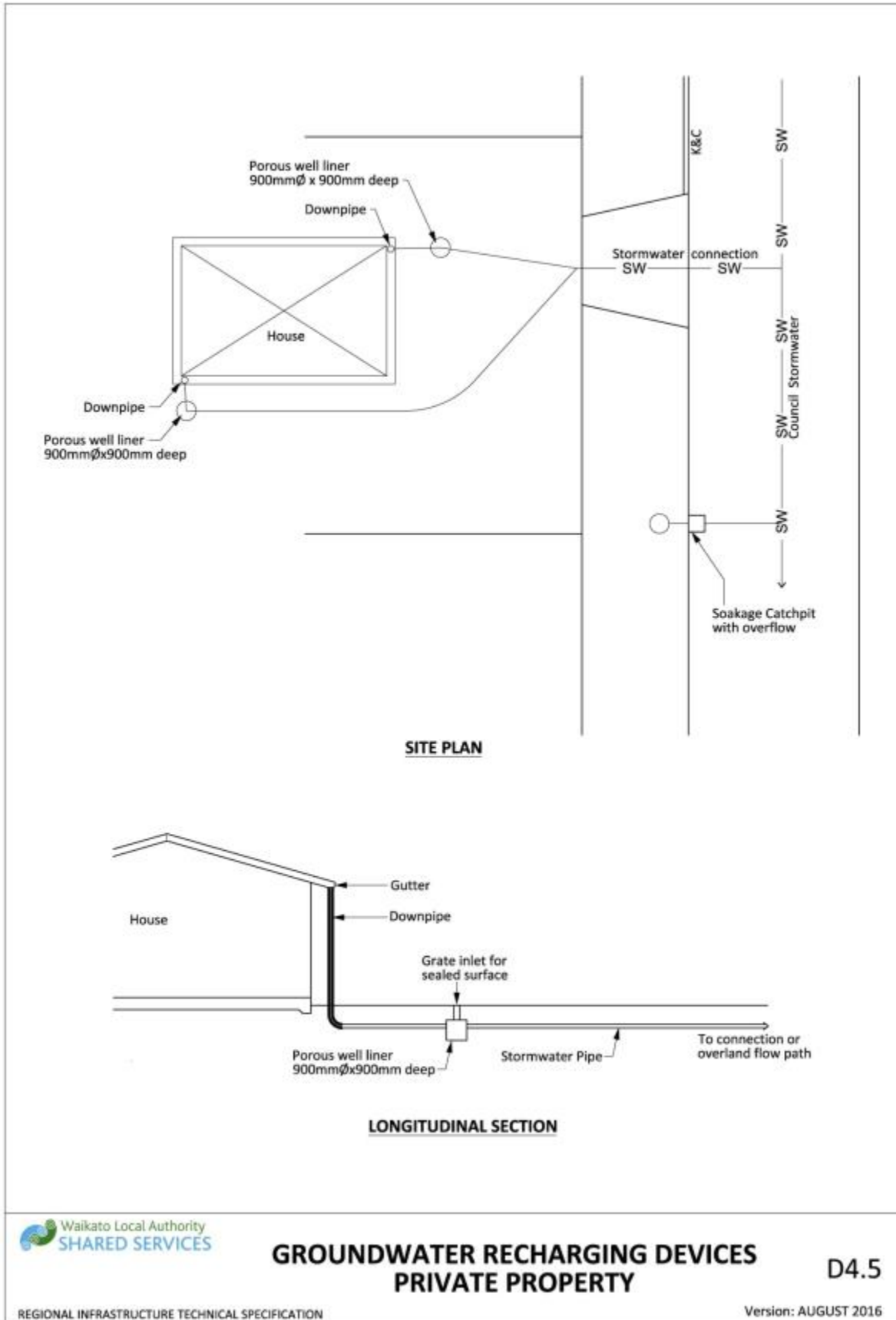

Drawing 4-14: Groundwater recharging devices private property

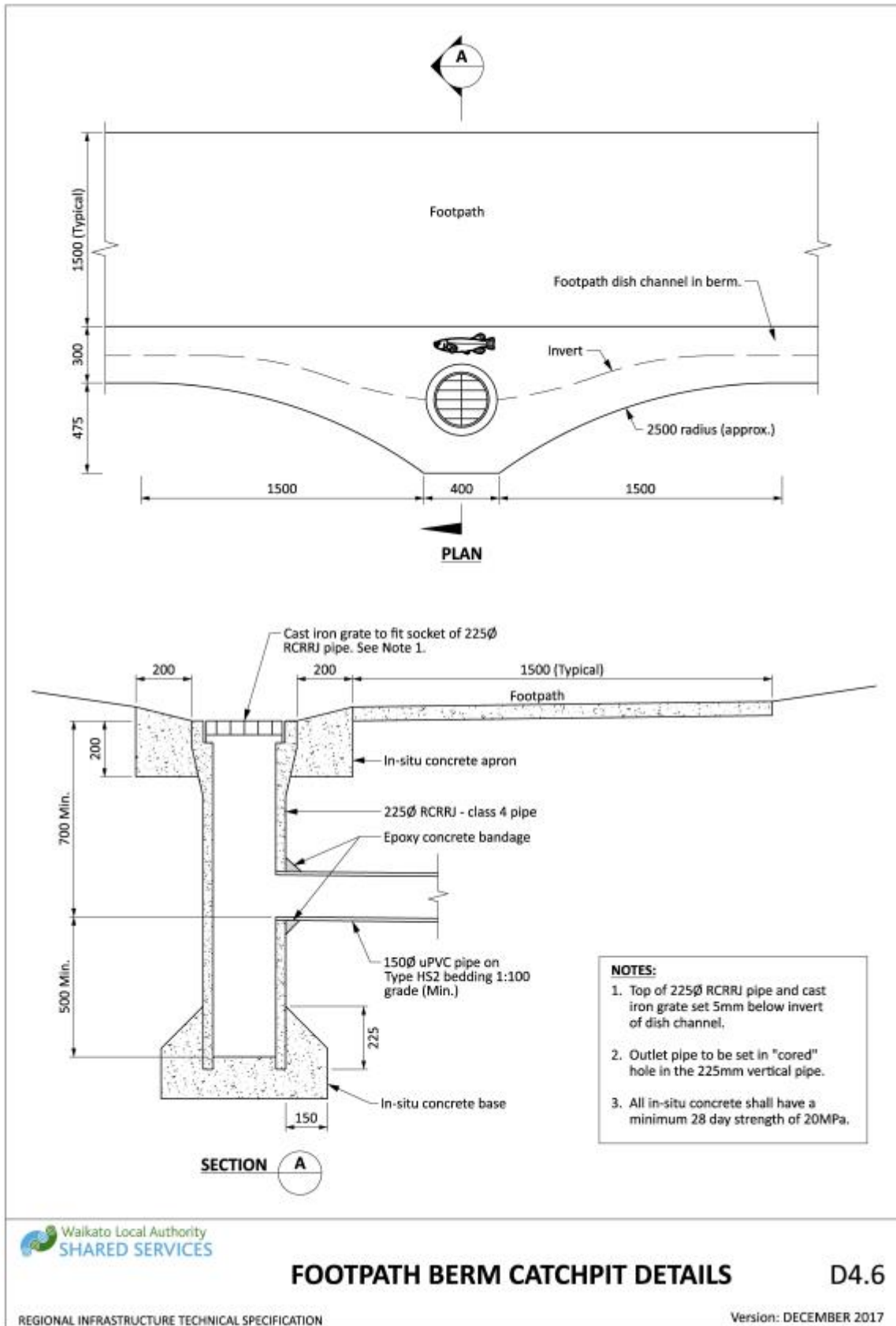

Drawing 4-15: Footpath berm catchpit details

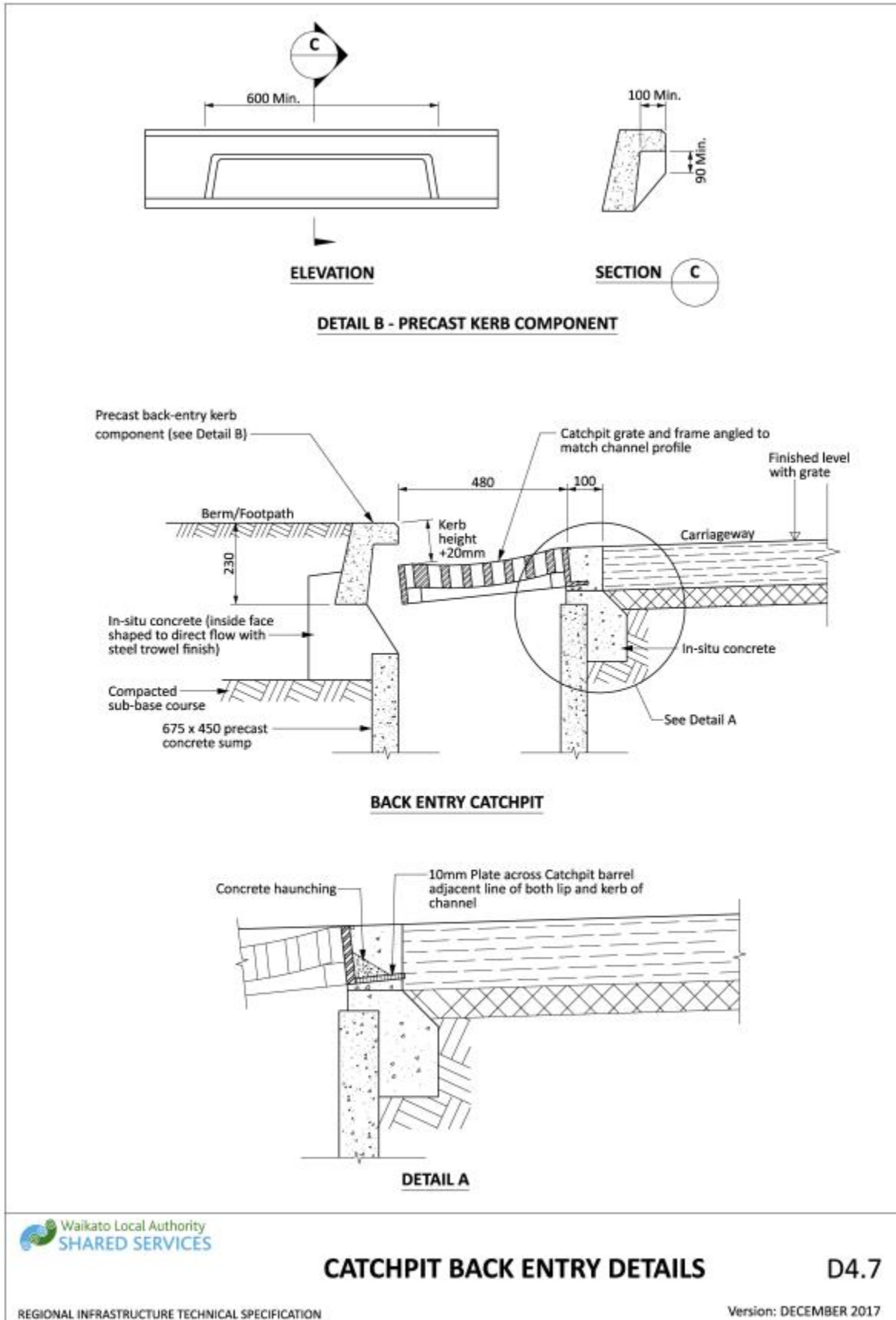

Drawing 4-16: Catchpit back entry details

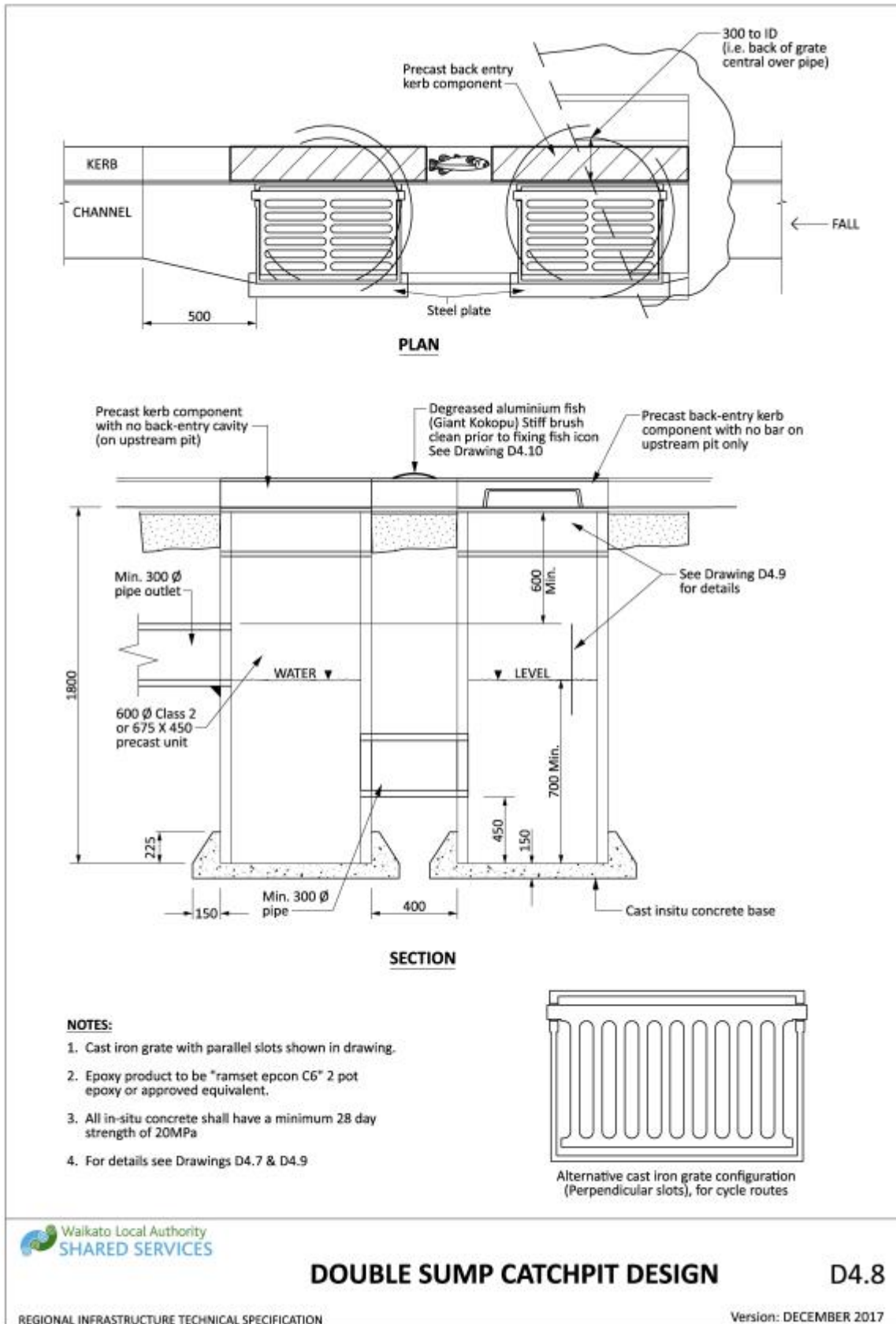

Drawing 4-17: Double sump catchpit design

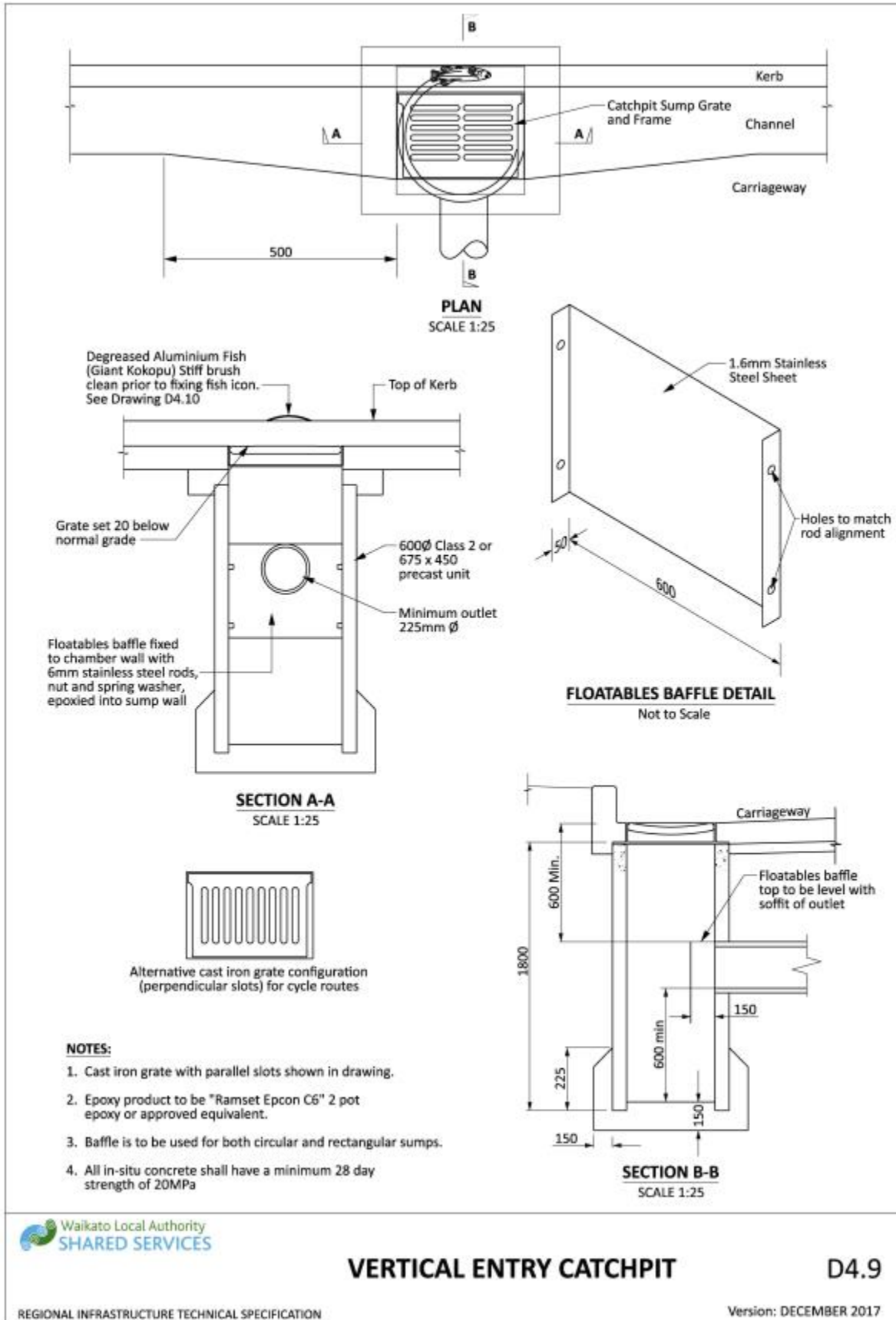

Drawing 4-18: Vertical entry catchpit

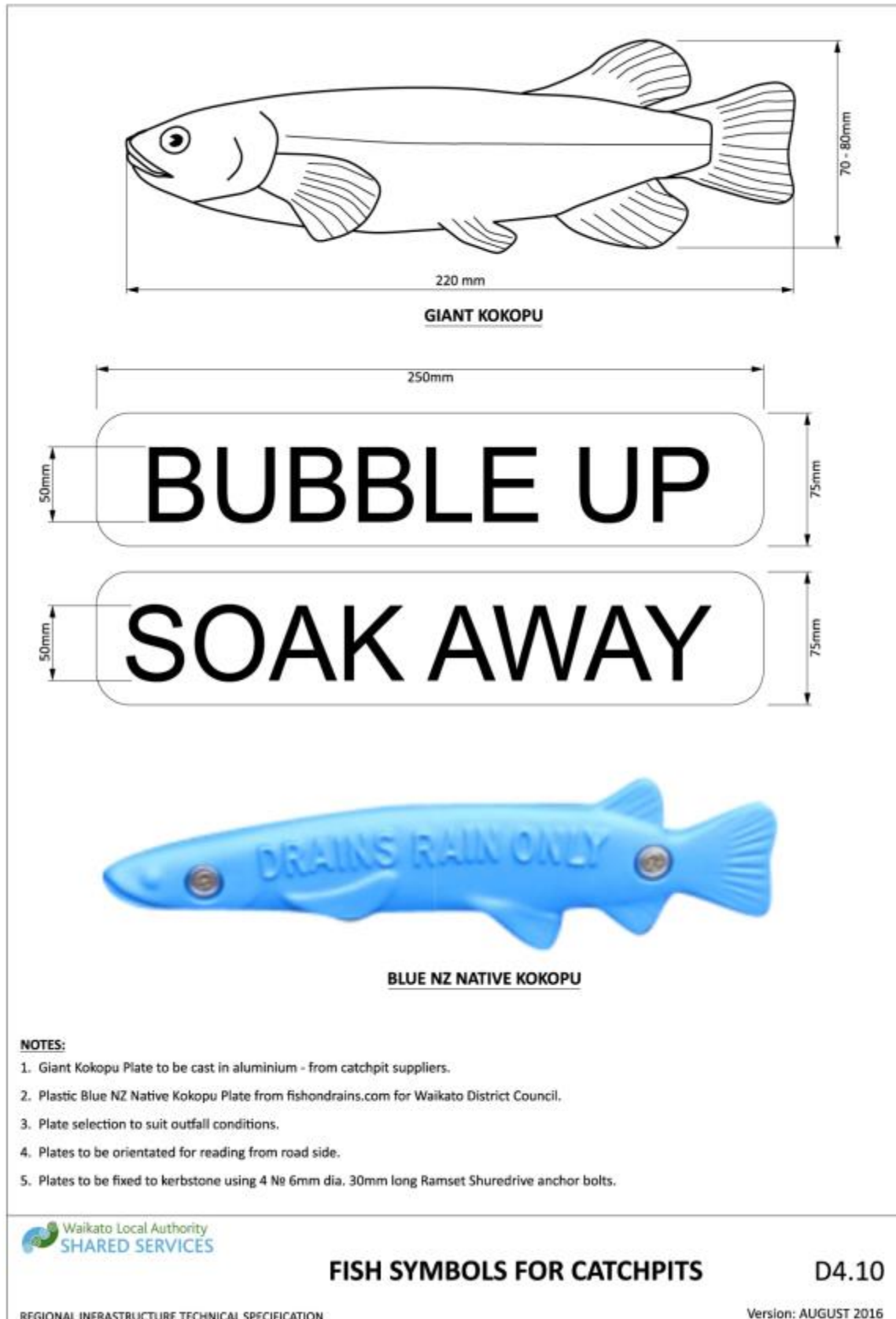

Drawing 4-19: Fish symbols for catchpits

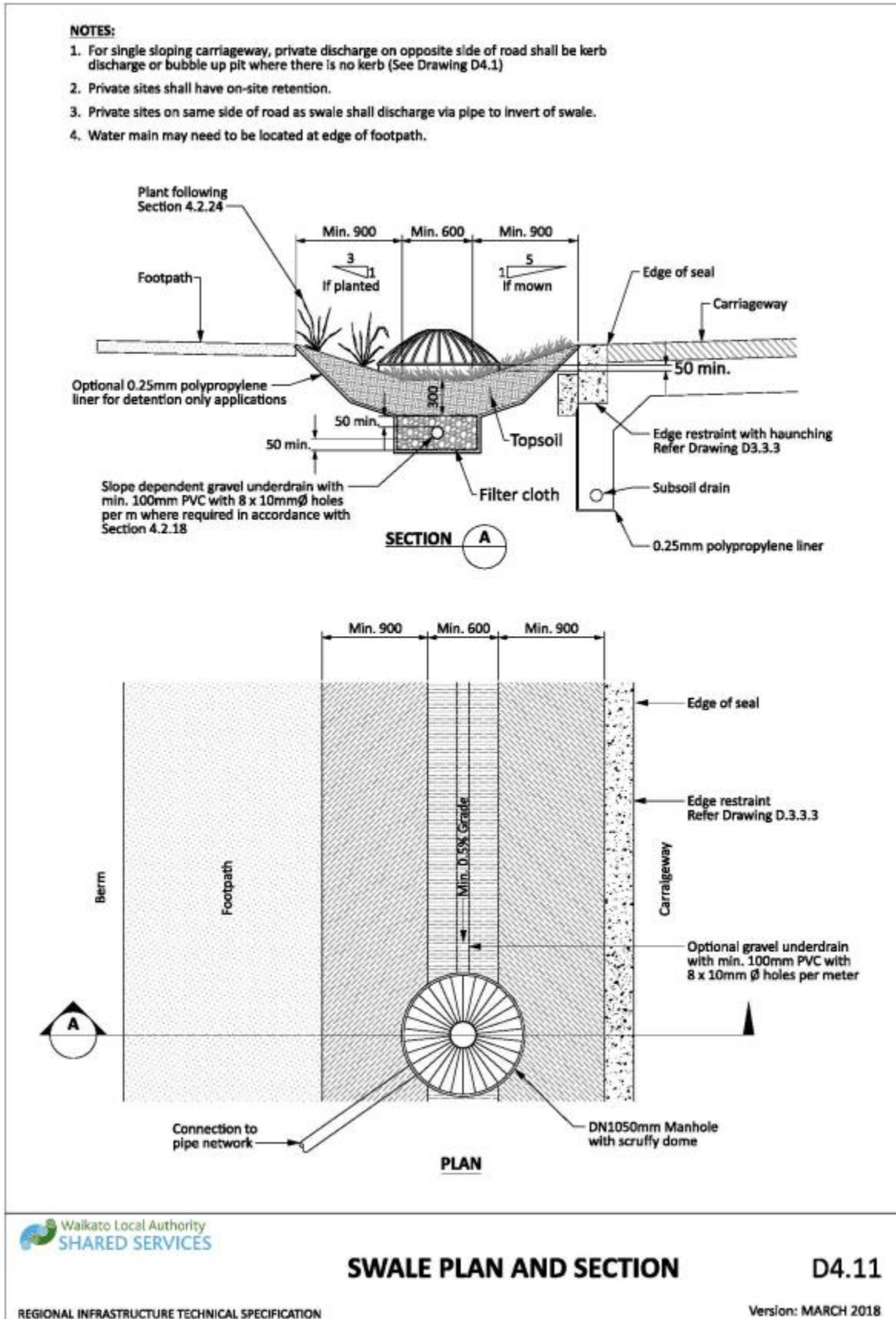

Drawing 4-20: Swale plan and section

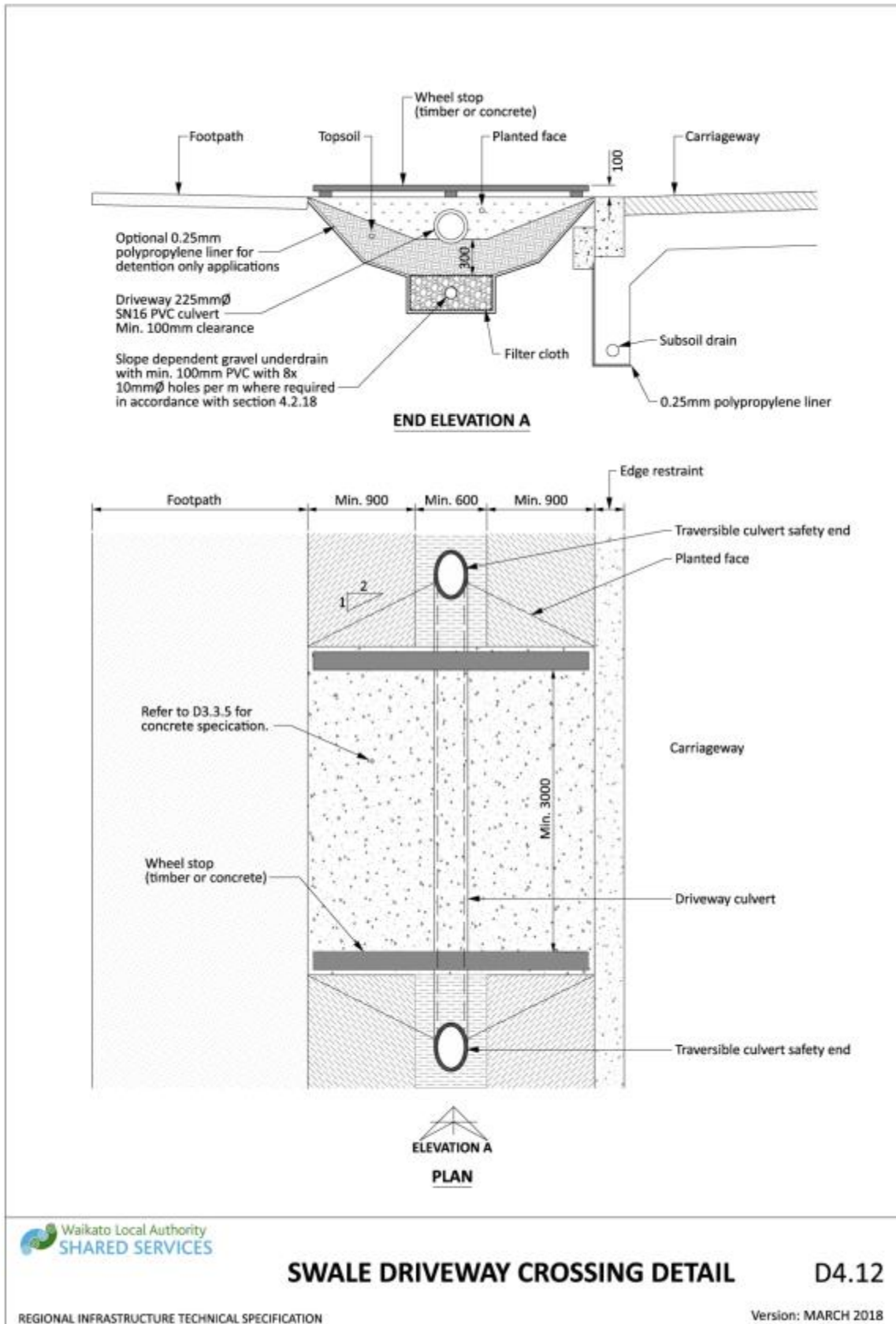

Drawing 4-21: Swale driveway crossing detail

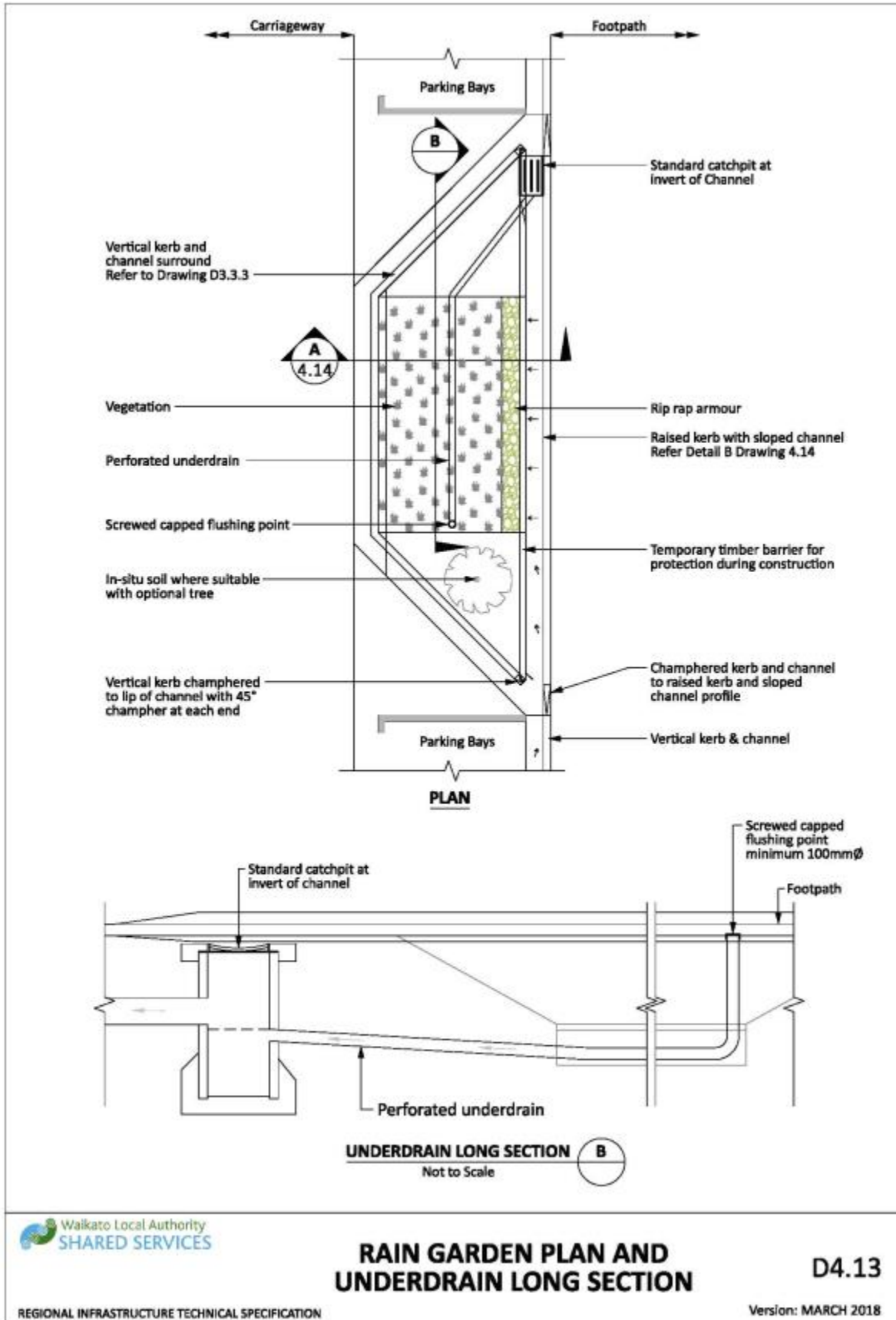

Drawing 4-22: Rain garden plan and underdrain long section

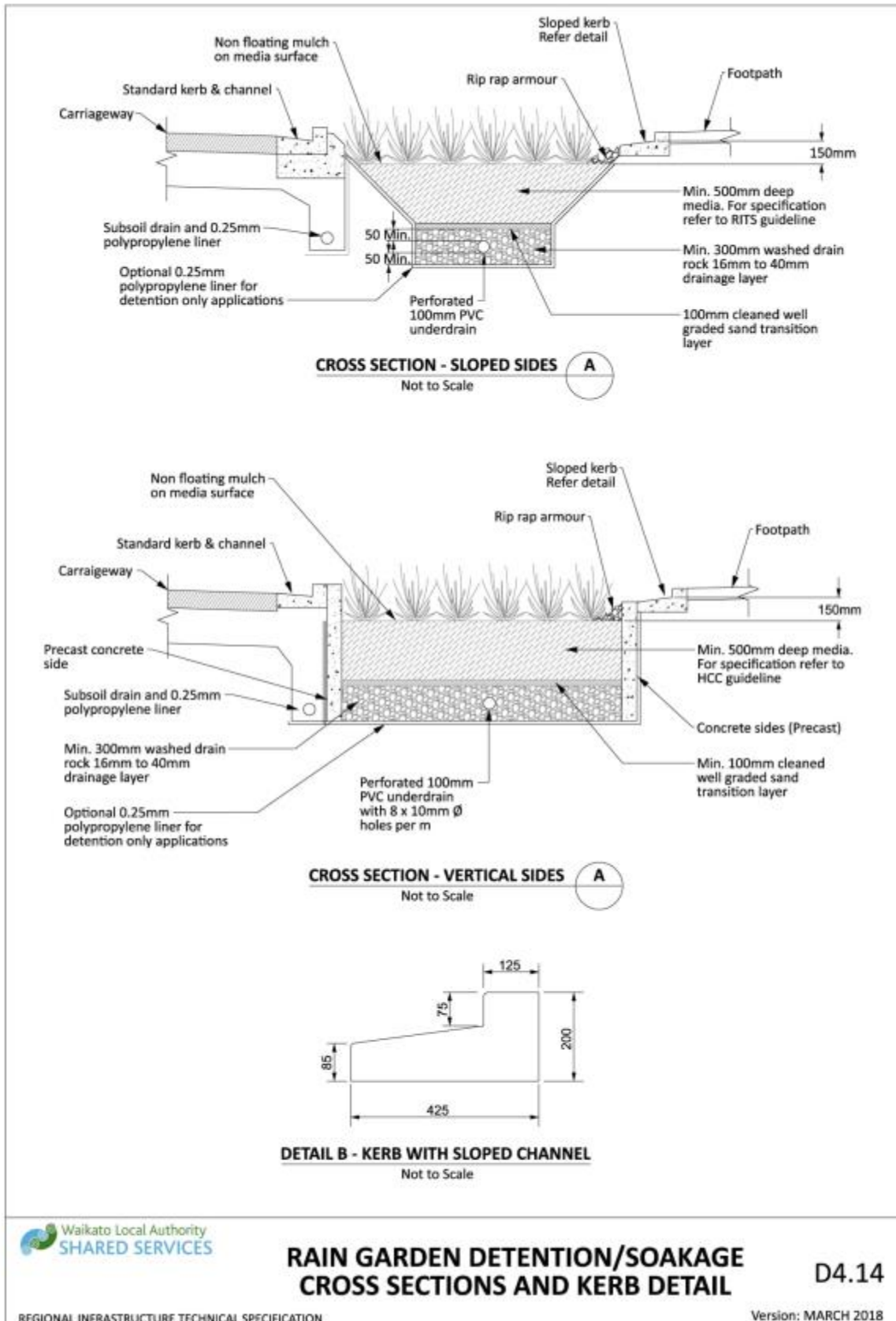

Drawing 4-23: Rain garden detention/soakage cross sections and kerb detail

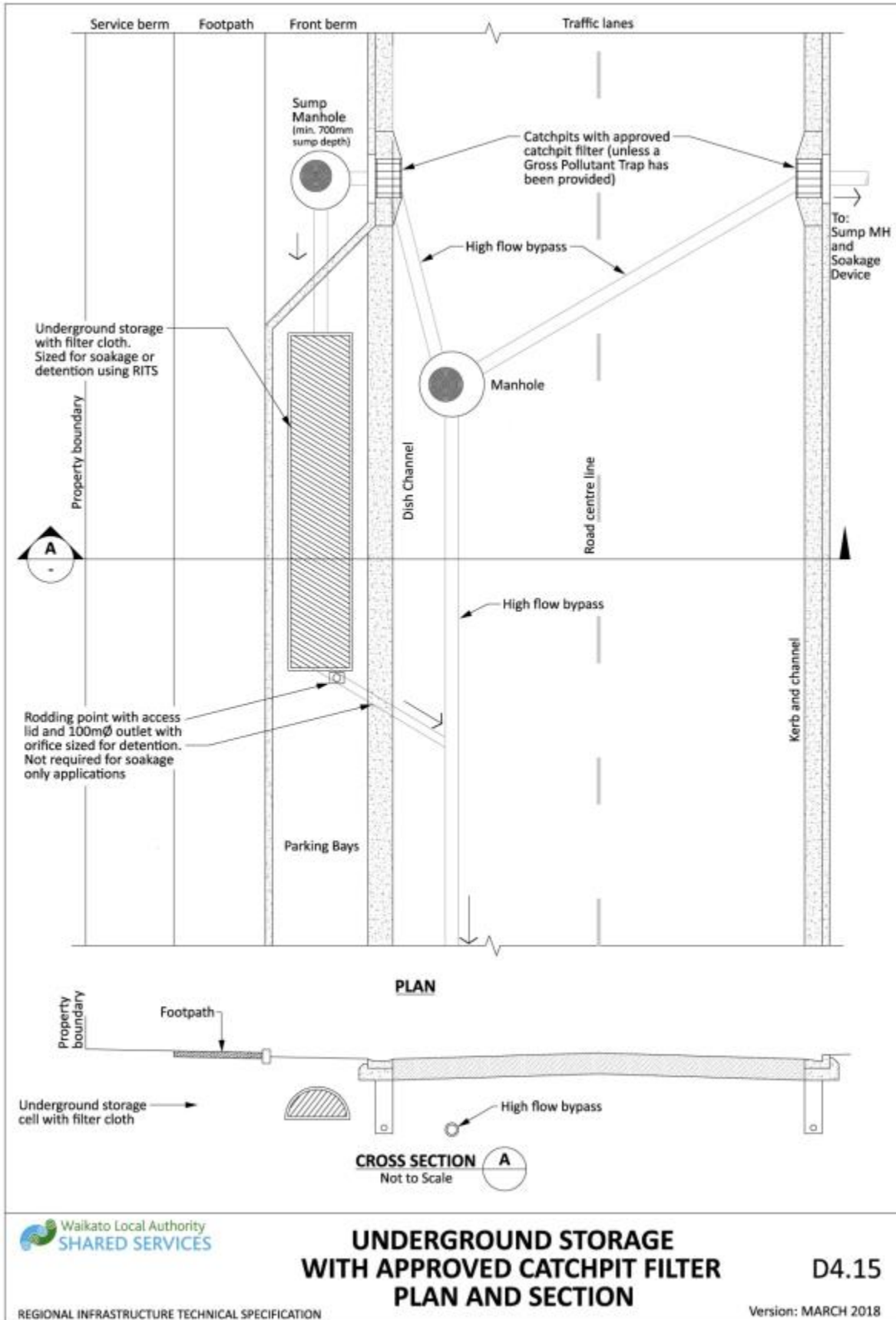

Drawing 4-24: Underground storage with approved catchpit filter plan and section

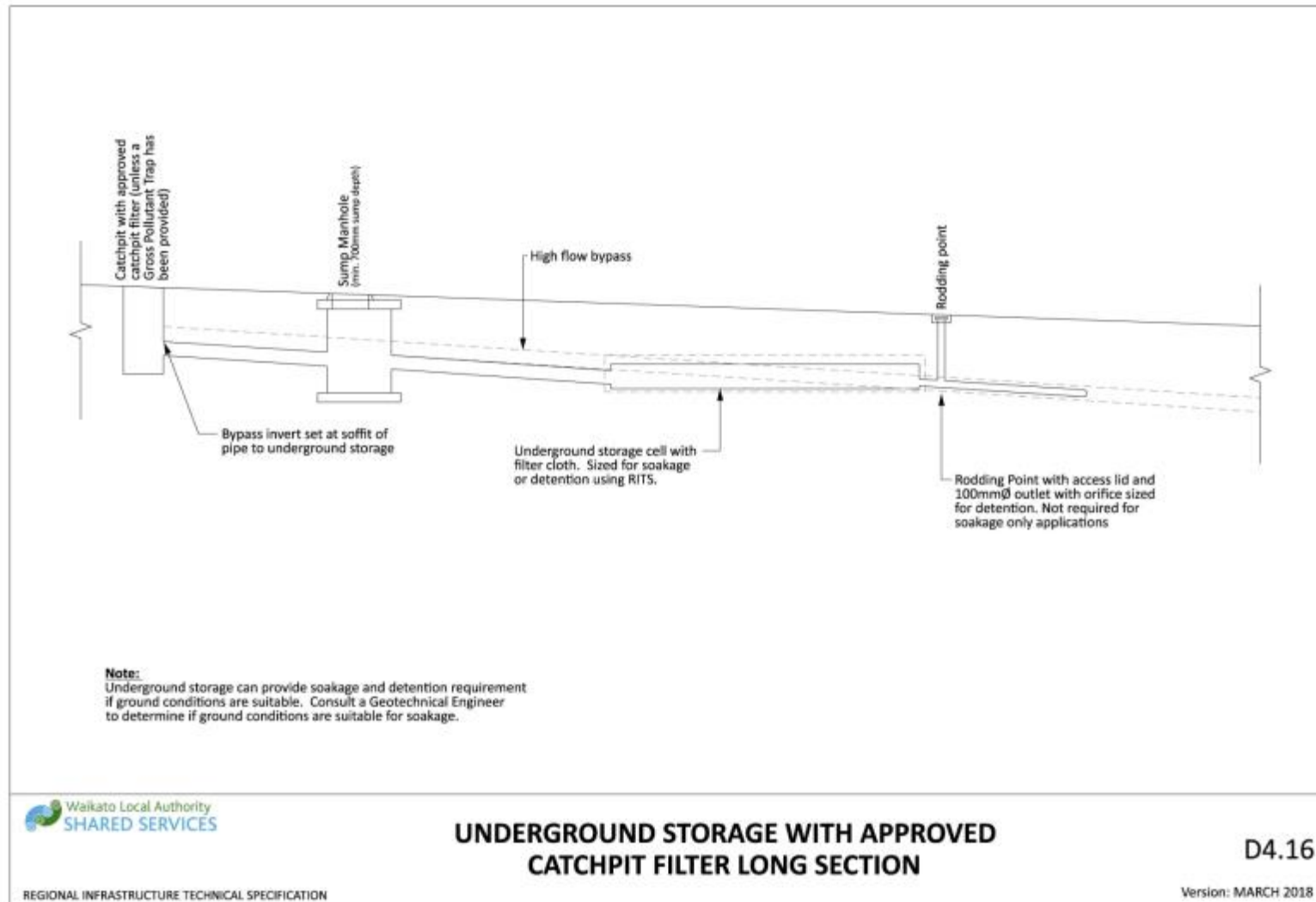

Drawing 4-25: Underground storage with approved catchpit filter long section

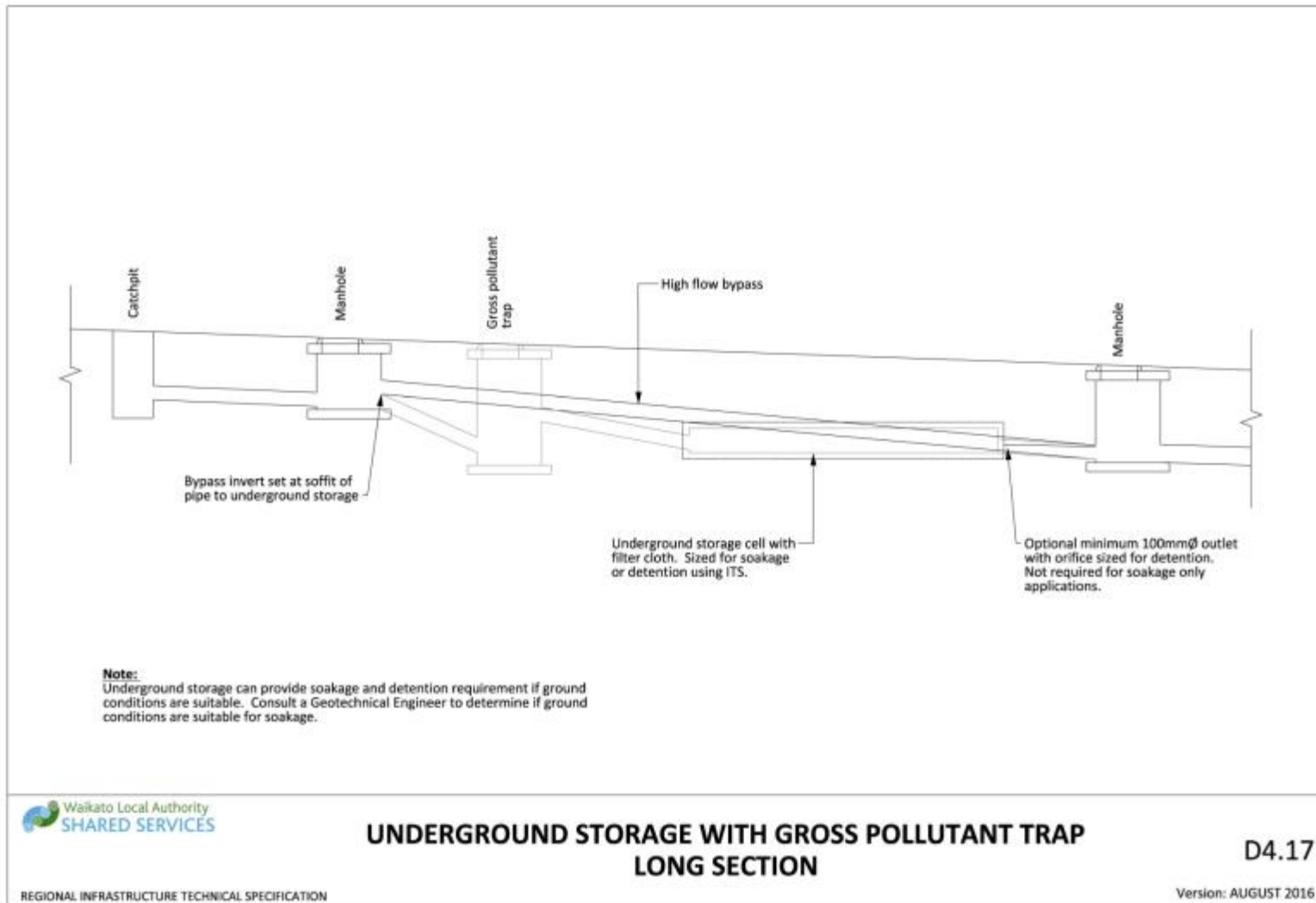

Drawing 4-26: Underground storage with gross pollutant trap long section

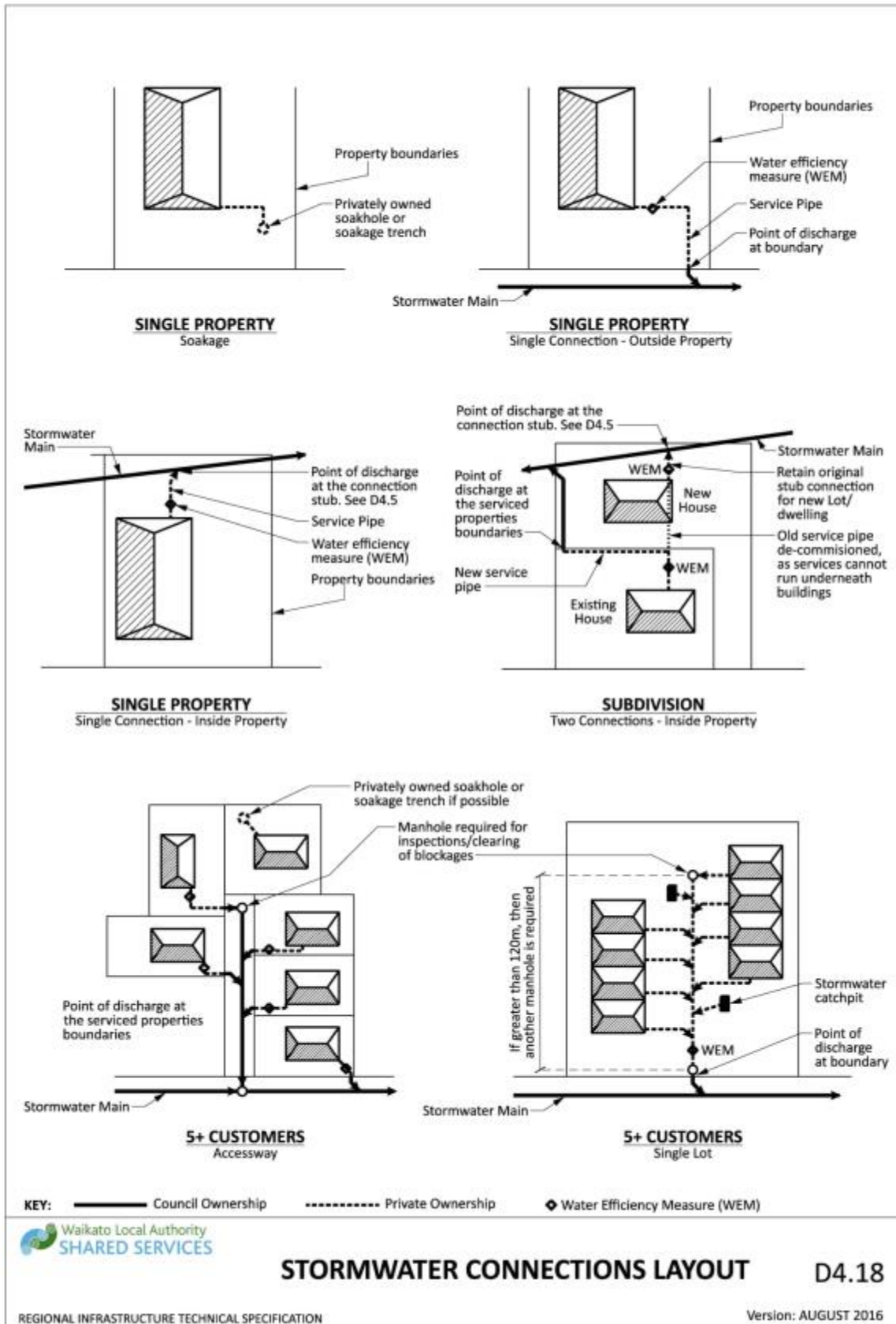

Drawing 4-27: Stormwater connections layout

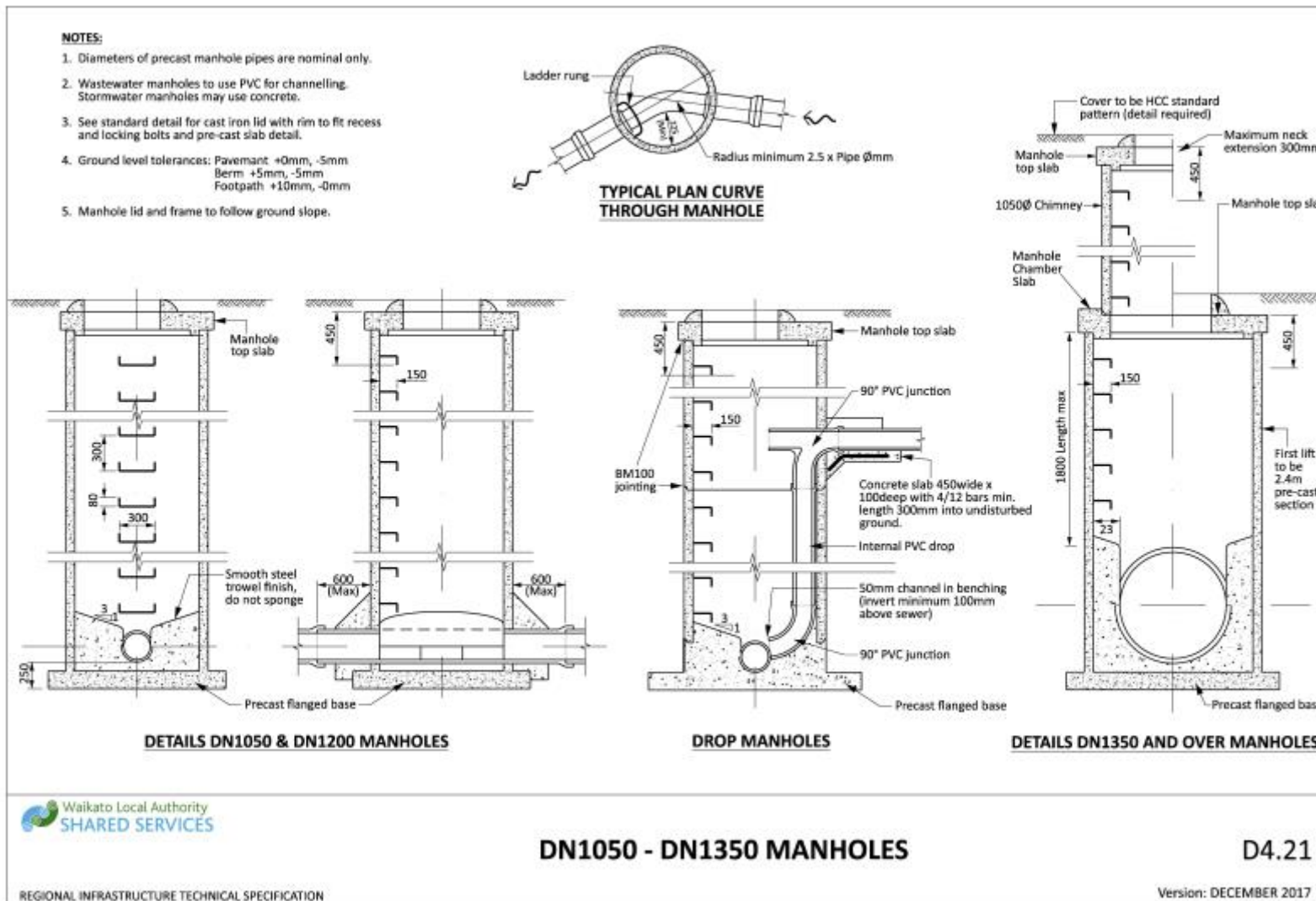

Drawing 4-28: DN1050 manholes

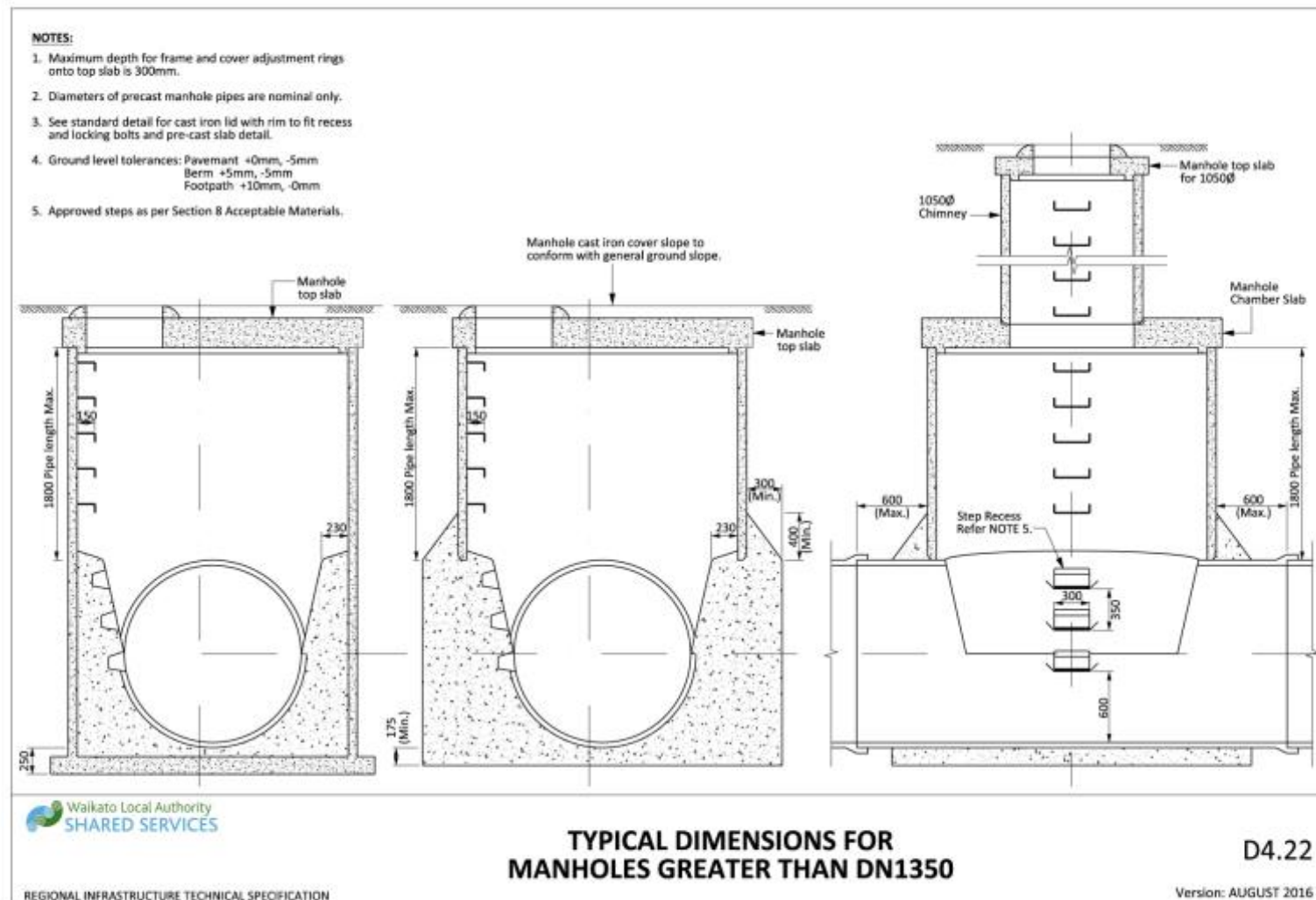

Drawing 4-29: Typical dimensions for manholes greater than DN1350

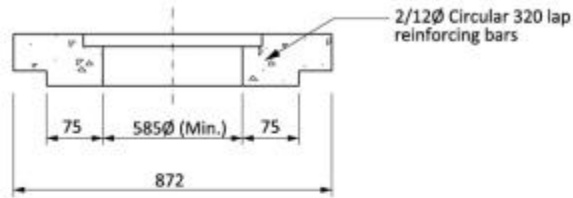

TOP SLAB FOR DN750 SHALLOW CHAMBER

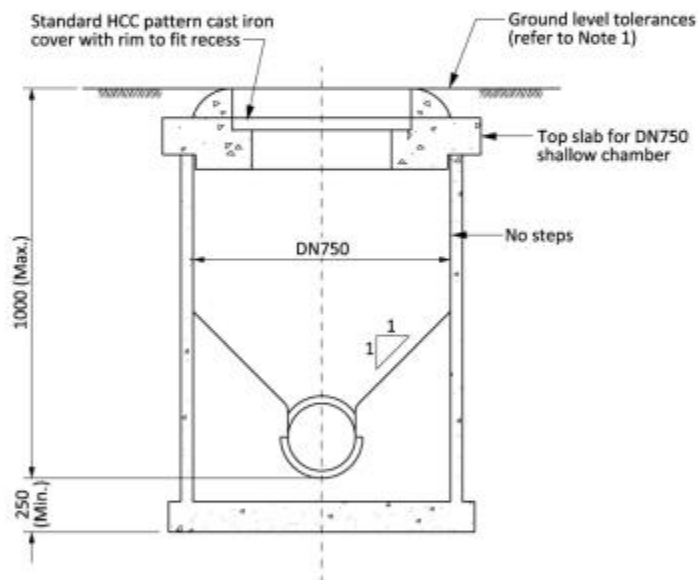

DN750 INTERNAL SHALLOW CHAMBER

To be used only on pipes of DN100 to DN300 and where depth of invert is less than 1000mm

NOTES:

1. Ground level tolerances: Pavement +0mm, -5mm
 Berm +5mm, -5mm
 Footpath +10mm, -0mm



SHALLOW MANHOLE/CHAMBER

D4.23

Drawing 4-30: Shallow manhole/chamber

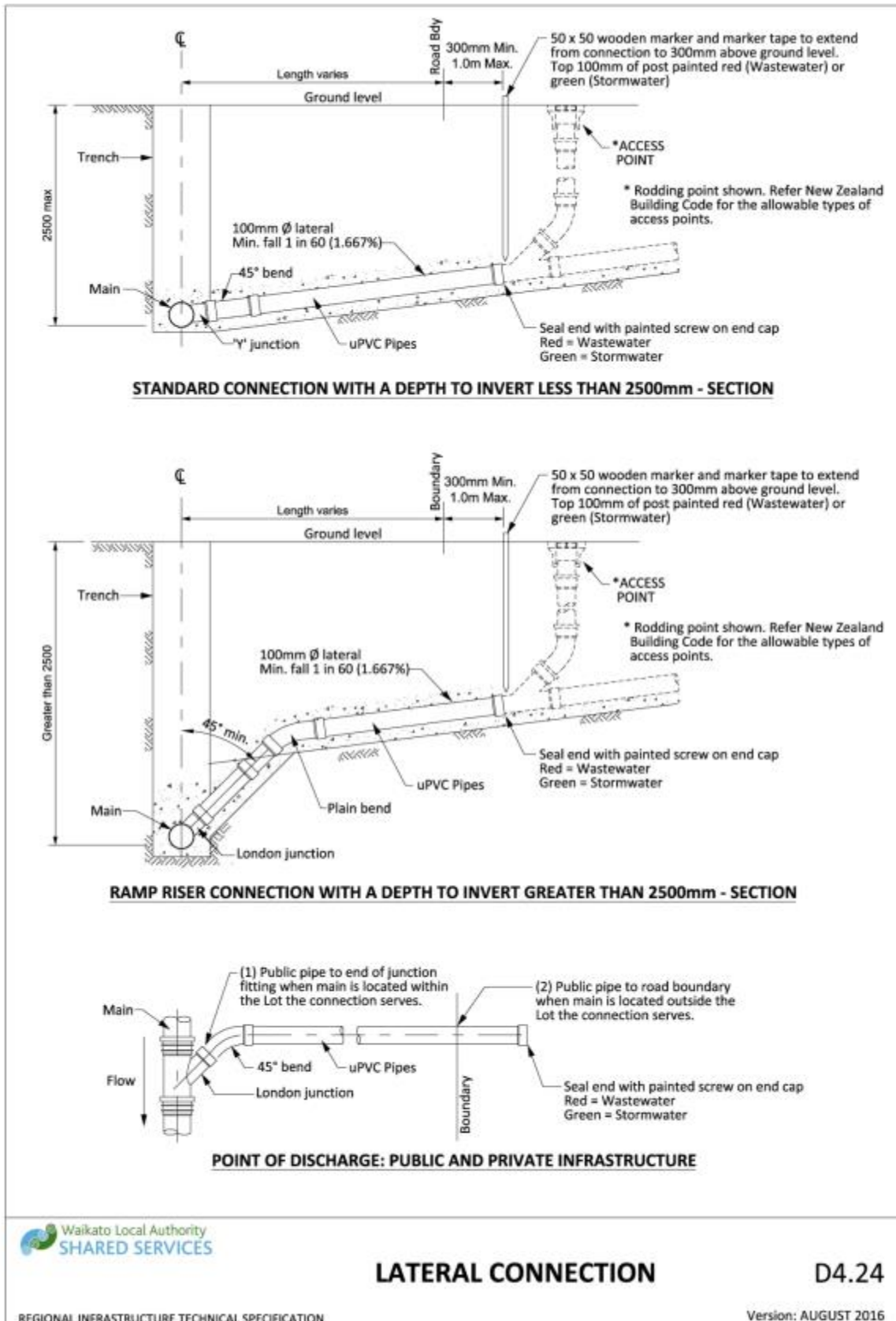

Drawing 4-31: Lateral connection

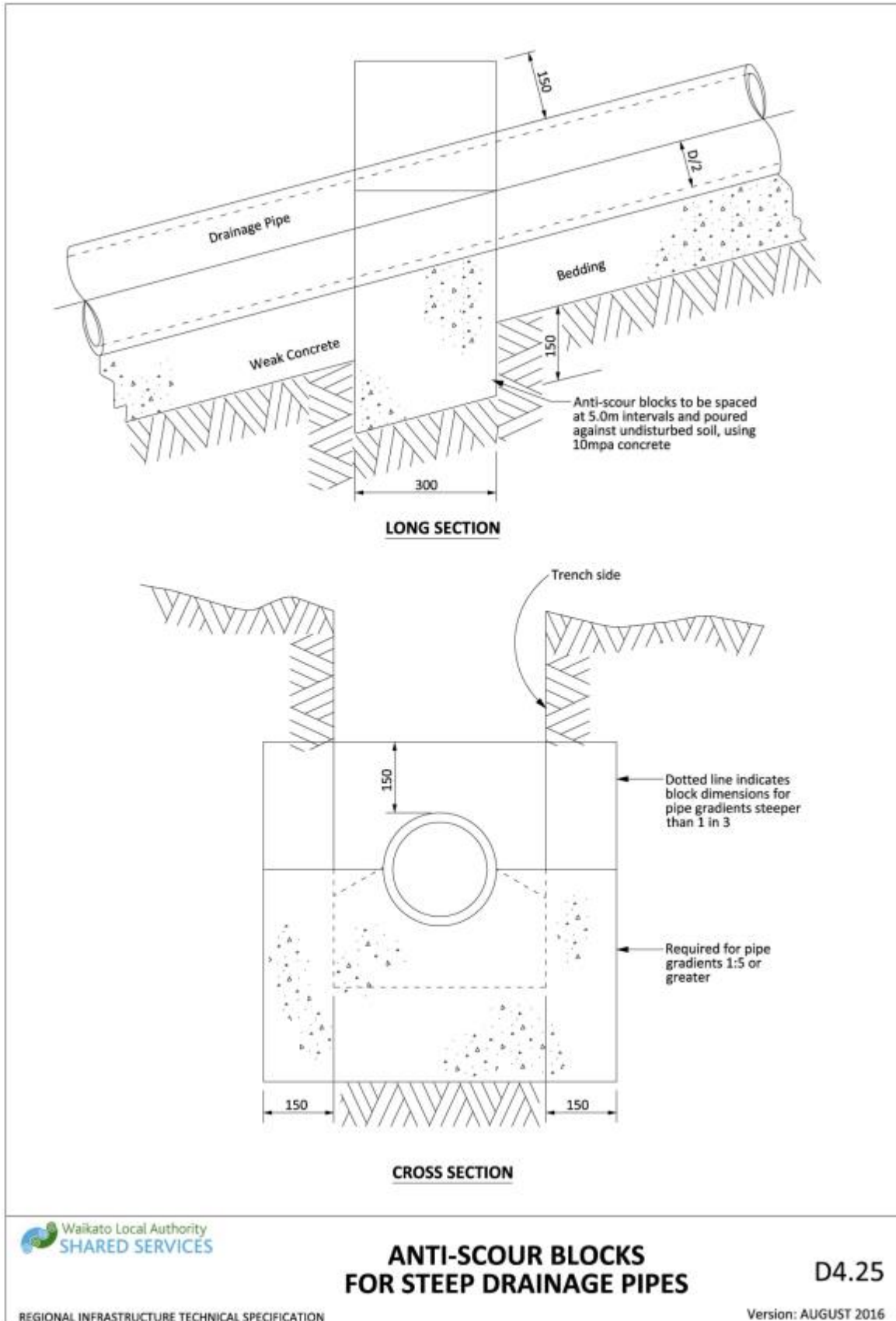

Drawing 4-32: Anti-scour blocks for steep drainage pits

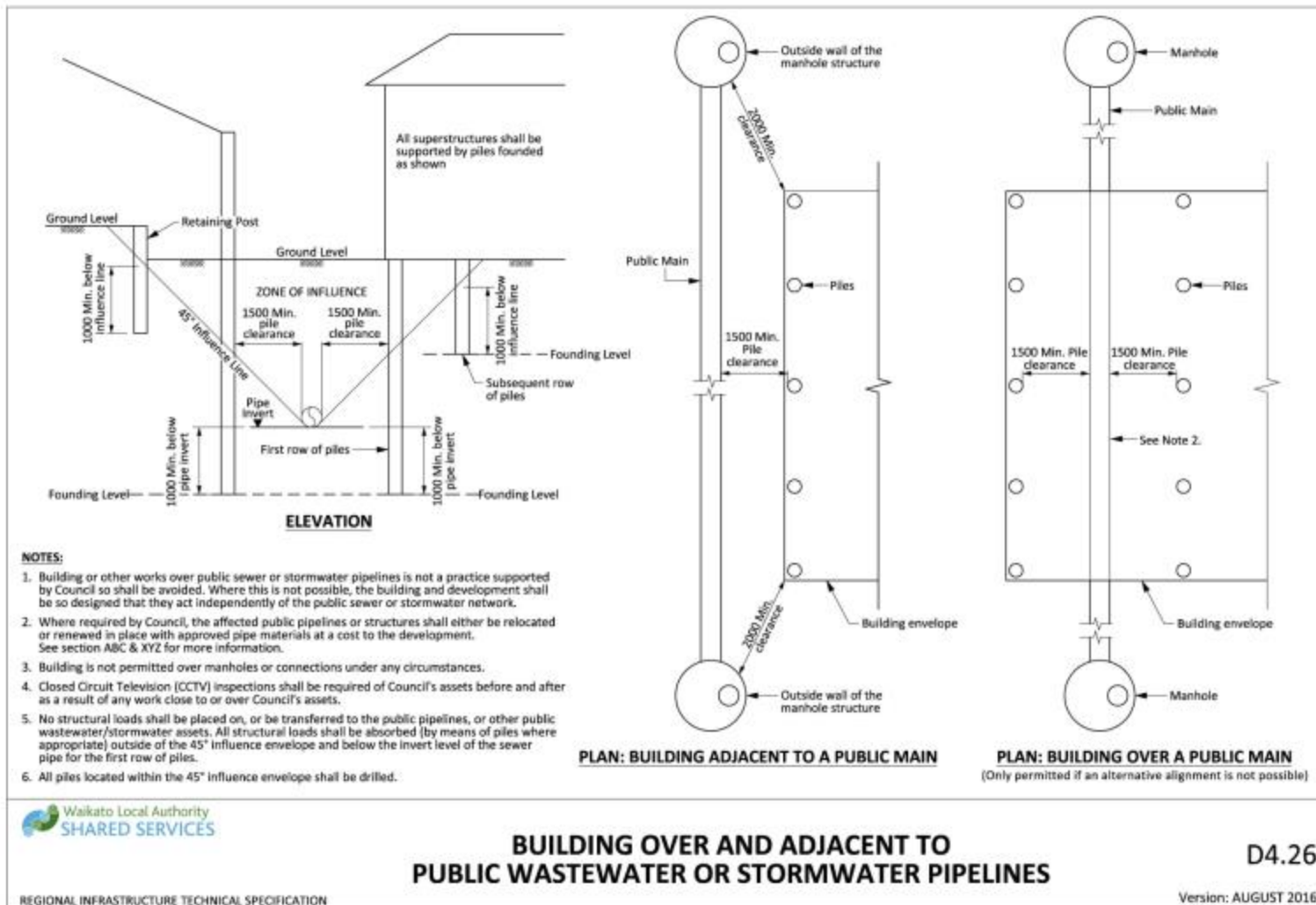

Drawing 4-33: Building over and adjacent to public wastewater or stormwater pipelines

Whale Park

Stormwater system

Why treat stormwater?
When it rains, stormwater runs off roof tops, roads, carparks, industrial areas and parks. It may look clean, but it can be dirty and may contain pollutants such as heavy metals, sediment, nutrients, oil and grease. This stormwater device has been designed to:

- reduce flooding
- manage the water quality entering and exiting our waterways and ecosystems.

Te Paaka Tohoraa Ei te tauriri aua awhetau

Te take hei whakahaumanu i te wai aawhaa?
Ei te hēti te wai aawhaa i ngā taunui, roki, wāhi tauriri waka, wāhi ahunga me ngā paaka. Tōna āhio he mā te wai, ngāi anō pā hā piriā o ngā pāu whakakō, kōngamū taunaha, pāwā, ngā hā me ngā mōro hāu. Kā hāngi tōna pūnaha hei:

- whakahaere i te wai
- whakahaere i te kōwhiri i te wai o te wai o te wai me ngā wai me ngā pūnaha taunaha.

Stormwater swale

Main pollutants

Heavy metals – lead, zinc, copper and cadmium washed into the system from roads. These are extremely toxic to both animals and plants.

Sediment – loose sand, clay, silt and erosion washed into the system from roads, building sites and driveways. These can increase stream temperatures and reduce the amount of food and oxygen for plants and aquatic life.

Oil and grease – fuels, motor oil, cooking oil, hydraulic oil, run from the road, and discarding of liquids that can't dissolve in water and are toxic to the ecosystem.

Nutrients – nitrogen and phosphorus run off from fertilisers and pet and garden waste. Small amounts aid in plant growth, but high levels can result in toxic algae blooms known as blue-green algae.

Stay safe around water
Water may contain bacteria or algal blooms that are commonly found in stormwater systems and can make people and animals sick.

- Avoid contact with water**
- Don't drink water**
- Do not eat fish from this stormwater system**
- Prevent animals or livestock from entering water**
- No recreational activities**

For more information visit
hamilton.govt.nz/water

WETLANDS INFORMATION SIGN BOARD

D4.27

Version: MAY 2018

REGIONAL INFRASTRUCTURE TECHNICAL SPECIFICATION

Drawing 4-34: Wetlands information sign board

5 WASTEWATER

5.1	Introduction.....	413
5.1.1	Objectives.....	413
5.1.2	Reference Documents.....	413
5.1.3	Level of Service.....	414
5.1.4	Areas not Serviced by Public Wastewater Systems.....	415
5.1.5	Alteration to Existing Infrastructure.....	415
5.1.6	Planning Documents and Assessments.....	415
5.2	Design.....	415
5.2.1	Design life.....	415
5.2.2	Acceptable Products.....	416
5.2.3	Catchment Design.....	416
5.2.4	Design Criteria.....	416
5.2.5	System Layout.....	422
5.2.6	Venting and Odour Control.....	424
5.2.7	Manholes.....	424
5.2.8	Connections.....	427
5.2.9	Building Over or Adjacent to Pipelines.....	429
5.2.10	Pump Stations.....	431
5.3	Construction.....	441
5.3.1	Pipeline Construction.....	441
5.3.2	Trenchless Construction.....	443
5.3.3	Joints.....	443
5.3.4	Manholes.....	444
5.3.5	Connections.....	445
5.3.6	Backfilling and Reinstatement.....	445
5.3.7	Pump Stations.....	446
5.3.8	Testing and Inspections for Pipelines.....	450
5.3.9	CCTV Inspections.....	452
5.3.10	Pump Station Commissioning.....	453
5.3.11	As-built Information.....	457
5.3.12	PLC Programme.....	466
5.3.13	Wiring Trace:.....	467
5.3.14	Level Monitoring Systems.....	469
5.3.15	Level Control Checks.....	470
5.3.16	Analogue Monitoring Performance Checks.....	471
5.3.17	Float Installation Check.....	472
5.3.18	MiniCas Supervision Relay Check.....	473
5.3.19	Pump Information Sheet.....	474
5.3.20	Pump Performance Checks.....	475
5.3.21	Pump Rotation Test.....	476
5.3.22	Pump Current Draw.....	477
5.3.23	Pump Riser Tests.....	477

5.3.24	Setting Pump Overload	477
5.3.25	Pump Pressure Head Measurement	477

LIST OF APPENDICES

No list of appendices found.

LIST OF TABLES

Table 5-1: Reference documents	413
Table 5-2: Wastewater Peaking Factors	417
Table 5-3: Population Equivalent	419
Table 5-4: Guide to Roughness Coefficients for Gravity Wastewater Lines.....	420
Table 5-5: Minimum Gradients for Self-Cleaning.....	420
Table 5-6: Minimum Gradients for Self-Cleaning – Small Developments	421
Table 5-7: Pipe Locations	422
Table 5-8: Minimum Clearance from Structures	423
Table 5-9: Minimum Pipe Sizes for Lateral Connections	428
Table 5-10: Control/Alarm Settings	438
Table 5-11: Criterion for Pump Selection	439
Table 5-12: Manhole leakage test - hold test time.....	451
Table 5-13: Pump Station Test Schedule.....	453
Table 5-14 : Pump Tests.....	454
Table 5-15 : Telemetry Connection and Electrical Cabinet Commission Test Schedule.....	455
Table 5-16 : Forms and Checklist Register	459
Table 5-17 : Drawing Register	479

LIST OF FIGURES

Figure 1-1:Acceptance process	21
Figure 1-2: Standard symbols	43

LIST OF DRAWINGS

Drawing 5-1: DN1050 - DN1350 manholes	480
Drawing 5-2: Typical dimensions for manholes greater than DN1350	481
Drawing 5-3: Shallow manhole/chamber.....	482
Drawing 5-4: Lateral connection	483
Drawing 5-5: Anti-scour blocks for steep drainage pipes.....	484
Drawing 5-6: Building over and adjacent to public wastewater or stormwater pipelines	485
Drawing 5-7: Wastewater pumping station stie plan layout	486
Drawing 5-8: Wastewater pumping station cross section	487
Drawing 5-9: Standard wastewater pumping station for Flygt 3085, 3102 and 3127 pumps.....	488
Drawing 5-10: Wastewater pump station upper section reinforcing.....	489
Drawing 5-11: Wastewater pump station lid frame	490

Drawing 5-12: Wastewater pump station lid frame detail.....	491
Drawing 5-13: Wastewater pump station lid frame detail.....	492
Drawing 5-14: Wastewater pump station lid details.....	493
Drawing 5-15: Wet well secondary lids.....	494
Drawing 5-16: Wastewater pump station storage plan.....	495
Drawing 5-17: Wastewater pump station storage section.....	496
Drawing 5-18: Wastewater pump station storage end elevation and details.....	497
Drawing 5-19: Control cabinet plinth and SPS flow meter.....	498
Drawing 5-20: Wastewater pump station backflow.....	499
Drawing 5-21: Wastewater pump station prevention cage.....	500
Drawing 5-22: Wastewater connections layout.....	501

LIST OF EQUATIONS

Equation 5-1: Average daily flow (ADF).....	417
Equation 5-2: Peak daily flow (PDF).....	417
Equation 5-3: Peak wet weather flow (PWWF).....	417
Equation 5-4: Pump station.....	432

5.1 INTRODUCTION

This section sets out requirements for the design and construction of wastewater systems for land development and subdivision.

The section is generally limited to the standards required for conventional reticulation systems. Alternative systems such as Effluent Drainage Systems (EDS), Modified Conventional Sewerage Systems (MCS), Low Pressure Sewer (LPS) and vacuum systems shall be subject to specific acceptance by Council and agreement on design standards.

5.1.1 Objectives

To provide an environmentally sustainable wastewater system, which produces no objectionable odour, does not overflow or adversely affect receiving waters, and is affordable while meeting the Regional Council discharge rules and consents, as well as meets Council’s levels of service.

The design of the wastewater system shall ensure an acceptable wastewater service for each property by providing a:

- a) Wastewater main laid generally within the Road reserve and at a level that will allow a gravity connection by a private line laid in accordance with the Building Act.
- b) Service connection from the main to each property.

Designers shall consider the hydraulic adequacy of the network including the specified levels of service, the ultimate service area of the system and impact on the existing network.

The wastewater system shall meet the minimum design life requirement taking into account structural strength, design loadings, soil conditions and wastewater conditions (internal and external corrosion). The system shall be designed to minimise the potential for water ingress and egress through the use of good design practise and new technologies.

The wastewater network shall be cost efficient over its design life while accounting for environmental and community impacts through integrated three waters management and water reuse.

5.1.2 Reference Documents

Details of documents referenced in this Section are as follows:

Table 5-1: Reference documents

AS 2200 : 2006	Design Charts for Water Supply and Sewerage
AS 3996:2006	Access Covers and Grates
AS 1579:2001	Arc-welded steel pipes and fittings for water and wastewater
AS 1741:1991	Vitrified clay pipes and fittings with flexible joints – sewer quality
AS/NZS 1260:2009	PVC-U pipes and fittings for drain, waste and vent applications
AS/NZS 1546:2008	On-site domestic wastewater treatment units (Part 1:2008 Septic tanks)
AS/NZS 2032:2006	Installation of PVC pipe systems
AS/NZS 2033:2008	Installation of polyethylene pipe systems

AS/NZS 2280:2014	Ductile iron pipes and fittings
AS/NZS 2566 Parts 1 and 2	Buried Flexible Pipeline – Structural Design & Installation
AS/NZS 2980:2007	Qualification of Welders for Fusion Welding of Steels
AS/NZS 3725:2007	Design for Installation of Buried Concrete Pipes
AS/NZS 4058:200	Precast concrete pipes (pressure and non-pressure)
AS/NZS 4129:2008	Fittings for polyethylene (PE) pipes for pressure applications
AS/NZS 4130:2009	Polyethylene (PE) pipes for pressure applications
AS/NZS 4671:2001	Steel Reinforcing Materials
AS/NZS 5065:2005	Polyethylene and polypropylene pipes and fittings for drainage and sewerage applications
NZS 3114:1987	Specification for Concrete Surface Finishes
NZS 4404:2010	Land Development and Subdivision Infrastructure
NZS 4442:1988	Welded steel pipes and fittings for water, sewage and medium pressure gas
NZS 7643:1979	Code of practice for the installation on unplasticised PVC pipe systems
Building Act 2004	
ISO 13953:2001	Polyethylene Pipes and Fittings – Determination of the Tensile Strength and failure mode of test pieces from a butt-fused joint
Lamont	Metrication: Hydraulic data and formulae (available from Iplex Pipelines)
Lars-Eric Janson	Plastic pipes for water supply and sewage disposal (2003)
Local Government Act 1974	Section 451
NZTA	SP/M/022 Bridge Manual
PVC Pipe Association (Uni-Bell)	Handbook of PVC pipe Design and Construction
Trade Waste Bylaw	As relevant to each council
Waikato Regional Council	Waikato Regional Plan, Section 3.5.7 : Implementation Methods – On-site Sewerage Discharges
Waikato Regional Council	Best Practice Guidelines for Waterway Crossings
Water New Zealand	NZ Pipe Inspection Manual 3rd Edition
Water Services Association of Australia	WSA 02:1999 (Table 2.4) WSA 02:2002 : WSAA Sewerage Code of Australia WSA 02:2014 : Gravity Sewerage Code of Australia Version 3.1;

5.1.3 Level of Service

The design of the system shall be such that a wastewater connection can be provided for each lot.

New wastewater systems shall achieve the following minimum standards:

- a) Pipelines shall not surcharge at the peak design wet weather flow.
- b) The system shall not be designed to overflow under normal conditions.

- c) Pumping station emergency storage shall not be used for flow buffering purposes.
- d) The system shall be designed with self-cleaning velocities.

Where the existing network is affected by the development, system upgrades shall meet the following minimum standards (which may need to be assessed in the council's wastewater model):

- Existing and predicted overflows shall not be made worse (volume or frequency). If this is likely to occur, Council will develop a project to address the overflows.
- Council may consider storage as a solution to manage existing capacity constraints..

5.1.4 Areas not Serviced by Public Wastewater Systems

Areas not served by a Council owned and operated public wastewater system shall comply with the Waikato Regional Plan, Section 3.5.7 Implementation Methods – On-site Sewerage Discharges.

5.1.5 Alteration to Existing Infrastructure

Alteration of the existing wastewater network to achieve the required level of service may be subject to a Development Agreement regarding costs.

Existing private pipework will only be acceptable for vesting to Council if it can be shown that both the materials and construction methodologies meet the requirements of this specification. A CCTV internal inspection and report in accordance with the NZ Pipe Inspection Manual will be required. For networks serving more than two properties a Net Present Value calculation and cash contribution may be required prior to vesting.

5.1.6 Planning Documents and Assessments

All design shall be undertaken in accordance with the relevant District Plan, bylaws, policies and this Infrastructure Technical Specification.

Where relevant documents exist, such as an Integrated Catchment Management Plan; a Water Impact Assessment; a Wastewater Network Master Plan, an Infrastructure Plan or an Asset Management Plan, the planning and design of the wastewater network shall be in accordance with the principles and requirements contained within the document(s).

Council will advise developers of the existence of any relevant documents during initial discussions regarding development. Design shall not occur until the requirements have been confirmed.

The relevant documents may contain details of strategic infrastructure to be located within the development area. The responsibility for the design and construction of strategic infrastructure shall be agreed with Council prior to commencing design.

5.2 DESIGN

5.2.1 Design life

Wastewater systems shall be designed and constructed for an asset life of at least 100 years. Specific components such as pumps, valves, and control equipment may require

earlier renovation or replacement but shall meet the life expectancies as set out in Council's Asset Management Plan.

5.2.2 Acceptable Productsals

Refer to the [Acceptable Products Section 8](#).

Materials and grades for gravity pipelines greater than DN375 shall be determined by specific design and in consultation with Council. Rising mains shall be specifically designed based on the characteristics of the pumped system being serviced.

Where a trade waste discharge is known material selection shall be specific to the nature of the discharge.

5.2.3 Catchment Design

The system shall be designed to serve the whole of the natural (gravity) catchment area. The design flow shall be calculated from all of the upstream catchment falling within the relevant council's zoning boundary. The calculation shall assume complete urbanisation (excluding reserves). Refer Table 5-2.

Council strategic planning may require an adjacent catchment to be serviced via another. Where this is required it will be stipulated in an Integrated Catchment Management Plan or Master Plan where one exists, or it will otherwise be identified by Council.

Pipes shall be designed to service the entire catchment area and any future extension of the system. This may affect the pipe location, diameter, depth, and classifications such as trunk mains. Designers shall adopt best practice to ensure a system with lowest whole of life cost.

5.2.3.1 Extent of Infrastructure

Where pipes are to be extended in the future, the ends of pipes shall extend past the boundary of the development by a distance equivalent to the depth to invert and be capped off. This ensures that future extension of the pipe does not require unnecessary excavation within lots or streetscapes which are already developed. Easements may be required over the pipe in the adjacent property.

5.2.4 Design Criteria

5.2.4.1 General

Wastewater flows are a function of water consumption, infiltration and direct ingress of stormwater.

All wastewater pipelines shall be designed such that they have sufficient capacity to cater for the design wet weather flow from the area they serve without surcharge and that on at least one occasion every day a minimum velocity for solids re-suspension (self-cleaning) is achieved.

5.2.4.2 Calculation of Flows

The wastewater flows shall be calculated from the following design parameters:

- Domestic Average Daily Flow (ADF) is 200 litres per person per day
- Infiltration allowance is 2250 litres per hectare per day
- Surface water ingress is 16500 litres per hectare per day
- Peaking Factors as per Table 5-2.
- Population Equivalent as per Table 5-3.
- Gross contributing land area upstream (see Clause 5.2.3) of the wastewater pipe is defined as the total catchment area, excluding reserve land, but including land within legal road boundaries

Contact Council for advice regarding the extent (both present and future) of any upstream catchment boundaries if an Integrated Catchment Management Plan does not exist.

Average Daily Flow (ADF)

The Average Daily Flow is calculated as the sum of the infiltration allowance and the daily wastewater flow:

Equation 5-1: Average daily flow (ADF)

$$ADF (m^3/day) = (infiltration\ allowance \times catchment\ area) + (water\ consumption \times population\ equivalent)$$

Peak Daily Flow (PDF)

The system shall achieve a daily self-cleaning velocity the Peak Daily Flow.

Equation 5-2: Peak daily flow (PDF)

$$PDF (L/sec) = ((infiltration\ allowance \times catchment\ area) + (peaking\ factor \times water\ consumption \times population\ equivalent)) \div 86400$$

Peak Wet Weather Flow (PWWF)

The system shall accommodate the design Peak Wet Weather Flow without surcharge.

Equation 5-3: Peak wet weather flow (PWWF)

$$PWWF (L/sec) = ((infiltration\ allowance \times catchment\ area) + (surface\ water\ ingress \times catchment\ area) + (peaking\ factor \times water\ consumption \times population\ equivalent)) \div 86400$$

Table 5-2: Wastewater Peaking Factors

POPULATION EQUIVALENT FOR CATCHMENT OR SUB CATCHMENT AREA	WASTEWATER PEAKING FACTORS	
	RESIDENTIAL	COMMERCIAL
10	14	13
15	12	11
20	10	9.5
25	9.1	8.5
30	8.5	8.0

POPULATION EQUIVALENT FOR CATCHMENT OR SUB CATCHMENT AREA	WASTEWATER PEAKING FACTORS	
	RESIDENTIAL	COMMERCIAL
35	8.0	7.5
40	7.5	7.2
45	7.0	6.9
50	6.8	6.3
55	6.7	6.0
60	6.3	5.7
65	6.2	5.5
70	6.0	5.4
75	5.9	5.3
80	5.8	5.1
90	5.5	5.0
100	5.3	4.8
125	5.0	4.2
150	4.8	4.0
175	4.4	3.8
200	4.1	3.7
250	4.0	3.5
300	3.8	3.3
350	3.7	3.1
400	3.5	3.0
450	3.4	2.9
500	3.3	2.8
600	3.2	2.7
700	3.2	2.6
800	3.1	2.55
900	3.0	2.5
1000	3.0	2.4
1500	2.9	2.2

POPULATION EQUIVALENT FOR CATCHMENT OR SUB CATCHMENT AREA	WASTEWATER PEAKING FACTORS	
	RESIDENTIAL	COMMERCIAL
2000	2.8	2.1
2500	2.8	2.0
3000	2.7	1.9
3500	2.6	1.85

The following equivalent population densities per hectare shall be adopted in the absence of specific supportable design data.

Table 5-3: Population Equivalent

AREA	POPULATION EQUIVALENT
General Residential, Medium Density Residential, Temple View, Special Heritage, Special Residential Zones	45 persons per hectare, or not less than 2.7 persons per dwelling
Residential Intensification Zone	120 persons per hectare
All Business Zones, Community Facilities Zone	30 persons per hectare
All Industrial Zones, City Centre Zone, Major Facilities Zone	45 persons per hectare
Future Urban Zones	45 persons per hectare
Other establishments should be treated as follows:	
Primary Schools	45 persons per hectare
Secondary Schools	150 persons per hectare
Hospitals	3.5 persons/bed
Motels	0.6 persons/bed

Assessment criteria to determine flows from any development, or re-development, not covered in this section shall be determined in conjunction with Council.

5.2.4.3 Commercial and Industrial Flows

Where the industrial domestic waste and trade waste flows from a particular industry are known, these shall be used as the basis of the wastewater design. Where this information is not available, flows shall be calculated using the relevant peaking and population densities defined in Table 5-3.

When known, provision for liquid trade waste and ‘wet’ industries shall be considered and provided for by the design.

Notwithstanding the above, provision for trade waste shall be made by arrangement with the Council and shall be subject to the provisions of the Trade Waste Bylaw.

5.2.4.4 Hydraulic Design

The hydraulic design of pipelines should be based on the Colebrook-White formula. The coefficients to be applied are as per Table 5-4. Minimum grades and maximum velocities are provided in Sections 5.2.4.5 and 5.2.4.7 respectively.

Table 5-4: Guide to Roughness Coefficients for Gravity Wastewater Lines

MATERIAL	COLEBROOK-WHITE COEFFICIENT K (MM)
PVC	0.6
PE	0.6
GRP	0.6
Cement Lining	1.5
PE or epoxy lining	0.6

Note:

- a) *These values take into account possible effects of rubber ring joints, slime, and debris*
- b) *The k values apply for pipes up to DN 300*
- c) *For further guidance refer to WSA 02:1999 table 2.4; AS 2200 table 2; Plastics pipes for water supply and sewage disposal (Janson), Metrication: Hydraulic data and formulae (Lamont), or the Handbook of PVC pipe (Uni-Bell)*

5.2.4.5 Minimum Grades for Self-Cleaning

Self-cleaning of grit and debris shall be achieved by providing minimum grades, as specified in Table 5-5 and Table 5-6.

Table 5-5: Minimum Gradients for Self-Cleaning

PIPE SIZE DN (MM)	MINIMUM GRADE (%)
Reticulation	
150	0.55
225	0.33
Lateral Connections	
100	1.65
150	1.2
Permanent Upstream Ends	
100	1.0
150	1.0

Table 5-6: Minimum Gradients for Self-Cleaning – Small Developments

HOUSES	POPULATION	GENERAL MINIMUM GRADE	PEAT SOIL GRADES
3-4*	7-10	1:100	1.0%
5-8	12-20	1:120	0.83%
9-18	22-45	1:150	0.67%
More than 18	45 and above	1:180	0.55%

*see also the guidelines for service connections Section 5.2.8

5.2.4.6 Step Grades

Where the pipeline gradients are greater than 1 in 5, anchor and/or anti-scour blocks shall be constructed of a type comparable to that illustrated in [Drawing D5.5](#).

Note: on gradients flatter than above where scour is a problem, sand bags or similar are to be used to stabilize the trench backfill.

5.2.4.7 Maximum and Minimum Velocity

The preferred maximum velocity for peak wet weather flow is 3.0m/s. Where a steep grade that will cause a velocity greater than 3.0m/s is unavoidable refer to the Water Services Association of Australia: Sewerage Code of Australia: WSA 02-002 for precautions and design procedures.

The minimum velocity for self-cleaning at peak daily flow will be deemed to be 0.6m/s.

5.2.4.8 Piped Reticulation System Minimum Requirements

- a) Irrespective of other requirements, the minimum pipe size for a public gravity wastewater pipe shall be not less than 150DN and a lateral connection not less than 100DN
- b) In no circumstances shall the pipe size be reduced on any downstream section

5.2.4.9 Structural Design for installation of buried pipes

AS/NZS Standards provide methods and data for calculating the working loads on buried pipes due to:

- a) The materials covering the pipes
- b) Superimposed loads

PE and PVC Pipes

AS/NZS 2566 Part 1 (including the commentary) and Part 2 provides the method to assess the pipe selection and embedment method of buried flexible pipelines. This standard is also applicable to other materials listed in the Table included in section 1.2 APPLICATION of the AS/NZS Standard.

Definitions:

Embedment – the material surrounding the pipe and which is composed of the following zones:

- a) Bedding – the zone between the foundation and the bottom of the pipe
- b) Haunch support – the part of the side support below the spring line of the pipe
- c) Side support – the zone between the bottom and top of the pipe
- d) Overlay – the zone between the side support and either the trench fill or embankment fill

Fill – One or more of the following:

- a) Embankment fill – fill material placed over the overlay for the purpose of creating an embankment
- b) Trench fill – fill material placed over the overlay for the purpose of refilling a trench
- c) Foundation – a naturally occurring or replacement material beneath the bedding

5.2.5 System Layout

The preferred layout/location of pipes is as follows:

Table 5-7: Pipe Locations

Area	Location
Residential	Within the Transportation Corridor normally 2m out from the kerb except where the properties served are below road level. Manholes should be located wherever possible in the centre of the moving lane (outside the wheel tracks).
Industrial	Within the Transportation Corridor normally 2m out from the kerb alternatively in the front yard area with approval.
Business	Within the Transportation Corridor normally 2m out from the kerb or alternatively in the rear service lane with approval. The major reticulation and trunk lines, however, shall be in the Transportation Corridor (as for Residential Zones).
Other Areas	Within the Transportation Corridor except where the properties served are below road level.
Private Property	If no other option is available, pipelines may be laid within private property. Where a pipeline is within a property, it is required to be parallel to, and no closer than 1.5m from, a boundary. No new private drains shall pass between one lot and another. If crossing of private property is unavoidable, those parts of the pipeline serving more than one lot shall be Council mains with service connections to the property boundaries or protected by public or private easement. The public easement width shall be based on the 45° zone of influence centred on the pipe, and be a minimum of 1.5m. The major reticulation and trunk lines however shall be in the Transportation Corridor.

Where a wastewater pipeline changes location within a street, crossings of roads, railway lines, and underground services shall, as far as practicable, cross at an angle of 45 degrees or greater. Pipes shall be located and designed to minimise maintenance and crossing restoration.

5.2.5.1 Topographical considerations

In steep terrain the location of pipes is governed by topography. The pipe layout shall conform to natural fall as far as possible to remove the need for gravity pipelines operating against natural fall and thus creating the need for deep pipes.

5.2.5.2 Aerial Pipes and Pipe Bridges

- a) Aerial pipes, inverted syphons, and pipe bridges are discouraged
- b) Before adopting the use of aerial pipework and pipe bridges alternative routes and solutions shall be investigated
- c) Benefit cost analysis shall be completed for all proposals and whole life costs including future maintenance shall be provided. Benefit cost analysis shall be completed for all alternative designs for comparison purposes

5.2.5.3 Minimum/Maximum Cover

All pipelines, other than those in private property, shall be specifically designed to support the likely loading in relation to the minimum cover to be provided in accordance with the terms of AS/NZS 3725. The minimum cover for all types of pipes under all conditions shall be 600mm.

For private pipelines in private property the depth of cover is dealt with under the Building Act 2004 and approved by the Council’s building section.

5.2.5.4 Clearances from Underground Services

Clearance from underground services shall be as per NZS 4404 Section 5.3.7.9.

5.2.5.5 Clearance from Structures

Pipes adjacent to existing buildings and structures shall be located clear of the ‘zone of influence’ of the building foundations. Refer [Drawing D5.6](#). If this is not possible, a specific design shall be undertaken to cover the following.

- Protection of the pipeline
- Long term maintenance access for the pipeline
- Protection of the existing structure or building

The protection shall be specified by the Developer for evaluation and acceptance by Council.

Sufficient clearance for laying and access for maintenance is also required. Table 4-13 may be used as a guide for minimum clearances for mains laid in public streets. See [Drawing D5.6](#).

Table 5-8: Minimum Clearance from Structures

PIPE DIAMETER DN (MM)	CLEARANCE TO WALL OR BUILDING (MM)
<100	600
100 – 150	1000
200 – 300	1500

PIPE DIAMETER DN (MM)	CLEARANCE TO WALL OR BUILDING (MM)
375 +	1500 + 2 x diameter

NOTE – These clearances should be increased by 500mm for mains in private property as access is often more difficult and damage risk is greater.

5.2.6 Venting and Odour Control

Situations where venting may be required include:

- At pumping stations
- At manholes where pumping stations discharge to a gravity pipe. Refer [Drawing D5.9](#)

A specific engineering design shall be submitted to Council for acceptance where pressure wastewater lines are likely to discharge odours because of changes in hydraulic conditions and/or for aged sewage.

5.2.7 Manholes

Manholes are to be located:

- On Council property or Transportation Corridors whenever possible and if within the carriageway, they shall be 2m out from the kerb but clear of wheel tracks (to minimise noise and vehicle user discomfort)
- Out of hollows, dips or any area that may be subjected to inundation or identified as a secondary flow path
- Clear of all boundary lines by at least 1.5m from the outer edge of the manhole chamber plus the height of any nearby retaining walls if applicable
- 2.0m clear of new structures in private property as shown in [Drawing D5.6](#).

Manholes are required at the following locations.

- Intersection of pipes except for junctions between mains and lateral connections
- Changes of pipe size
- Changes of pipe direction, except where horizontal curves are permitted
- Changes of pipe grade, except where vertical curves are permitted
- Combined changes of pipe direction and grade, except where compound curves are permitted
- Changes of pipe invert level
- Changes of pipe material, except for repair/maintenance locations
- Permanent ends of the public pipe where a maintenance shaft (MS) is not possible
- Discharge of a pressure main (public or private pump) into a gravity pipe

For infill developments, manholes shall not be required for a 150mm connection on a 150mm pipeline where a manhole is provided immediately inside the property being

served and another manhole exists within 100m on the existing pipe as these provide adequate accessibility without needing another manhole.

5.2.7.1 **Distance between Manholes**

For reticulation pipes, the maximum distance between any two manholes shall be 120m.

5.2.7.2 **Size of Manholes**

Manholes shall be a minimum of 1050mm diameter for depths of 1.0m or more.

Manholes of 750mm diameter are permitted to be used for depths less than 1.0m at the upstream end of public sewers.

5.2.7.3 **Manhole Materials and Parameters**

All Manholes shall be pre-cast concrete with an external flange base.

Manholes up to 2400mm deep (excluding the top and manhole lid) shall be constructed using a single riser with a pre-cast external flange base. Manholes in excess of 2400mm deep shall be constructed using a 2400mm deep pre-cast riser with external flange base and then completed to final ground level using no more than a single riser for manholes up to 5.0m deep. Three risers are allowable for manholes in excess of 5.0m depth.

In no case shall a series of short risers be permitted.

The joints of all abutting units shall be sealed against ingress of water by the use of BM100 (Humes' Sealing Strip or Hynd's Grey Butyl Manhole sealant or an accepted equivalent).

The cover frame shall be set over the opening and adjusted to the correct height and slope using adjustment rings and mortar so as to conform to the surrounding surface (refer to Drawings [D5.1](#) – D5.3). The cover frame shall be held in place with a bold fillet of concrete.

5.2.7.4 **Manholes Requiring Specific Design**

Where manholes are more than 5.0m deep they shall be specifically designed in accordance with the manufacture's requirements for external pressures and resist floatation.

Where a manhole is to be constructed in soft ground, the area under the manhole shall be undercut to provide an adequate foundation and backfilled with suitable hard fill for the manhole base. Where undercutting exceeds 1.5m, a special design will be required.

5.2.7.5 **Flotation**

In areas of high water table, all manholes shall be designed to provide a factor of safety against flotation of 1.25.

5.2.7.6 Allowable Horizontal Deflection through Manholes

A maximum allowable deflection through a 1050mm diameter manhole for pipe sizes 150 to 225DN is up to 90 degrees. The maximum allowable deflection for pipe sizes greater than DN225 is 110 degrees.

5.2.7.7 Connections to Manholes

- a) The invert of a connection must connect to the channel in the manhole at a level no lower than the average of the soffit levels of the main inlet and outlet pipes
- b) Maximum angle of deflection of lateral connection into the manhole main channel shall be 90 degrees
- c) Drop connections at manholes shall be designed in a manner similar to the illustrations in Drawings [D5.1](#) and [D5.3](#). Only two internal drop connections per manhole.
- d) Internal drops shall only be accepted where existing manhole diameters are 1200mm or greater

5.2.7.8 Internal fall through Manholes

In addition to the normal pipeline gradient, all manholes shall have a minimum drop of 20mm plus 5mm per 10 degrees of the angle of change of flow within the manhole.

The construction tolerance for drop through the manhole shall be:

$$\text{Constructed Manhole Drop} = \text{Manhole Drop (as calculated above)} \pm 5 \text{ mm}$$

Grading the channel shall be limited to falls through manholes of up to 150mm.

To avoid excessively steep channels within manholes, steep grades shall be 'graded-out' at the design phase where practicable.

Channel half pipe liners shall be used and match the diameter of the downstream pipe with a tolerance of + 5mm, - 0mm.

5.2.7.9 Covers

Watertight manhole covers with a minimum clear opening of 600mm in diameter, complying with AS 3996, shall be used. Refer to [Acceptable Products Section 8](#).

- a) 'Non-rock' covers must be used on all State Highway and Level 2 roads (with greater than 10,000 vehicles per day).
- b) 'Heavy Duty' covers must be used in the Transportation Corridor, carriageway, commercial and industrial properties and all public areas.
- c) 'Standard' covers may only be used in residential properties.

5.2.7.10 Manhole Steps

All manholes shall be provided with steps in order to provide access. These shall be of the 'dropper' or 'safety' type to prevent feet sliding sideways off them.

Manhole steps shall be provided at 300mm centres vertically (refer [Drawings D5.1](#) and [D5.2](#)). The top step shall not be more than 450mm below the top of the top slab, and the lowest step shall be not more than 375mm above the bench, or such lower level if detailed on other than standard manholes. The manhole steps shall be located over the downstream pipe.

5.2.8 Connections

5.2.8.1 General

Before dwellings are connected to the public wastewater system, the Council connection process and forms [F5.1](#) to F5.6 shall be completed by the applicant and accepted by Council. This applies to:

- a) All new connections and disconnections from private property
- b) All new connections of new wastewater mains to be teed into the existing public wastewater system
- c) For all connections where trade waste will be discharged, compliance with the Trade Waste Bylaw is required.

The lateral connection should be designed to suit the existing situation and any future development. The lateral will be positioned so that the private section of the connection with each lot can be constructed in accordance with the Building Act. This is generally at the lowest location in the lot.

Refer to [Drawing D5.22](#) for connection layouts

Where the Council's Wastewater Bylaw differs from this specification, it shall take precedence over the point of discharge as shown in the drawing.

5.2.8.2 Requirement of Design

The following design requirements shall be met.

Irrespective of other requirements, the minimum sizes of lateral connection and reticulation pipes shall be not less than those shown in.

- a) Table 5-9: Minimum Pipe Sizes for Lateral Connections
- b) Each connection shall be capable of serving the building platform by gravity. This requirement shall allow adequately graded drains within the lot, together with the depth required for gully traps. Private wastewater pumps will not be approved where gravity discharge is feasible.
- c) The standard depth of a new connection at the boundary is 1.2m (range 0.9 - 1.5m). Refer [Drawing D5.4](#).
- d) Where practicable and where the connection to be installed is to be within 5.0m of a manhole the connection shall be to the manhole.
- e) All connections, which are to be made directly to the line, shall be designed using a factory manufactured 'wye' or 'London Junction' and shall be watertight

- f) Service connections shall generally enter each lot from the road frontage. Where a property has no road frontage, pipes shall be located within that property's legal access (right of way or access strip).
- g) Private pipes shall not cross property boundaries but where this is not feasible, the developer shall provide an appropriate drainage easement.

Table 5-9: Minimum Pipe Sizes for Lateral Connections

PIPE	MINIMUM SIZE DN (MM)
Connection servicing up to four dwelling units	100
Connection servicing more than four dwelling units	150
Connection servicing commercial and industrial lots	150

Sections which slope away from the drainage direction may require a service connection which is deeper than 1.5m at the boundary in order to comply with the requirement to drain the whole of the lot. In such cases the service pipe shall be extended into the property on grade and to the extent that it's end cap is no deeper than 1.5m.

5.2.8.3 Services in Access Ways, Access Lots, or Rights of Ways

The following should be considered when preparing design.

- a) Where a right-of-way is to be provided, wastewater services for all newly created lots should drain to the right-of-way where possible
- b) Where the existing lot does not have direct access to the public wastewater after subdivision, the connection which runs through the newly created lot shall be designed and constructed as per this specification and vested in Council to allow for normal operations, maintenance, renewals and prevent building over

5.2.8.4 Multi-Unit Properties

For multiple occupancies (unit title, cross lease or company lease), service of the whole development shall be achieved by providing a single point of connection to the wastewater system. Connection of the individual units is by joint service pipes owned and maintained by the body corporate, tenants in common or the company as the case may require. Private drainage is to be approved and constructed as per the Building Act / Code.

5.2.8.5 Ramped Risers

Unless required otherwise by Council, a ramped riser shall be constructed to bring the connection to within 0.9m - 1.5m of ground level, or to such depth that will permit a gravity connection to service the whole lot. Ramped risers shall be constructed as shown in [Drawing D5.4](#).

5.2.8.6 Connection to Trunk and Interceptor Pipelines

Connections to wastewater trunk pipelines shall be at manholes, or alternatively, and only with specific acceptance by Council, utilising factory fabricated 'wye' junctions in pipelines of PVC or vitrified clay materials.

A reticulated pipe connection to a wastewater interceptor shall only be designed in conjunction with the Council.

Note: No individual lot connections are permitted into an interceptor.

5.2.8.7 Connections to Deep Lines

Where an existing or proposed wastewater pipe is more than 5.0m deep (to the top of the pipe), or where required by the ground conditions, a manhole will need to be constructed on the shallower line. This should be 5m from the deep line and ramped down to it.

5.2.9 Building Over or Adjacent to Pipelines

Building close to or over pipelines is generally discouraged as this practice severely limits Council's ability to either maintain or duplicate the pipeline if required in the future.

Council does not permit building over or within the specified distances of the following infrastructure (refer [Drawing D5.6](#)):

- Wastewater rising mains and interceptors – 5 metres
- Pump stations and associated infrastructure – 5 metres
- Connections – 2 metres
- Manholes – 2 metres

The pipe must be located on site so this assessment can be made. Alternative options such as relocating the proposed building, or decommissioning of/or diverting the pipeline along property boundaries, shall be thoroughly investigated by the developer before building over a pipeline will be permitted.

In order of preference pipes shall either be:

- a) removed (where practical) and connections relocated, dependent on usage capacity for the pipe, at a cost to the development (Refer to Section 451 of Local Government Act 1974)
- b) relocated to avoid the construction, and at a cost to the development (s451 of LGA 1974)
- c) replaced on present alignment, extending from boundary to boundary (or manhole as appropriate) at a cost to the development (s451 of LGA 1974)

The Developer/Applicant will be responsible for all costs associated with:

- Investigation and design associated with seeking acceptance;
- Construction, if acceptance is granted;
- Repairing any damage identified to a sewer main or associated sewer infrastructure caused by construction over or near an existing sewer;
- The creation or relocation of easements.

5.2.9.1 Inspection

Any application to build over or within 5m of an existing public sewer must include the following:

- A CCTV inspection of the subject sewer, in accordance with Section 2 of the New Zealand Pipe Inspection Manual, undertaken by a contractor qualified and with the necessary experience to do so, or by Council, at the applicant's expense.

- Where the CCTV inspection is undertaken by the Developer, prior approval from Council shall be obtained.
- The results of the CCTV inspection are to be submitted to Council with the application. The inspection may be used as a dilapidation survey.

Pre-inspections are required to confirm the location of the pipes traversing the entire development site, their condition and ensure connections are not built over.

Building or Engineering plans submitted to Council shall also incorporate the confirmed locations of the main, manholes and connections identified by the CCTV inspection as these factors may dictate the development layout/design.

Post inspections are required when any construction involves piling within the 45° influence envelope of the wastewater pipe to ensure no damage has occurred during installation of piles/foundations.

No further construction work can be carried out until results are known from the Post Inspection.

Should the CCTV inspection identify faults, then the council may require the developer to:

- Reconstruct the sewer main in its existing location using construction materials as specified by Council to approved plans; or
- Reline the existing sewer main by a suitably qualified contractor.

All works on gravity sewer mains must be completed for the full extent between manholes.

5.2.9.2 **Structural loads – building over**

No structural loads shall be placed on, or be transferred to the pipeline, or other assets. All structural loads shall be absorbed (by means of piles where appropriate) outside of the 45° influence envelope and below the invert level of the wastewater pipe for the first row of piles (refer [Drawing D5.6](#)).

The first row of piles shall be located at least 1.5m clear from the outside edge of the wastewater pipe and 2.0 m clear from the outside wall of any public manhole, and be founded at least 1.0m below invert level of pipe.

Subsequent pile rows shall be founded at least 1.0m below the 45° envelope of the influence line of the wastewater pipe at invert level.

5.2.9.3 **Building adjacent to**

Any building, structure (including retaining wall) or other development shall be designed and founded so that it will not be adversely affected by public infrastructure and associated trench line, including any future excavation that may be required for the maintenance of the infrastructure. The building, structure or other development shall make provision to allow for any future possible settlement of the public trench line and backfill and consequent reduction in lateral support. This is to ensure the public infrastructure will not be adversely affected. CCTV inspection of all wastewater and stormwater pipes is required before and after construction.

5.2.9.4 Pile Ramming

No pile ramming is permitted within 5m from the centreline of any public wastewater, or within the 45° envelope of the influence line of the wastewater pipe at invert level. Pile ramming shall include sheet piling.

These piles shall be drilled only.

5.2.9.5 Abandoned Mains

Pressure or gravity mains which have been abandoned may remain in the ground providing they are capped. Council may require certain abandoned mains to be backfilled with grout depending on size, material type and proximity to other structures which may be put at risk in the event of the main collapsing.

If the abandoned mains are required to be removed then the trench shall be backfilled and compacted to at least 98% standard compaction.

5.2.9.6 Excavating over Existing Pipes

Excavations over or adjacent to an existing sewer main are not to reduce the cover over the main to less than the minimum limits in accordance with the relevant AS/NZS standard. Where the cover is changed due to, for example new carriageways or fill, the existing pipe shall be protected or the pipe upgraded to take the additional load.

5.2.10 Pump Stations

Pump stations shall only be accepted if they are incorporated into an approved Integrated Catchment Management Plan. In an area where there is no approved Integrated Catchment Management Plan, specific approval to install a pump station is required from Council. Where topography does not permit gravity connection to the wastewater system, pump stations shall not be proposed for less than 25 lots unless approved by Council. Individual pump stations with individual connections (i.e. low pressure sewers) are preferred in these circumstances. These are subject to specific design. Where a combined rising main is the best option then the extent of public /private ownership is to be agreed with Council.

5.2.10.1 Minimum Requirements

Pump station design shall ensure that the following minimum requirements are met.

- a) Area around the pump station shall be graded to prevent surface water flowing onto or over the pump station cover slabs
- b) Free of secondary flow paths for 1% AEP flood level, and the pump station lid levels shall be provided with a minimum freeboard of 300mm above the estimated flood level
- c) Pumping systems shall
 - (i) Have a pumping capacity of N+1 with a minimum of two identical pedestal mounted submersible sewage pumps
 - (ii) Each pump shall be capable of discharging the design peak wet weather flow rate from the catchment
 - (iii) Include sufficient well volume to operate under normal conditions without surcharge to the incoming wastewater network

- d) The station shall be located to ensure that the entire design catchment can be serviced
- e) All stations shall be contained within a separate local purpose reserve - drainage title set out to provide safe and easy operation and maintenance of the site without impacting on public activities surrounding the site and is designated in accordance with the relevant District Plan or vested as part of a subdivision
- f) The station shall be designed to service the entire catchment area of land beyond the reach of the existing gravity system. Refer to clause 5.1.6.
- g) In staged construction, guidance from the Council is required to ensure the correct sizing of the pump station and associated rising mains and storage facilities meet the short and long term requirements of the catchment
- h) A minimum emergency storage capacity of nine hours average dry weather flow, measured between the High Level alarm & the point of overflow.
- i) It is recommended that prior to submission of the detailed design, consultation is undertaken with Council to ensure that the design is fit for purpose.

5.2.10.2 Pump Station Sizing

A pump station design will document the effluent volumes and associated pump requirements for the fully developed catchment and at commencement of operation.

The calculation of flow will follow the design specifications in Section 5.2.4.2.

These projections will be described as

- Average Daily Flow (ADF)
- Peak Wet Weather Flow (PWWF)
- Peak Daily Flow (PDF)

If the station catchment is to be fed by other pumping stations then these flows are to be calculated both for the direct gravity catchment as well as direct plus contributing catchment.

These projections will be used as the basis for sizing the various components with in the design:

Equation 5-4: Pump station

Wet well diameter = Peak Wet Weather Flow at 50 year projection

$$\phi = 2 \times \sqrt{\frac{\left(\frac{900 \times Q}{N}\right)}{\pi}} / d$$

Where:

- Q = Pumping Rate L/s
- N = 15 (maximum number of starts per hour)
- d = minimum operational depth @ 400mm

- \varnothing = Well diameter in mm
- The pump selection and physical clearance may necessitate the development of a wider wet well
- Storage = Peak Wet Weather Flow at 50 year projection for direct gravity catchment
- Pump Size = Peak Wet Weather Flow at 20 years projection with contributing catchment.
- Rising Main Diameter – shall be selected to achieve flow velocities of 1-3m/s. Rising mains shall ideally operate in the efficient range of 1.0 to 1.5m/s but may exceed this for the purposes of staging and future flows.

Where connection to an existing rising main is required, a full analysis of all combinations of pumps shall be carried out.

- All calculations shall be submitted to Council for approval, all assumptions, design variables etc., shall be clearly documented.

5.2.10.3 General Layout

The site shall be laid out such as to comply with [Drawing D5.7](#).

The alignment of the pump station shall be set out with reference to permanent land transfer pegs or temporary boundary marks, placed by the licensed cadastral surveyor responsible for the final land transfer pegging.

The site design will include a paved all weather access road, no narrower than 3.5m with the centre line of the parking space being no greater than 4.0m in plan from the pump chamber and no greater than a 0.5 m difference in elevation between the parking area and lid elevation.

Where the accessway has to be of a length greater than 30m, a turning point for a light commercial vehicle is to be provided at the well. The gradient of the access way shall not exceed 1 in 6 and all turning radii comply with light truck tracking curves.

The control cabinet shall be located with the switch gear facing the wet well and placed no closer than 2.5m to any well or valve chamber lids and no greater than 5.0m. This is to provide safe working room between an open lid and the cabinet.

The above ground structures, including but not limited to control cabinet, odour control and RPZ, shall be positioned such that any 'out of control' vehicles leaving surrounding public roadways are unlikely to damage these structures. Protection such as guardrail or posts and rails may be required.

An area of 5.0m x 5.0m shall be available to accommodate an odour biofilter, either at the time of construction or in the future.

5.2.10.4 Collection Manhole

Immediately upstream of the pump station and within the local purpose reserve a single manhole is to be provided with the purpose of the collection of all wastewater flows from the catchment. The collection manhole must be sited to allow ease of access for cleaning purposes.

The collection manhole is to be constructed with a sump to trap gravel, rocks and other solid objects and prevent them entering the pump station wet well. The manhole must be a minimum of 1200mm diameter and have a minimum sump depth of 500mm as measured from the invert of the outlet pipe.

The minimum volume of the collection manhole shall be five times the litre per second rate for peak wet weather flow.

5.2.10.5 **Pump Station Inlet Pipe**

Only one gravity pipe may discharge into the wet well and must include an isolation valve. Where multiple inflows occur they must discharge to a receiving manhole, then into the wet well.

5.2.10.6 **Wet well**

Diameter

The minimum diameter of the pump chamber will meet both the minimum separation distances of the pump supplier and provide sufficient operational capacity to meet the maximum number of starts per hour (refer Section 5.2.10.11) but be no less than 1.8m.

Depth

Sufficient depth shall be provided in the pump chamber such that

- The invert level of the gravity inlet pipe and emergency storage well shall be a minimum of 100mm above the standby pump start level to prevent surcharge of the system during normal operation.
- That the minimum distance between duty pump start and stops levels is 400mm.
- The design stop level is 50mm above the pump manufacturer's minimum continuous operating levels

Structural Stability

The pump station wet well shall be designed to have negative or zero buoyancy when the well is empty. Accordingly the chamber may require mass concrete in the bottom to counter buoyancy forces. The depth and extent of mass concrete shall be as specified on the engineering plans.

The ground water level shall be assumed to be at ground level unless an actual level is established by geotechnical investigation and accepted as suitable for this purpose by the Council.

The mass of the wet well structure included in the stability analysis shall not include the associated mechanical and electrical components of the pump station nor can the soil friction forces of backfill around the wet well chamber be taken into account. Any additional weight needed shall be added in the form of mass concrete in the bottom of the chamber as indicated in [Drawing D5.8](#). The proposed pump station drawings shall provide dimensions of the extent of mass concrete needed to counter buoyancy of the chamber.

Valve Chamber

The valve chamber shall be attached to the pumping chamber. Where the delivery point is within close proximity to the pumping station the valve chamber may be dispensed with and a separate rising main from each pump laid to the delivery point. Where this occurs provision in land allocation shall still occur to cater for any future operational changes.

The layout of the pumping chamber, valve chamber and pipe work shall be similar to that shown on [Drawing D5.9](#).

Lids

The lids shall be of a standard design as shown in [Drawing D5.15](#).

For any well or chamber where the depth is greater than 2.0m secondary lids are required for health and safety purposes.

5.2.10.7 Emergency Storage

Pump stations shall provide for wastewater storage in the event of pump failure through, electricity outage.

Sizing

A minimum 9 hours emergency storage based on Average Daily Flow (ADF) shall be provided prior to emergency overflow occurring. The storage volume should be measured between the high level alarm and the point of overflow.

The required storage volume shall be provided by:

- The volume of the wet well, plus
- Any additional ancillary storage chambers, plus
- The volume of pipelines (500 mm below overflow level) draining to the facility at time of commissioning

The wet well volume below the high level alarm level shall be excluded from the calculation of available storage volume.

Layout

A typical storage layout is provided in [Drawing D5.16](#). Also see [D5.17](#) for emergency storage chamber details. Specific site design is required.

Preferably the storage volume shall be provided in the pumping wet well structure and upstream pipelines.

Where this is impractical, additional storage can be provided by additional manholes or horizontal chamber(s) made up from large pipes diameters.

For all sole purpose storage facilities the benching shall be at a minimum gradient of 1 in 3 to allow self-draining. A central channel within the storage well shall be at a minimum of 1% gradient.

If the storage chamber is designed as a horizontal pipe, the chamber must be provided with an automated wash down facility. The minimum gradient of the horizontal pipe shall be 2%.

Where storage is developed within the upstream pipework and normally carries wastewater flow these structures must have the benching constructed to cater for the normal operation, with a seamless progression to the benching required for the free drainage post emergency.

Structural Stability

The buoyancy of the storage chambers shall be determined as per the methods used for the wet well.

5.2.10.8 Rising Main

Sizing

The rising main will be a minimum size of DN80 and designed such that the minimum velocity, with one pump operating, is at least one metre per second and the maximum velocity, with all pumps operating, is less than or equal to three metres per second. Where a configuration does not allow for at least one start per hour, the agreement to the proposed configuration will need to be obtained from council.

Design should ensure that one pump run occurs per hour under dry weather flow. The pump run duration should be designed to ideally replace the rising main volume during a single run.

Additional isolating valves will be required on rising mains longer than 100 metres.

Where the length of the rising main is such that the volume of sewage exceeds the storage capacity of the wet chamber then additional isolating valve(s) shall be required.

Connection to Downstream Wastewater System

Rising mains shall discharge into a receiving manhole in accordance with the detail on [Drawing D5.9](#).

The point at which the pumping station is connected to the existing public wastewater system will be governed by the capacity of the network downstream from that point. The capacity of the gravity pipeline system to which the station discharges, shall be calculated to ensure the system will accommodate the discharge when all pumps are operating in combination with the peak wet weather flow from the adjoining gravity network.

Rising Main Layout

Wherever possible, the rising main shall be designed on a positive gradient avoiding high and low points and therefore minimise the need for air release and scour valves.

To accommodate all out of balance forces on the main its installation and design shall be similar to that of a watermain incorporating suitable anchorage at all changes of direction.

Material Selection

Refer [Acceptable Products Section 8](#).

Isolation

Downstream from the rising main flow meter, no closer than two diameters to a flow monitoring device, an isolation valve will be installed to allow work to occur on the pump set without need to drain the entire rising main volume or for high service stations to isolate the rising main in case of emergency bypass.

Bypass Outlet

For stations that have a design service level of greater than 20 L/s PWWF or the depth of the well is greater than 4.0m a rising main bypass outlet as shown in [Drawing D5.9](#) shall be provided and located between the flow meter and the rising main isolation valve and no closer than two diameters to the flow metering device. This outlet is to be utilised in the event of a failure either in the downstream catchment or the rising main during which time a temporary line can be installed to divert pump output to transport tankers.

Air Valve

Air relief valves shall be fitted as necessary and/or as required by Council for the purpose of automatic relief of gas build up within the rising main.

Valves solely for the purpose of wastewater applications.

Each air relief valve is to be housed within a separate manhole structure no less than 1050mm in diameter and located ideally out of the carriageway.

Scour Valve

Scour valves shall be fitted as necessary and/or as required by Council for the purpose of removing accumulated sediment built up within low lying areas of the rising main that potentially lead to a reduction in flow capacity.

Scour valves shall discharge to a receiving chamber and each scour point shall have vehicle access for tanker truck for the collection of scoured material. Suitable structures for containment of potential spillage are to be provided in the design.

Gross Solids Protection

The inlet to the overflow pipe shall be baffled to restrict the entry of solid floatable material.

5.2.10.9 External Services

The successful operation of the wastewater pumping station relies on the provision of external services and as such these services must be sized correctly for the operation loads experienced at commissioning of the station and where staged development of the station occurs, as a result of final catchment utilisation, that capacity is installed prior to commission or a detailed succession plan is provided including any approvals from service providers for these increases.

These services include, but are not limited to:

- Wash Water
- Power
- Stormwater
- Wastewater (receiving catchments)

- Telemetry wireless pathways

Wash Water

All pump stations shall be provided with a water supply of DN50 PE as used for water supply ridermains.

Wastewater pump stations are a 'High Hazard' risk requiring reduced pressure zone type backflow prevention devices installed above ground level. The backflow prevention device is to be positioned adjacent to the electrical control cabinet as shown on [Drawing D5.7](#). The backflow prevention device shall be installed within a separate housing as shown in [Drawing D5.20](#).

The exact size of the water connection is derived from the wash down flow requirement of the emergency storage chambers.

A second water supply connection (including 24VDC solenoid valve) shall be installed on the RPZ outlet to facilitate supply should a wash-down sprayer be installed (refer to [Drawing 5.17](#)). The solenoid valve is to open when the pump well low level float switches the pump off, and remain open for 10 minutes.

Power

The Council will only provide the minimum specification for sizing and selecting electrical equipment. It is the responsibility of the designer to determine the suitability and requirement of electrical equipment and connections with the network utility supply operator. The power account shall be opened by Council at the request of the developer/contractor and after installation of the cabinet.

Stormwater/overland flow

The stations are to be designed with a layout such as to afford free draining of stormwater away from cabinets and well openings.

5.2.10.10 Electrical and Telemetry

Councils have different electrical and telemetry specifications and will provide them on request.

The alarm and operational data control system is to be installed by the developer/contractor. However some councils have specialist contractors that they may require to be used, but at the developer/contractor's cost.

Control Levels

Control/Alarm settings shall generally be as follows:

Table 5-10: Control/Alarm Settings

CONTROL TYPE	LEVEL
Low Level Alarm	Set to activate if the water level drops below cut out level for more than 1 minute.
Pump Stop Level	50mm above minimum submergence level of pumps
Duty Pump Start Level	150mm below incoming wastewater invert level
Standby Pump Start Level	100mm above duty cut-in level

CONTROL TYPE	LEVEL
High Level Alarm	100mm above standby cut-in level
Critical (Overflow) Alarm	Set at overflow level
Critical (Overflow) Alarm	Set at overflow pipe invert level
For stations with dedicated storage volumes	
Emergency Storage in Use	Set to activate at inlet level to emergency storage.
Storage at 50% Level	Set to activate when emergency storage capacity is at 50%.
Storage Full Level	Set to activate when emergency storage capacity is Full.

Critical (Overflow) Float Switch

One float switch shall be installed to provide an alert at the point of loss from the wastewater network typically at or near the pump station. The float switch shall be wired to the telemetry to provide a ‘critical level alarm’ and to override relay to operate the pumps in the event of the level control system failing.

The float is to be positioned at or upstream of the point of overflow from the network. Where the point of installation is separate from the wetwell, the float is to be connected by a 50mm duct to the cabinet plinth.

5.2.10.11 Pump Design

Pump Selection

The pump system shall be an N + 1 system where, one duty pump is required for duty and an identical standby pump is required as a standby backup.

The pumps shall be operated from a three phase electrical power supply system.

Pumps shall be of Flygt small to medium head range submersibles, NP version, or similar as per [Acceptable Products Section 8](#).

The pumping range shall be selected to give greater than 1 and not more than 15 starts per hour.

The pumps are to be connected by way of a ‘duck foot’ discharge pedestal to enable the removal and manipulation of the pump from the top of the wet well.

In selecting the appropriate pumps the operating conditions shall correspond as closely as possible to the point of maximum pump efficiency. However, final pump selection must be approved by the Council in order to facilitate some standardisation of pump model and impellor sizes.

Table 5-11: Criterion for Pump Selection

RANK	CRITERIA
1	Level of Service Peak Wet Weather Flow
2	Operations and Maintenance Energy Consumption (kW/m ³) Fleet Compatibility
3	Cost of Investment Pump

RANK	CRITERIA
	Rising Main Diameter
4	Downstream restrictions Network Capacity Impact

In calculating the system head losses, the effects of all bends and fittings beyond the pump discharge bend shall be allowed for, together with the rising main friction losses.

The system static head shall be based on the difference in level between the centreline of the inlet face for the pump discharge bend and the highest point on the rising main system.

The rising main system curve is to be modelled using Colebrook White formula. Calculations of friction loss should be carried out based on roughness 'k' values of 1.5m and 0.5mm to ensure that the selected pump is capable of operating over this range of duty points.

Risers and Valve Sizing

The pumpset riser is defined as all pipework between the discharge bend to the inlet of the rising main isolation valve.

Internal pipework for each pumpset will be at a minimum of that determined by the pump discharge bend. Where there is a difference in the size between the discharge bend and subsequent steel work the reducer is to be immediately post discharge bend and/or prior to isolation valve if needed.

The valve installed along the pump set riser will be of a similar dimension to the pipework.

Isolation valves for each pump set will be of a quarter turn eccentric plug type with ability to lock in either open or close position using a (standard padlock).

Non-Return Valves

The installation of a non-return valve on each pump set is required to ensure the pumps are protected from reverse flow and that flow from a pump is not returned to the well through the standby pump reducing operational capacity.

Where the dynamic head for a pump is less than 15m, as measured at the location of the non-return valve, a ball type valve can be used. For those stations that experience levels greater than 15m a resilient seated rubber flap check valve is to be used. Flap check valves are to be installed with an external indicator arm.

For those stations where the total head is above 30m a detailed engineering design solution is to be provided showing the limitations on the system for water hammer following the controlled shutdown of pumps (excluding power failure).

Flow Meter Sizing

The flow meter model shall be as set out in the [Acceptable Products Section 8](#) and sized for the rising main.

The Pump Station design must ensure the flow meter is fully charged at all times.

The transmitter shall be located in the cabinet with analogue and digital information connected to the Council's telemetry system.

The meter is to be housed in a 1050mm diameter manhole with 400mm clearance from the invert and shall be connected to the cabinet by ducting. The ends of the ducts are to be sealed to prevent ingress of soil and moisture.

5.3 CONSTRUCTION

5.3.1 Pipeline Construction

This section covers the installation requirements for all piped wastewater networks.

The installation of pipelines shall be carried out in accordance with the relevant AS/NZS standard.

5.3.1.1 Materials

Refer [Acceptable Products Section 8](#).

5.3.1.2 Embedment

The designed trench width shall be the minimum width to allow pipes to be safely laid and all embedment material properly and sufficiently compacted.

Embedment and fill shall keep pace with the excavation and laying of pipes so that not more than 15m of pipes shall be left exposed in open trench where this could represent a danger to road users.

The foundation shall be able to support all design loads placed on it for the duration of the lifecycle of the pipeline it supports. Where the bottom of the trench will not provide adequate support for the pipe during construction, the developer (or their agent) shall be contacted to provide a suitable means to stabilise trench foundation. Acceptable methods include:

- a) Groundwater drainage
- a) Use of geotextile fabric
- b) Cement stabilisation or
- c) Removal of unsuitable material and replacement with compacted selected material

No embedment material shall be placed or pipes laid before the trench foundation has been inspected and accepted by a suitably qualified drainlayer or engineer.

The various zones comprising the embedment depth shall be laid in ascending order. Each zone shall be laid in accordance with the approved design. Each zone shall contain the specified selected material and compacted to the required density.

Where pipelines have protruding projections such as sockets, flanges or couplings, a suitable recess shall be provided, in the supporting material, to ensure the pipeline is fully supported along the pipe barrels.

Pipes shall be laid with product labelling uppermost in the trench.

5.3.1.3 Fill

General

The trench or embankment fill material, shall be as specified. Where reuse of previously excavated material is proposed its use shall be approved by the designer. Under no circumstance shall the density of the fill material be less than that of the material prior to excavation. When compacting in layers the depth of each layer shall be as specified by the designer.

The depth of fill must comply with the relevant AS/NZS standard for the pipe material (see References).

Mechanical compaction of the fill material directly above the pipe shall not be commenced until the depth of cover above the top of the pipe is adequate to prevent damage.

Compaction equipment which can produce horizontal or vertical earth pressure on the pipeline, which can cause damage or excessive distortion of the pipeline, shall not be used.

Fill outside a Transportation Corridor and other Trafficked areas

Trench or embankment fill shall be compacted in layers to the specified finished level. The designer shall specify a testing regime to verify the compaction effort meets the density specified.

Fill in a Transportation Corridor and other Trafficked areas

Trench or embankment reinstatement shall conform to the requirements shown on [Drawing D3.2.3](#) 'Trench Reinstatement' contained within the Transportation Section of this document. Trench or embankment fill shall be compacted in layers to the specified finished level. The designer shall specify a testing regime to verify the compaction effort meets the density specified to support the designed traffic loading.

5.3.1.4 Tolerances

Pipes shall be accurately laid to the lines, levels and gradients shown on the Drawings using pipe-laying laser equipment.

The permissible deviation of the alignment and gradient of pipelines shall be as per AS/NZS 2032. There shall be no steps at the junctions between successive pipes and no point in the pipeline shall be lower than any downstream point.

Where the variation exceeds the tolerance Council may order the removal and relaying of any affected pipes.

Invert Levels

The permissible deviation from the designated level of the invert at each manhole or structure shall be ± 50 mm, provided that the fall between successive manholes or structures shall be at least 90% of that specified.

Horizontal Alignment

The permissible deviation of the horizontal alignment between manholes or structures shall be ± 100 mm.

5.3.2 Trenchless Construction

5.3.2.1 General

Trenchless technology may be preferable or required as appropriate for alignments passing through or under

- a) Environmentally sensitive areas
- b) Built-up or congested areas to minimise disruption and reinstatement
- c) Railway and major road crossings
- d) Significant vegetation
- e) Vehicle crossings

Trenchless construction shall only be used for applications in which the specified tolerance can be achieved.

Pipes used for trenchless installation shall have suitable mechanically restrained joints, specifically designed for trenchless application, which may include integral restraint, seal systems, or heat fusion welded joints.

Any trenchless technology and installation methodology shall be chosen to be compatible with achieving the required gravity pipe gradient — refer to manufacturer's and installer's recommendations.

5.3.2.2 Installation Methods

Trenchless installation methods for new pipes include

- a) Horizontal directional drilling (HDD) (PVC with restraint joint/fusion welded PE)
- b) Uncased auger boring/pilot bore micro-tunnelling/guided boring (PVC with restraint joint/fusion welded PE)
- c) Pipe jacking (GRP/ reinforced concrete)

5.3.2.3 Pipe Detection Tracer Wire

When a pipe is installed by a directional drilling technique or bored through the ground, the pipe shall have a 'Tracer Wire' attached. This wire shall take the form of a continuous 2.5mm² multi strand (polythene sleeved) cable, strapped to the pipe wall by means of a minimum of two complete wraps of heavy duty adhesive tape, at a maximum of 3.0m intervals. The tracer wire shall be tested for electrical continuity.

5.3.3 Joints

5.3.3.1 General

Specification of joints shall be as follows.

- a) All pipes shall have flexible joints of an approved type, such as RRJ
- b) Concrete lined steel pipes shall be flexibly jointed (gibault with 'Denso' system or similar accepted product wrapped and sealed with outer wrapping).

- c) Joints shall be provided adjacent to manholes to the requirements of AS/NZS 2566 with the exception of PVC where proprietary connections may be used

5.3.3.2 Rubber Ring Joints

Rubber ring joints shall be installed strictly in accordance with the manufacturer's instruction. Care should be taken to ensure that the rubber rings are located evenly around the joint with no twists in them. The pipe shall be pushed to the witness mark.

5.3.3.3 Site Mortar Jointing of Pipes into Manholes

All mortar used for the 'on-site' jointing of drainage components shall be Expocrete 'UA' or an approved equivalent. The surface priming, mixing of components, application and cure period are to be in accordance with the manufacturer's instructions. Before backfilling the mortar shall be pushed firmly into the manhole/pipe cut out until the space is completely filled and the mortar exudes to the outside of the manhole riser.

5.3.3.4 Butt and Electrofusion Welded Jointing

Electrofusion welded jointing shall only be carried out by experienced certified PE welders.

The certifying organisation shall be acceptable to the Council. In addition, welders may be required to carry out satisfactory test welds for each joint type and to stamp the welder's number on each joint. Butt welds shall be, at least, 90% of the tensile strength of the parent pipe material, when tested in accordance with ISO 13953. All internal weld beads shall be removed in an approved manner, to be smooth and flush with the pipe inner surface, without compromising the strength of the pipe joint.

5.3.3.5 Jointing by Electrofusion Welding

Couplers shall be of the same rating of the pipe or superior and installed to the manufacturer's instructions.

5.3.4 Manholes

5.3.4.1 Channels and Benching

A semi-circular channel shall be formed in the concrete floor of the manhole. The benching shall rise vertically from the horizontal diameter of the pipe to the height of the soffit and then be sloped back at a gradient specified in Drawings [D5.1](#) – D5.3.

For changes in direction the flow channel shall be formed so that it presents an evenly curved flow path through the manhole. The cross section of the flow channel shall be uniform. In wastewater pipelines the main channel shall be lined with preformed channels, as per accepted products in Section 8. Benching shall be floated to a dense, smooth hard surface using 3:1 sand cement mortar and a steel float. Side branches shall be similarly formed with a smooth bend into the main channel.

For larger manholes and pipelines greater than 600mm in diameter the benching shall have step recesses as shown on [Drawing D5.2](#). A U3 standard of finish as specified in NZS 3114 shall be achieved.

5.3.4.2 Flexible Joints

All pipelines shall have a flexible joint adjacent to the manhole on all incoming and outgoing pipes not more than 600mm away from the manhole wall. The upper part of the pipe inside the manhole shall be cut back to the wall, the reinforcement cut out and the ends plastered with a cement mortar to a neat finish. Where the pipe is cut using a power saw the ends of the steel reinforcement shall be protected from corrosion by the application of epoxy before rust has a chance to develop.

5.3.4.3 Sealing of Manholes

Where precast manhole units are used, the joints of abutting units shall be sealed against ingress of water with Humes' Sealing Strip, Hynd's Grey Butyl Manhole sealant or similar accepted product and with epoxy mortar on the inside and outside of the joints.

5.3.4.4 Manhole Steps

Manhole Steps shall be of the type that meets the standard, accepted and included in [Section 8](#).

5.3.4.5 Concrete

All concrete shall have a minimum crushing strength of 20.0 MPa at 28 days, unless otherwise specified or detailed by Council.

5.3.5 Connections

All connections shall be sealed by watertight removable caps until such time as they are required.

All connections and disconnections to or from Council pipes and all works outside the property boundary shall be undertaken by Council or an approved contractor.

Connections shall be constructed as per drawing [D5.4](#)

5.3.6 Backfilling and Reinstatement

Backfilling shall keep pace with the excavation and laying of pipes so that not more than 15m of pipes shall be left exposed in open trench.

5.3.6.1 Outside of Transportation Corridor

Bulk backfill shall be placed in layers and mechanically compacted. The degree of compaction shall be such as to produce an in-situ density which shall not be less than that of the material prior to excavation, Refer to [Drawing D3.2.3](#). To establish the criteria for compliance, Scala Penetrometer tests shall be carried out along the line of the trench prior to excavation.

There shall be not less than one test per 50m of trench length. Compaction tests (or substituted Scala Penetrometer tests) shall be carried out for the full depth of the trench to within 300mm of the pipeline (subsequently referred to as the 'test area'). There shall be at least one test area per 50m of trench length, or, at least one test area per 50m³ of trench backfill, whichever method returns the greater number of test areas.

Compaction test results (or substituted Scala Penetrometer tests) shall be submitted to Council for approval, refer [Section 3 Transportation](#).

The area shall be reinstated as near as possible to the original condition.

All drains, fences and other structures shall be replaced or reconstructed to their pre-construction standard and in their original place.

5.3.6.2 Inside Transportation Corridor

Pipe trenches shall be backfilled using an approved hard fill placed immediately above the pipe embedment and reinstated as specified by [Drawing D3.2.3](#). The depth of the basecourse and type of finishing seal coat shall conform to the standard of the existing road construction.

Compaction test results (or substituted Scala Penetrometer tests) shall be submitted to Council for approval refer [Section 3 Transportation](#).

5.3.7 Pump Stations

5.3.7.1 Wet Well and Valve Chamber

The Pumping Station chamber shall be constructed from flush jointed Class 4 reinforced concrete pipes installed as shown on [Drawing D5.8](#). Care shall be exercised to ensure that the pump chamber is vertical and set to the correct levels before the station floor is poured. A precast base may be used, provided flotation of the chamber is prevented.

Pipe joints shall be sealed and made water tight using 'Expocrete UA' or an acceptable equivalent.

5.3.7.2 Foundations

Once excavated to a firm foundation free of any organic soil, the wet well pump station foundation shall be prepared with a layer of compacted GAP40 no less than 250mm thick followed by a capping of site concrete no less than 100mm thick.

5.3.7.3 Painting and Lining

Any block work mortar joints shall be pointed inside and outside and all cores filled with grout. The outside of the block work shall be painted with two coats of 'Mulseal' or acceptable equivalent in accordance with the manufacturer's specifications.

The internal walls of the well and valve chamber are to be painted using Sika Guard 62 or acceptable equivalent in accordance with the manufacturer's specifications and applied by a licensed Contractor.

5.3.7.4 Top Slab

The top slab shall be cast as shown on [Drawing D5.10](#). The placement of reinforcement shall be carefully controlled to ensure adequate cover. The lids and frames shall be carefully set into the concrete upstands so that they fit flush with the finished upstand level. All concrete shall be ordinary grade 21 MPa crushing strength.

The lid and frame specified on the drawings shall be constructed as shown on [Drawing D5.10](#). All reinforcing steel bars shall be grade 300 deformed bars complying with AS/NZS 4671. All nuts, bolts and washers shall be grade 316 stainless steel with an appropriate releasing agent applied prior to setting any nut. Where concrete is to be

poured around high density polyethylene pipe, the pipe shall be first wrapped with 1.5mm thick butynol sheeting.

5.3.7.5 Well and Chamber Lids

The primary covering lids are to be constructed as shown in [Drawing D5.14](#) as appropriate for the pump size selected at full development.

- a) All stainless welds are to be AS/NZS 2980, pickled to prevent corrosion. All metal to metal fasteners are to be coated with an appropriate releasing agent before installation
- b) All fasteners are to be 316 stainless steel
- c) All edges are to be made clean of burs or sharp edges
- d) Secondary Safety Lids required where depth is greater than 2.0m

5.3.7.6 Cable Bracket

The float and motor cables shall be secured by a grade 316 stainless steel bracket with ceramic insulators. The bracket shall be mounted in such a position as to be easily accessible from the lid opening as shown in [Drawing D5.8](#).

5.3.7.7 Pump Discharge Bends or Pedestal

The pump discharge holding down bolts shall be grouted in place and accurately positioned so that the 50mm dia. pipe guide rails stand vertically between the guide rail brackets and the discharge connection. Care is to be exercised in grouting in the bolts to ensure that they will not vibrate loose with use.

5.3.7.8 Guide Rails

Guide rails are to be fixed to the edge of the well, using stainless fittings with the guide rails installed vertically using the Flygt guide rail bracket. The guide rails are to be 316 schedule 10 stainless steel tube and each guide rail is to be of a single continuous pipe run with no joins, unless pre-approved by Council.

5.3.7.9 Riser

Each pump installed shall be fitted with an individual riser manufactured from 316 schedule 40 stainless steel tube, all welds are to be to AS/NZS2980, pickled to prevent corrosion. All flanges are to be of Table E.

Where a flange is installed on a horizontal pipework, the two bolts are to be placed so they are level at the top, on vertical sections the two bolts are to be perpendicular to the discharge bend inlet coupling base.

The riser for each pump consists of three major components, these being:

- The pump lift
- Valve wall penetration
- Non-return valve connector

5.3.7.10 Pump Lift

The pump lift component consists of a vertical section of pipe from the bellows located on the discharge bend to the valve set elevation. The section is to contain a single 90 degree flanged bend.

If the design requires that the pump lift component is to be connected to a discharge bend of a smaller diameter, this is to occur by way of a reducer fabricated into the base of the vertical riser and the bellows sized to meet the discharge bend.

Where the pump lift component riser is greater than 3.0m, additional support brackets are to be installed, as shown in [Drawing D5.8](#) at 2.0m intervals, measured down from the centre line of the valve wall penetration.

5.3.7.11 Valve wall penetration

A flange is to be installed prior to entering into the valve chamber wall, no closer than 200mm to the wet well wall facing. The penetration through the valve chamber wall shall be horizontal and centred vertically over the pipe discharge bend. No partial bends for realignment shall be used without specific authorisation from Council.

Where the pipe penetrates the valve wall, a square stainless steel flange shall be welded to the pipe and bolted to the wall with dimensions at least 2.5 times the external pipe diameters and fixed with M16 stainless steel Chemset studs. The penetration hole for the riser to pass through shall be approximately 20mm larger than the external diameter of the pipe and extend a sufficient length to the cut off to fully allow the gibault connection to slide fully onto this length of pipe work to release all downstream pipework.

A non-return valve connector is to be fitted with a length no less than 100mm plus 60% the overall length of the gibault. It shall be fitted with a Table E flange and welded as per the required specifications and a 15mm BSP threaded socket welded to the centre line of the pipe with a stainless steel plug no closer than 50mm to valve flange.

5.3.7.12 Non Return Valve and Riser Isolation Valves

The non-return and isolation valves shall be installed as per the manufacture's requirements, post isolation valve.

5.3.7.13 Collection Manifold

The individual riser is to be joined together by a collection manifold which continues through the exterior valve wall including puddle flange over each pipe. On leaving the valve chamber, the individual risers are to be joined together using 45 degree connections. On collection of all individual risers the manifold is to proceed with a minimum straight length, free of fittings, of no less than 5 diameters prior to termination in a flange, for connection to the flow meter. The downstream section of the flow meter is to continue in stainless steel without fittings for at least 2 diameters, until either a rising main bypass tee fitted or the isolation valve.

All fastening bolts are to have a releasing compound applied prior to installation.

5.3.7.14 **Storage**

The Emergency Storage chamber shall be constructed from Skid Ring Jointed minimum Class 2 reinforced concrete pipes installed as shown on Drawings [D5.17](#) and [D5.18](#).

The entire storage tank shall be painted inside as per the requirements of the wet well.

Any washing fixtures are to be constructed using 316 Stainless Steel pipe and fixtures.

5.3.7.15 **Miscellaneous**

Reference shall be made to [Section 3 – Transportation](#) for design and construction requirements for kerbing and vehicle crossings and [Section 7 – Landscaping](#) for fencing requirements.

5.3.7.16 **Odour Control**

At present Council is not installing odour control on new pump stations. However provision of space free of services must be provided as shown in [Drawing D7.6](#).

5.3.7.17 **Reinstatement**

Refer Section 5.3.6.

5.3.7.18 **Electrical Cabinet Plinths**

The electrical cabinet plinth is to be constructed as per [Drawing D5.19](#).

5.3.7.19 **Direct Buried Cable**

Where specified cables are laid directly in the ground, they shall be located not less than 0.6m below ground on a 50mm thick bed of clean sand. The trench shall be backfilled with a 75mm thick layer, measured from the top of the cable, of clean sand. Lengths of 'Mag- Slab' cable cover shall then be laid end to end to provide cable protection. The trench shall then be further backfilled with clean sand or soil, free from rock, stones or other debris, to a level 200mm below the surface. Orange PVC signal tape shall then be laid and backfilling completed, the surface being restored to Council's satisfaction.

5.3.7.20 **Cable Ducting**

The following cable ducts are required

- One pump cable duct and one control cable duct of 100mm dia. shall be installed from the base of the electrical control cabinet concrete plinth to the pump station chamber
- One 100mm duct will be installed in the plinth for the mains cable
- A 50mm duct will be installed from the electrical control cabinet concrete plinth to the flow meter
- A further 50mm duct will be installed for each of the emergency storage spray wash control solenoid and/or a distal float overflow if fitted

Each cable duct is to be fitted with a pull cord for future cable repair works and is to be sealed, to restrict corrosive fumes entering the electrical cubicle, by way of expanding foam encased in a plastic liner to allow ease of future removal.

5.3.7.21 **Electrical Cabinet Supply**

Councils have different cabinet componentry requirements and will provide details on request.

A six week lead in time is required in order to supply the standard two pump cabinet.

The cabinet shall be supplied by an electrical contractor acceptable to council and with a Certificate of Compliance.

The Developer/Contractor is responsible for providing the connection to the electrical network, installation of power meter and connection of the external fittings, including but not limited to:

- Pumps control and protection
- Floats
- Level sensor
- Any wash solenoids or odour controls as required by the site design

5.3.8 **Testing and Inspections for Pipelines**

All wastewater mains and branch pipelines, including extended connections, shall be inspected during construction. On completion of all other engineering work within the subdivision, there shall be a final test conducted.

Council requires a Council observer present during the test. A minimum of 24 hours' notice is required to be given to Council before the test is carried out, so that arrangements for an observer can be made. The Developer/Contractor shall provide all fittings and materials to carry out the test.

5.3.8.1 **Inspections**

The Developer/Contractor needs to ensure that inspection and subsequent approval is granted before continuing with the installation, failure to follow this process may mean that the Developer/Contractor is required to remove items or excavate work to allow inspection of standards of installation. These inspections include:

- Set out
- Excavation and bedding
- Backfill
- Pre-pour Form and Reinforcing
- Pre-Cover Installation
- Water Tightness
- Rising Main Pressure Test
- Electrical Inspection

5.3.8.2 Non-Pressure Pipeline – Field Leakage Tests

The materials and workmanship used shall be carried out by at least one of the following methods:

- Low pressure air testing
- Hydrostatic testing

Refer to Appendix C2 of NZS 4404 for testing methodology.

5.3.8.3 Manhole Leakage Tests

The materials and workmanship used shall pass one of the following tests.

- A Low pressure test as described in 5.3.8.2, for manholes up to 3.5m depth only.
- Or a Vacuum Test

Vacuum Test

The vacuum test creates differential pressure between the inside and outside of the manhole. This test shall be completed with the manhole completely backfilled and the lid in place.

Procedure

- a) Clean manhole thoroughly
- b) Seal openings using properly sized or inflatable plugs
- c) Connect seal plate to manhole opening
- d) Draw vacuum of -254mmHg (or -338.6mbar) and isolate valves
- e) Hold test time according to the manhole sizes as listed in the table below:

Table 5-12: Manhole leakage test - hold test time

DEPT H (M)	MANHOLE DIAMETER (MM)							
	750	1050	1200	1350	1500	1800	2400	3000
	TIME (S)							
<2	11	17	20	23	26	33	39	45
3	14	21	25	29	33	41	49	57
3.5	17	25	30	35	39	49	59	69
4.3	20	30	35	41	46	57	69	81
5	22	34	40	46	52	67	81	95
5.5	25	38	45	52	59	73	87	101
6	28	42	50	53	65	81	97	113
6.7	31	46	55	64	72	89	107	125
7.3	33	51	59	68	78	97	115	133
8	36	55	64	75	85	105	125	145
8.5	39	59	69	81	91	113	135	157
9	42	63	74	87	98	121	145	169
9.5	46	69	81	94	105	129	153	177
10	49	74	87	98	113	139	165	191

- f) Release the vacuum and remove the test gear and plugs

Acceptance

- a) For the duration of the test the vacuum did not drop below -228mmHg (or -304mbar).
- b) There are no visible wet patches or “sweating” at any of the pipe penetrations, seals or riser joints.

5.3.9 CCTV Inspections

CCTV inspection shall be carried out on 100% of all new systems and shall be completed once the road surface is to a finished level and prior to any road surfacing.

CCTV inspections and deliverables shall be in accordance with The New Zealand Pipe Inspection Manual with the expectation that new pipes will score a ‘1’.

All defects are to be fixed to the satisfaction of Council. Where faults are found and repaired the section of pipe shall be re-filmed to ensure that there are no further problems.

5.3.9.1 Particular Specification

Slope corrections shall be carried out where the pipe alignment is out of tolerance.

The pipe shall not be in service during the CCTV inspection. The pipe shall however be jetted/cleaned to ensure all debris and other material are removed prior to CCTV so that no ‘Service Grading’ defects are present. In addition, the CCTV camera shall travel upstream with a small flow of water travelling down the pipe towards the camera. Still images of all severity ‘L’ and ‘M’ defects shall be provided.

5.3.9.2 Deliverables

The following deliverables are required.

- a) Computer generated log sheets
- b) CCTV inspection record Digital Video format
- c) Electronic data in suitable format for Council to download to its asset management system.
- d) CCTV footage needs to be referenced to ensure manhole names and DDTS ID's link footage to as-builts
- e) Still images in electronic format and hard copy
- f) CCTV summary sheets in electronic format and hard copy

5.3.9.3 Header Information Required

The Developer shall provide the following header information with each inspection record.

- a) Name of main Contractor
- b) Name of CCTV Contractor
- c) Name of Operator
- d) Date and time of inspection

- e) Location (e.g. street name)
- f) Upstream manhole number notated with Council’s manhole asset ID
- g) Downstream manhole number notated with Council’s manhole asset ID
- h) Material type and diameter
- i) Pipe function

5.3.10 Pump Station Commissioning

All pumping stations shall undergo a series of inspections and tests during construction including:

Table 5-13: Pump Station Test Schedule

INSPECTION	TEST
Pre Installation	Electrical Cabinet Inspection and Testing
On-site	Civil Inspections
	Telemetry
	Pump Station Tests
	Post Cabinet Installation
	Station Set Up
Post-Installation	Final Sign Off
	Commissioning Tests
	Rising Main Test

5.3.10.1 Onsite Inspections

Civil Inspections

Civil inspections by the Developers Representative and Council will occur throughout the civil construction of the pump station. This will cover areas such as the wet well, valve chamber and storage construction, the station inlets, the rising main, discharge manhole, any other associated pipework with the station and the odour bed if this is to be installed.

Telemetry

Notification of the upcoming commissioning must be made to Council 14 days in advance, to ensure that SCADA is set up. The SCADA must be pre-commissioned in consultation with Council to ensure that all alarms are being received by the Council’s telemetry system.

Pump Station Tests

Once installed, the equipment is to be adjusted where necessary and placed into operation as near as possible in the manner, and under the conditions it will operate in practice. Tests are made to ensure all protective devices, and controls are fully operational.

Performance tests will also be made to verify the designed performance under operational conditions.

The pump station will not be commissioned/deemed operational until all the following documentation (electronic format) has been provided.

- a) Plant data sheets
- b) As-built drawings for Civil, Mechanical and Electrical (SPS and RM)
- c) SCADA programme
- d) Job Safety analysis for all routine maintenance tasks to be performed at the pump station
- e) Operational and maintenance manuals inclusive of pump system curves
- f) Copy of concrete compressive strength and slump test results
- g) Copies of Rising Main Pressure tests
- h) Contingency Plan for bypass pumping
- i) Factory pump test results
- j) Switchboard factory and site acceptance test certificates completed and signed.

Additional requirements:

- a) Council representatives must attend the station commissioning.
- b) The pre-commissioning record sheets shall be completed and lodged with Council five working days prior to the planned commissioning date.
- c) Pumps should not be accepted if the maximum flow delivery rate is substantially above the specified limits. Such excess flows can have adverse hydraulic effects at the Wastewater Treatment Plant or at other downstream elements in the system.
- d) Prior to the start of the pump station tests, the site is to be inspected for suitability of running of the pumps and is to include, but not be limited to the following.
 - (i) Lifting chains are attached and secured to the holding brackets
 - (ii) The electrical cable is free of the pump and any excess cabling is coiled and secured at the top of the well and free of the pump path along the guide rail.
 - (iii) All tests and checks required for provision of certificate of electrical compliance by a registered electrician
 - (iv) Receipt of factory test certificate for the pumps and present for sighting at site by Council representatives
 - (v) Ensuring all pumps are clear of all debris and tools
 - (vi) Checking signals from all level control equipment to ensure safe operation and to ensure the pumps will not run dry

Following the clearance of the site for pump operation, each piece of equipment can singly and in their possible combinations be operated to confirm system and component performance.

This will involve but not be limited to the following.

Table 5-14 : Pump Tests

PUMP TEST	SPECIFIC REQUIREMENTS
-----------	-----------------------

PUMP TEST	SPECIFIC REQUIREMENTS
Impellor clearance	Ensure the impellor clearance is set correctly for optimal performance and that manual operation of the impellor identifies no resistance to free movement.
Pump rotation	This is to be confirmed by running the pump out of the well using a standard bump test. Check the pump travel up/down the guide rails is free with no adverse sticking.
Testing of duty equipment and performance	<ul style="list-style-type: none"> • Measurement of duty pump performance is to be made immediately prior to the duty stop level • Measurement of each pump individually • Measurement of: <ul style="list-style-type: none"> ○ Current Draw, CT ○ Current Draw, as read by analogue display ○ Flow • Pump Seating correctly with no flow pass from discharge coupling • Pumps open NRV valves • NRV close on completion of pumping and do not allow draining of the rising main to the well
Testing of Duty and Standby equipment and performance	<ul style="list-style-type: none"> • Measurement of duty pump performance is to be made immediately prior to the combined stop level • Measurement of: <ul style="list-style-type: none"> ○ Current Draw, CT ○ Current Draw, as read by analogue display ○ Flow
Critical alarm float activation of pumps without the aid of the PLC controls and shutoff at low level float return	Both pumps start when the critical alarm float is tipped.
Vibration checks	No adverse vibration is detected on the pump system, pipe work or movement is detected on the pipe work at cessation of the pump operation.

Where any of the above fail to satisfy the requirements of the specification or Council, the Developer/Contractor must correct the defect and retest.

On the successful completion of the pump test the station is to be left in automatic float level operational mode.

Post Cabinet Installation

The commissioning of the electrical components will be on the mains supply to the cabinet and the external downstream electrical connections.

Table 5-15 : Telemetry Connection and Electrical Cabinet Commission Test Schedule

TEST REQUIRED	SPECIFIC REQUIREMENTS
Mains supply	
Generation Connection	Phase Rotation

TEST REQUIRED	SPECIFIC REQUIREMENTS
Alarm and Controls	<p data-bbox="651 226 1436 338">As no standard rotation direction can be specified for the connection to the supply mains, should there be a difference between the mains supply and the generator rotation, differences are to be rectified at the generator supply connection.</p> <ul style="list-style-type: none"> <li data-bbox="651 367 863 394">• Phase Fail relay <li data-bbox="651 405 807 432">• Spill inhibit <li data-bbox="651 443 900 470">• Final US calibration <li data-bbox="651 481 1050 685">• Digital Controls <ul style="list-style-type: none"> <li data-bbox="687 517 858 544">○ Critical level <li data-bbox="687 555 874 582">○ Standby Start <li data-bbox="687 593 836 620">○ Duty Start <li data-bbox="687 631 884 658">○ Common Stop <li data-bbox="687 669 1050 696">○ Wash Solenoid(s) (if installed) <li data-bbox="651 707 890 1077">• Analogue Controls <ul style="list-style-type: none"> <li data-bbox="687 734 884 761">○ Analogue High <li data-bbox="687 772 836 799">○ Duty Start <li data-bbox="687 810 874 837">○ Standby Start <li data-bbox="687 848 778 875">○ Stop <li data-bbox="687 887 884 913">○ Storage in Use <li data-bbox="687 925 874 952">○ Storage @ 50% <li data-bbox="687 963 852 990">○ Storage full <li data-bbox="687 1001 879 1028">○ Pump 1 Amps <li data-bbox="687 1039 879 1066">○ Pump 2 Amps <li data-bbox="687 1077 778 1104">○ Flow
Pump operation on Manual	
Pump operation on Automatic	
Pump Duty Change over	
Mini-CAS	
Overload settings	
Soft-Start settings (if fitted)	

At the successful completion of the above electrical tests, the Developer's electrical representative is to complete the site's Electrical Certificate of Compliance. Provision of this document to Council will mark the successful completion of electrical and control commissioning.

Station Set Up

On completion of the Developer's installation of the electrical cabinet at site, the final radio connection to the Council telemetry network will be carried out by Council or their nominated agent.

On completion of the network connection the station will be available for final electrical commissioning which will be carried out by Council's current service supplier in conjunction with Council as well as the Developer for the mechanical and electrical installation. Two weeks advance notice shall be given of the programmed commissioning date.

Final Sign Off

This is to cover mechanical, electrical and telemetry aspects. On completion and acceptance of performance the Developer can apply for the station to undergo a Commissioning test.

Council representatives shall be present at the test and a minimum of 5 working days' notice shall be given to Council prior to commissioning taking place.

Any defect, found or non-conformance to agreed standards, shall be rectified prior to acceptance of the pump station by Council.

Commissioning

As a follow on from electrical testing, the Developer shall allow for a full commissioning of the switchboard, associated pumps, soft starters, control, alarms, and measurement instrumentation and telemetry system and commissioning of the filter and extractor fan if installed.

Included with this requirement is the commissioning by standby generator of the switchboard and interconnections. Full operational checks and pump running shall be carried out on the Standby Power generator supply.

A fully scheduled pre-commissioning and commissioning program shall be derived and submitted to Council. This shall include (but not necessarily be limited to) defining all activities to be undertaken after the testing is completed. Such pre-commissioning checks and commissioning shall allow co-ordinating with the Council's operational staff and allow for their input.

Commissioning in the regard to the confirming of operational safety and reliability only after all non-liveness tests have been completed. Full written records of all operational set points, readings of all dials, instrument digital displays for the whole range of operational equipment, alarm indications etc., shall be taken at the time, on site, and presented in a tabulated and written/typed form to Council.

- Site Installation of Electrical Cabinet
- Plinth
- External Wiring to Auxiliary Units
- 3 phase Supply
- Pumps
- Floats
- Ultra-sonic
- Wash Solenoids
- Flow meter

5.3.10.2 Rising Main Test

Refer to NZS 4404 Appendix C3.

5.3.11 As-built Information

Upon completion of construction work, copies of As-built plans and data attributes of the completed works, as described in Clause 1.9 of [Section 1: General](#), shall be

provided to the Council. Separate plans are required for wastewater, stormwater, and water supply.

Responsibility for providing the plans and associated data shall lie with:

- a) The Developer, in the case of land development (urban and industrial subdivision).
- b) The Contractor, in the case of works constructed for Council under contract to Council.

FORMS AND CHECKLISTS

Table 5-16 : Forms and Checklist Register

NUMBER	TITLE
F5.1	Design Confirmation
F5.2	Pipe Laying Checklist
F5.3	Manhole Checklist
F5.4	Trench Backfill Compaction Test
F5.5	Deleted – May 2018
F5.6	Final Inspection
F5.7	Pump Station
F5.8	Verification of Flow Meter Draw Down Test

F5.2 WASTEWATER PIPE LAYING CHECKLIST

Engineering plan number(s):					
Name of certified drainlayer:					
Location: Pipe length (MH To MH)	to	to	to	to	to

Pipe Laying Checks

Trench Safety	<input type="checkbox"/>	<input type="checkbox"/>	<input type="checkbox"/>	<input type="checkbox"/>	<input type="checkbox"/>
(d) Shield	<input type="checkbox"/>	<input type="checkbox"/>	<input type="checkbox"/>	<input type="checkbox"/>	<input type="checkbox"/>
(e) Batter	<input type="checkbox"/>	<input type="checkbox"/>	<input type="checkbox"/>	<input type="checkbox"/>	<input type="checkbox"/>
(f) Other	<input type="checkbox"/>	<input type="checkbox"/>	<input type="checkbox"/>	<input type="checkbox"/>	<input type="checkbox"/>
Pipe size, quality, manufacturer, on acceptable products list	<input type="checkbox"/>	<input type="checkbox"/>	<input type="checkbox"/>	<input type="checkbox"/>	<input type="checkbox"/>
Set out	<input type="checkbox"/>	<input type="checkbox"/>	<input type="checkbox"/>	<input type="checkbox"/>	<input type="checkbox"/>
– Surveyors name _____	<input type="checkbox"/>	<input type="checkbox"/>	<input type="checkbox"/>	<input type="checkbox"/>	<input type="checkbox"/>
– Set out checked	<input type="checkbox"/>	<input type="checkbox"/>	<input type="checkbox"/>	<input type="checkbox"/>	<input type="checkbox"/>
Foundation support attached	<input type="checkbox"/>	<input type="checkbox"/>	<input type="checkbox"/>	<input type="checkbox"/>	<input type="checkbox"/>
– Dynamic cone penetrometer (DCP) results	<input type="checkbox"/>	<input type="checkbox"/>	<input type="checkbox"/>	<input type="checkbox"/>	<input type="checkbox"/>
– if under cutting required, note metreage and DCP results.	<input type="checkbox"/>	<input type="checkbox"/>	<input type="checkbox"/>	<input type="checkbox"/>	<input type="checkbox"/>
Record daily level check and confirm on grade	<input type="checkbox"/>	<input type="checkbox"/>	<input type="checkbox"/>	<input type="checkbox"/>	<input type="checkbox"/>
Bedding type and surround material: _____	<input type="checkbox"/>	<input type="checkbox"/>	<input type="checkbox"/>	<input type="checkbox"/>	<input type="checkbox"/>
Bulk Backfill material: _____	<input type="checkbox"/>	<input type="checkbox"/>	<input type="checkbox"/>	<input type="checkbox"/>	<input type="checkbox"/>
Bulk backfill compaction (DCP results from pipe to ground level attached)	<input type="checkbox"/>	<input type="checkbox"/>	<input type="checkbox"/>	<input type="checkbox"/>	<input type="checkbox"/>
Alignment – control points identified	<input type="checkbox"/>	<input type="checkbox"/>	<input type="checkbox"/>	<input type="checkbox"/>	<input type="checkbox"/>
Pressure test witnessed and passed by Council representative.	<input type="checkbox"/>	<input type="checkbox"/>	<input type="checkbox"/>	<input type="checkbox"/>	<input type="checkbox"/>

Service connections

All service connections in place, taped, and staked	<input type="checkbox"/>	<input type="checkbox"/>	<input type="checkbox"/>	<input type="checkbox"/>	<input type="checkbox"/>
As-built measurements taken, GPS located	<input type="checkbox"/>	<input type="checkbox"/>	<input type="checkbox"/>	<input type="checkbox"/>	<input type="checkbox"/>
CCTV pipe inspection data and comments supplied	<input type="checkbox"/>	<input type="checkbox"/>	<input type="checkbox"/>	<input type="checkbox"/>	<input type="checkbox"/>

Developer/Contractor

Date

F5.3 WASTEWATER MANHOLE CHECKLIST

Engineering Plan Number(s)					
Name of certified drainlayer:					
Location: Pipe length (MH To MH)	to	to	to	to	to
Manhole Construction Checklist	MH number				
Manhole size, quality, manufacturer on acceptable materials list	<input type="checkbox"/>	<input type="checkbox"/>	<input type="checkbox"/>	<input type="checkbox"/>	<input type="checkbox"/>
Set out /orientation	<input type="checkbox"/>	<input type="checkbox"/>	<input type="checkbox"/>	<input type="checkbox"/>	<input type="checkbox"/>
Sealing strip between risers	<input type="checkbox"/>	<input type="checkbox"/>	<input type="checkbox"/>	<input type="checkbox"/>	<input type="checkbox"/>
Benching					
• Height	<input type="checkbox"/>	<input type="checkbox"/>	<input type="checkbox"/>	<input type="checkbox"/>	<input type="checkbox"/>
• Alignment and cross section	<input type="checkbox"/>	<input type="checkbox"/>	<input type="checkbox"/>	<input type="checkbox"/>	<input type="checkbox"/>
• Half pipe lining (wastewater only)	<input type="checkbox"/>	<input type="checkbox"/>	<input type="checkbox"/>	<input type="checkbox"/>	<input type="checkbox"/>
• Step recesses (if applicable)	<input type="checkbox"/>	<input type="checkbox"/>	<input type="checkbox"/>	<input type="checkbox"/>	<input type="checkbox"/>
Flexible joints	<input type="checkbox"/>	<input type="checkbox"/>	<input type="checkbox"/>	<input type="checkbox"/>	<input type="checkbox"/>
Cutting and plastering of connections	<input type="checkbox"/>	<input type="checkbox"/>	<input type="checkbox"/>	<input type="checkbox"/>	<input type="checkbox"/>
Access details per drawings (e.g. manhole cover sited over steps).	<input type="checkbox"/>	<input type="checkbox"/>	<input type="checkbox"/>	<input type="checkbox"/>	<input type="checkbox"/>
Step irons including epoxy to outside recesses	<input type="checkbox"/>	<input type="checkbox"/>	<input type="checkbox"/>	<input type="checkbox"/>	<input type="checkbox"/>
Bedding type and surround	<input type="checkbox"/>	<input type="checkbox"/>	<input type="checkbox"/>	<input type="checkbox"/>	<input type="checkbox"/>
Bulk backfill compaction - Dynamic Cone Penetrometer (DCP) results attached	<input type="checkbox"/>	<input type="checkbox"/>	<input type="checkbox"/>	<input type="checkbox"/>	<input type="checkbox"/>
No debris in pipelines	<input type="checkbox"/>	<input type="checkbox"/>	<input type="checkbox"/>	<input type="checkbox"/>	<input type="checkbox"/>
Pipe invert fall through manhole	<input type="checkbox"/>	<input type="checkbox"/>	<input type="checkbox"/>	<input type="checkbox"/>	<input type="checkbox"/>
Pressure test witnessed and passed by Council representative.	<input type="checkbox"/>	<input type="checkbox"/>	<input type="checkbox"/>	<input type="checkbox"/>	<input type="checkbox"/>

Developer/Contractor

Date

F5.4 WASTEWATER TRENCH BACKFILL COMPACTION TEST SUMMARY (ATTACH INDIVIDUAL TEST REPORTS)

Technician Carrying out Tests:			
Location:			
Plan No(s):			
From MH		to MH	
Acceptance Criteria:			
Tests by:			

(attached)

Analysis of Results

Trench backfill completed satisfactorily

or

Trench backfill requires remedial work as follows:

-

Developer/Contractor

Date

F5.6 WASTEWATER PIPE NETWORK - FINAL INSPECTION CHECKLIST

Site/Location:		
Developer/Contractor:		
SUB _____ / _____		Contract No:
Developer to verify checklist prior to meeting:	Developer Check	Council Rep Check
6. All checklists completed (add form numbers)	<input type="checkbox"/>	<input type="checkbox"/>
7. All lines flushed out	<input type="checkbox"/>	<input type="checkbox"/>
8. All required CCTV inspections carried out, reviewed and any re-work completed.	<input type="checkbox"/>	<input type="checkbox"/>
9. All manholes checked (eg.infiltration, plastering)	<input type="checkbox"/>	<input type="checkbox"/>
10. All backfilling complete and tidied up	<input type="checkbox"/>	<input type="checkbox"/>
11. Pressure test completed and witnessed	<input type="checkbox"/>	<input type="checkbox"/>
12. Final as-built and operational plans attached for site inspection	<input type="checkbox"/>	<input type="checkbox"/>

Site Meeting		
13. Inspect all lines	<input type="checkbox"/>	<input type="checkbox"/>
14. Inspect all manholes and catchpits	<input type="checkbox"/>	<input type="checkbox"/>
15. Inspect SW inlet and outlet structures	<input type="checkbox"/>	<input type="checkbox"/>
16. Secondary flowpaths and detention ponds	<input type="checkbox"/>	<input type="checkbox"/>
17. Works on third party land completed to satisfaction of owner	<input type="checkbox"/>	<input type="checkbox"/>
18. Wastewater pumping station data complete and test results (Form F5.7) attached	<input type="checkbox"/>	<input type="checkbox"/>
19. Overland flow to and from adjoining properties not affected	<input type="checkbox"/>	<input type="checkbox"/>
20. Remedial work required? <input type="checkbox"/> Yes (please list) <input type="checkbox"/> No		

Council

Developer

F5.7 PUMP STATION CONTROL PROGRAMMING CHECKLIST

Pump Station Identity/Location:

Council Representative:

Works Contractor:

Subcontractor(s) if applicable

Date

Station Design Information	Design Measurements	As-Built Measurements
Levels recorded as mRL (Motoriki Datum)		
Lid mRL as measure at top of Lid Cross Brace		
Design mRL for base of Level Transducer		
Design mRL for Wetwell Base		
Analogue Control Levels to be stated in mm from base of wetwell <ul style="list-style-type: none"> • Common Stop Level • Duty A Start Level • Standby Start Level • High Level • Critical Alarm Level • Storage Empty Level • Storage Full Level • Overflow invert Level 		
Design Flow Rate 2 pumps running (L/s)		
Pump designed start up current (Amps)		
Catchment Plan Information		
Downstream Pump Station Upstream Pump Stations		

5.3.12 PLC Programme

PLC Programme Installed:_____.

Council

Developer

All core labels on and correct	
All trunk lids in place and cut burs removed	
Cable ties trimmed	
Box labelling present and correct <ul style="list-style-type: none"> • Meter • Distribution • Controls • Change Over Switch • PLC • Instrumentation 	
Pump labelling present and correct (for each pump) <ul style="list-style-type: none"> • Pump No • Temp • Leakage • Reset 	
Analog ammeters scaled for design pumps	
Switch labelling present and correct <ul style="list-style-type: none"> • Level Control, Light On = Float, Light Off = US, Push Change • Duty Change 	
Cabinet clear of construction debris	
External cabinet door close and locks	
Internal door close and seal	
Locks operate on specific and master keys	

5.3.13 Wiring Trace:

Council

Developer

			CH	Term Block	PASS	
SITE	Phase Fail	I:	0/0			
	Critical Level Alarm	I:	0/5			
	Duty A	I:	0/7			
	Duty B	I:	0/6			
	Common Stop	I:	0/8			
	Fault Reset / Duty Change	I:	0/9			
	Door Tamper	I:	1/0			
	Flow - Pulse	I:	1/13			
	Flow – Instantaneous		IN	3-		
				3+		
	Ultra Sonic Level		IN	0-		
			IN	0+		
	Level Control Change	I:	1/7			
	Battery Low	I:	1/15			
Level Control Indicator	O:	0/2				
Wash Solenoid	O:	0/3				
Pump 1	Run	I:	0/1			
	Fault	I:	0/2			
	MiniCas	I:	1/1			
	Auto	I:	1/3			
	Manual	I:	1/5			
	Start	O:	0/0			
	CT	IN	1+			
Pump 2	Run	I:	0/3			
	Fault	I:	0/4			
	MiniCas	I:	1/2			
	Auto	I:	1/4			
	Manual	I:	1/6			
	Start	O:	0/1			
	CT	IN	2+			

This form is intended to ensure that the station meets design requirements for the successful ongoing operation of the Wastewater Pumping Station.

Council Representative:

Works Contractor:

Subcontractor(s) if applicable

.....

.....

.....

5.3.14 Level Monitoring Systems

Installation Level Confirmation:

Council

Developer

Parameter	Survey Levels as mRL (Motoriki Datum)
Lid as measure at top of Lid Cross Brace	
Base of Level Transducer	
Storage Invert	
Storage Obvert	
Critical Level invert	

Where installed levels differ from the design set-up and cannot be rectified then changes in the station's programmed level controls system need to occur.

5.3.15 Level Control Checks

Council

Developer

Near Blanking Distance Clearance Check

Ensure that the differential between base of Ultrasonic Level Transducer and obvert of the Overflow pipe must be >0.35m

NOTE: The near blanking distance above is valid only for the standard Pulsar DB6, where, the wetwell depth requires alternative types then the near blanking distance will differ and needs to be catered for in the design of the station level monitoring system.

Ultrasonic Near Blanking Clearance Confirmation

	Parameter		
A.	Base of Level Transducer	mRL	
B.	Critical Alarm Level	mRL	
C.	Overflow Diameter	m	
	Overflow/Transducer differential (= A – B – C)	m	
	Pass (> 0.35m)	Y/N	

5.3.16 Analogue Monitoring Performance Checks

Council

Developer

Analogue level accuracy check is to occur throughout the operational level span for the station.

The station’s level monitoring must meet validated measurements with the greater of +/- 10mm or 1% of operational span. Therefore station monitoring error = (validated measurement – station measurement).

Approximate Position	Validation Measurement (mm)	Station Level Measurement (mm)	Measurement Differential (mm)	Measurement Error (% of Span)	Pass (Y/N)
Common Stop Level					
High Level					
Overflow					

NOTE: due to Analogue display dampening the well must be maintained at a static level for 120 second before readings are taken.

5.3.17 Float Installation Check.

Council

Developer

The Flygt ENM-10 operates about the tipping point at the top of the float, all measurements for setting and validation of installation are made from point A as shown below to the top of the lid cross brace.

Flygt ENM Float and Level Setting

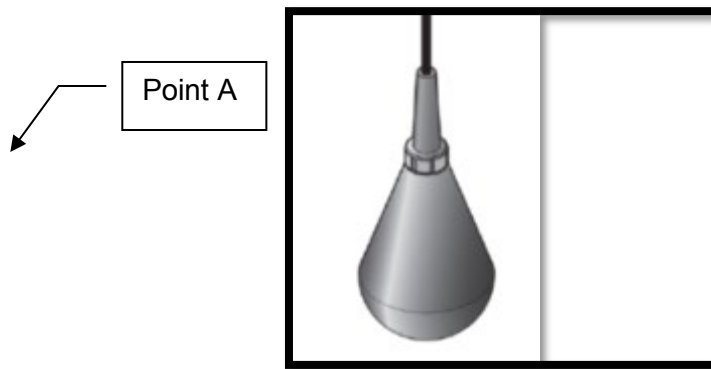

Float	Distance to Lid (m)	Distance to Base (m)	U/S reading at activation (m)	Flat State Confirmation
Critical Alarm				<input type="checkbox"/> NC
Duty B Start				<input type="checkbox"/> NO
Duty A Start				<input type="checkbox"/> NO
Common Stop				<input type="checkbox"/> NO

5.3.18 MiniCas Supervision Relay Check

Council

Developer

Confirm that the sensors within the pumps are connected correctly to the appropriate MiniCas unit.

P1			
P2			

5.3.19 Pump Information Sheet

Council _____

Developer _____

Nameplate Data Collection for each pump record the following information for each pump as shown on the right:

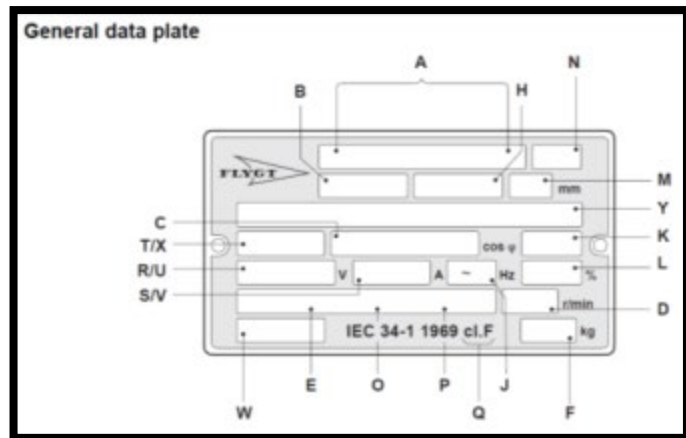

Parameter	P1	P2
A Product No.		
B Serial No.		
C Shaft power		
D Rated speed		
E		
F Weight		
H Curve code		
J		
K Power factor		
L Operating duty, cont./int.		
M Impeller.		
N Factory code		
O	N/A	N/A
P	N/A	N/A
Q Temperature class		
R/U Rated voltage		
S/V Rated current		
T/X Stator connection		
W Special order No.		
Y Motor No.		

5.3.20 Pump Performance Checks

Council

Developer



Before starting Pump Pre-commission Inspection

- **Make sure that the pump is isolated from the power supply and cannot be energized.**
- **Make sure that the pump cannot roll or fall over and injure people or damage property.**

- Pump is isolated from electrical supply
- Check that the visible parts on the pump and installation are undamaged and in good condition, including cables.
- Check the oil level in the oil housing.
- Open the circuit breaker and check that the impeller can be rotated freely.

This is an important step to free mechanical seals prior to electrically starting the pumps to avoid potential damage to the pump.

Check that the Impellor clearance is within tolerance (<1.5mm).

- P1
- P2

On completion and passing of pump static tests the pumps can now be temporarily livened to test direction rotation.

5.3.21 Pump Rotation Test

Council

Developer

Check the direction of rotation. The impeller shall rotate clockwise, as viewed from above. When started, the pump will jerk in the opposite direction to the direction in which the impeller rotates.

Mains Power

- P1
- P2

Generator Power

- P1
- P2

On successful completion of rotation tests, re-isolate pumps and inspect guide rail system prior to installing pumps onto their respective pedestals in preparation for pump performance test.

- Pump is isolated from electrical supply
- Check Upper Guide Rail brackets are secured to well structure
- Check that guide rails align vertically between discharge bend and upper guide brackets
- Check that the pump lifting handle is secured to pump.
- Check that a lifting chain is secured to the pump lifting handle with sufficient length and that the D-shackle pin is secured with stainless wire to prevent damage to the pump.
- Check that the lifting chains are secured at the lids and are free of slack to prevent damage to pumps.
- Check that the Pump cables are secured and free of slack to prevent damage from pump operation

5.3.22 Pump Current Draw

Council Developer

	Start-Up Reading	10 Seconds Post Start	@ 10 seconds post Snore
Clamp on Meter			
Stations CT			
Station's Analogue Meter			

5.3.23 Pump Riser Tests

Council Developer

- Fill the wet well with water to the invert level of the incoming sewer
- With the relevant gate valve open, start one pump in manual mode and check for leaks, pump/motor vibration or noise, and that the well level drops
- Shut gate valve and restart pump and check for any leaks in pipework or at the discharge bend connection

5.3.24 Setting Pump Overload

Council Developer

The pump overload is to be set by an Electrician at the time of the commissioning of the cabinet onsite. This should be set as per the overload settings specified for the pump by the pump manufacturer and as recorded on the pump name plate.

5.3.25 Pump Pressure Head Measurement

Council Developer

P2 _____
P1 & P2 _____

F5.8 VERIFICATION OF FLOW METER DRAW DOWN TEST

Council

Developer

- All measurements to be made from lid down
- Wet well is “bagged” off from upstream network
- Ensure pumps remain fully submerged throughout test
- Level change $0.3m > Draw (b-a) < 0.5m$

	Pump 1	Pump 2	Combined
Start (m) “a”			
Stop (m) “b”			
Well ø “c”			
Vol Change			
Run Duration			
Calculated Flow			
Measure totaliser			
Volume Change			
Calculated – Measure Differential % ¹			
Design Flows			
Design % Differential ²			

1

2 Design differential = (design – measured) / design

DRAWINGS

Table 5-17 : Drawing Register

DRAWING NO.	TITLE
D5.1	<u>1050 dia. to 1350 dia. Manholes</u>
D5.2	<u>Typical Dimensions for Manholes Greater than 1350 dia.</u>
D5.3	<u>Shallow Manholes</u>
D5.4	<u>Lateral Connection</u>
D5.5	<u>Anti-Scour Blocks</u>
D5.6	<u>Building Over and Adjacent Pipelines</u>
D5.7	<u>Wastewater Pumping Station Site Plan Layout</u>
D5.8	<u>Wastewater Pumping Station – Cross Section</u>
D5.9	<u>Standard Wastewater Pumping Station For Flygt 3085, 3102 and 3127 Pumps</u>
D5.10	<u>Wastewater Pump Station Upper Section</u>
D5.11	<u>Wastewater Pump Station Lid Frame</u>
D5.12	<u>Wastewater Pump Station Lid Frame Detail 1</u>
D5.13	<u>Wastewater Pump Station Lid Frame Detail 2</u>
D5.14	<u>Wastewater Pump Station Lid Details</u>
D5.15	<u>Wastewater Pump Station Wet Well Secondary Lids</u>
D5.16	<u>Wastewater Pump Station Storage Plan</u>
D5.17	<u>Wastewater Pump Station Storage Section</u>
D5.18	<u>Wastewater Pump Station Storage End Elevation and Details</u>
D5.19	<u>Wastewater Pump Station Flow Meter and Control Cabinet Plinth</u>
D5.20	<u>Wastewater Pump Station Backflow Prevention</u>
D5.21	<u>Wastewater Pump Station Backflow Prevention Cage</u>
D5.22	<u>Wastewater Connections Layout</u>

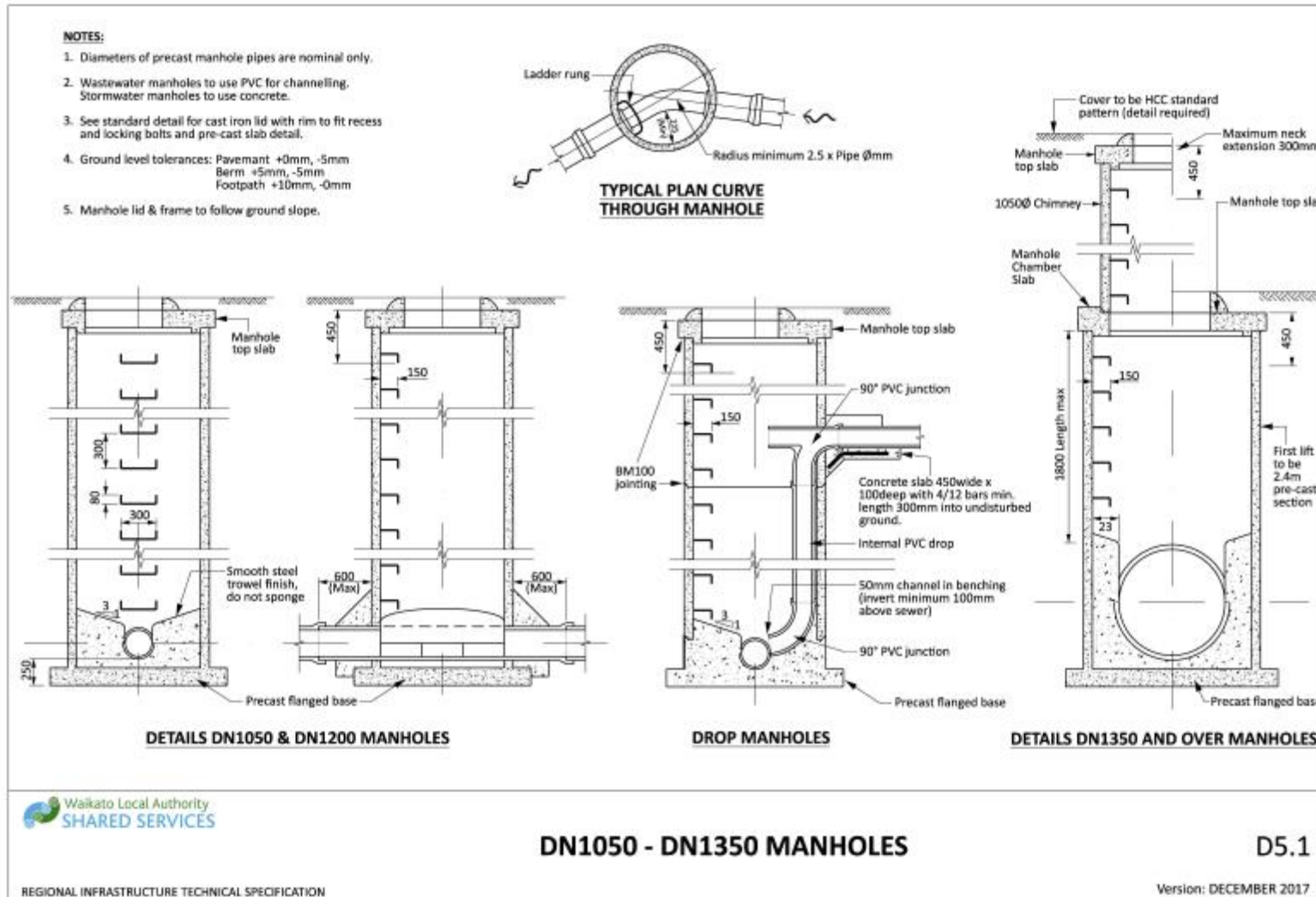

Drawing 5-1: DN1050 - DN1350 manholes

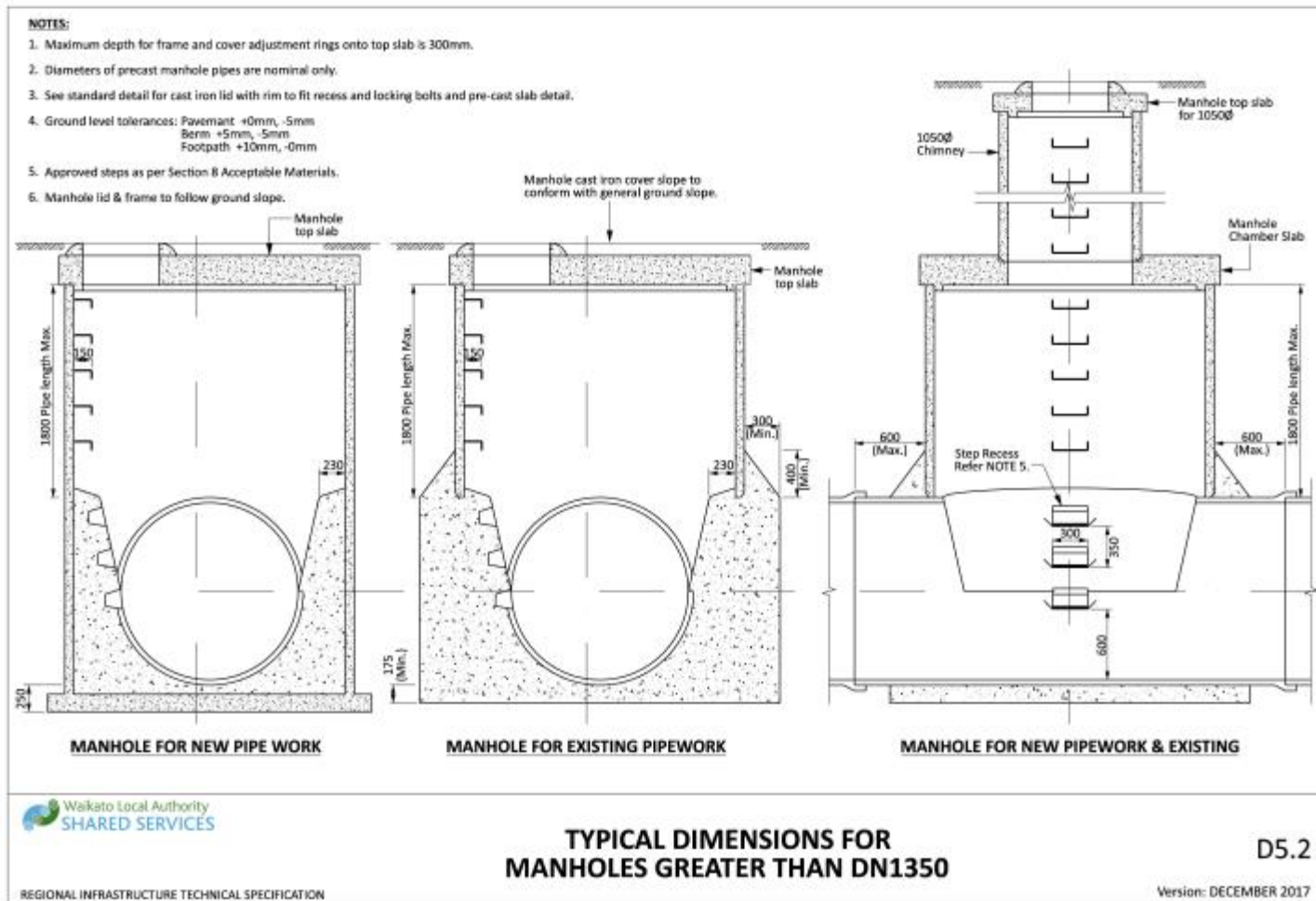

Drawing 5-2: Typical dimensions for manholes greater than DN1350

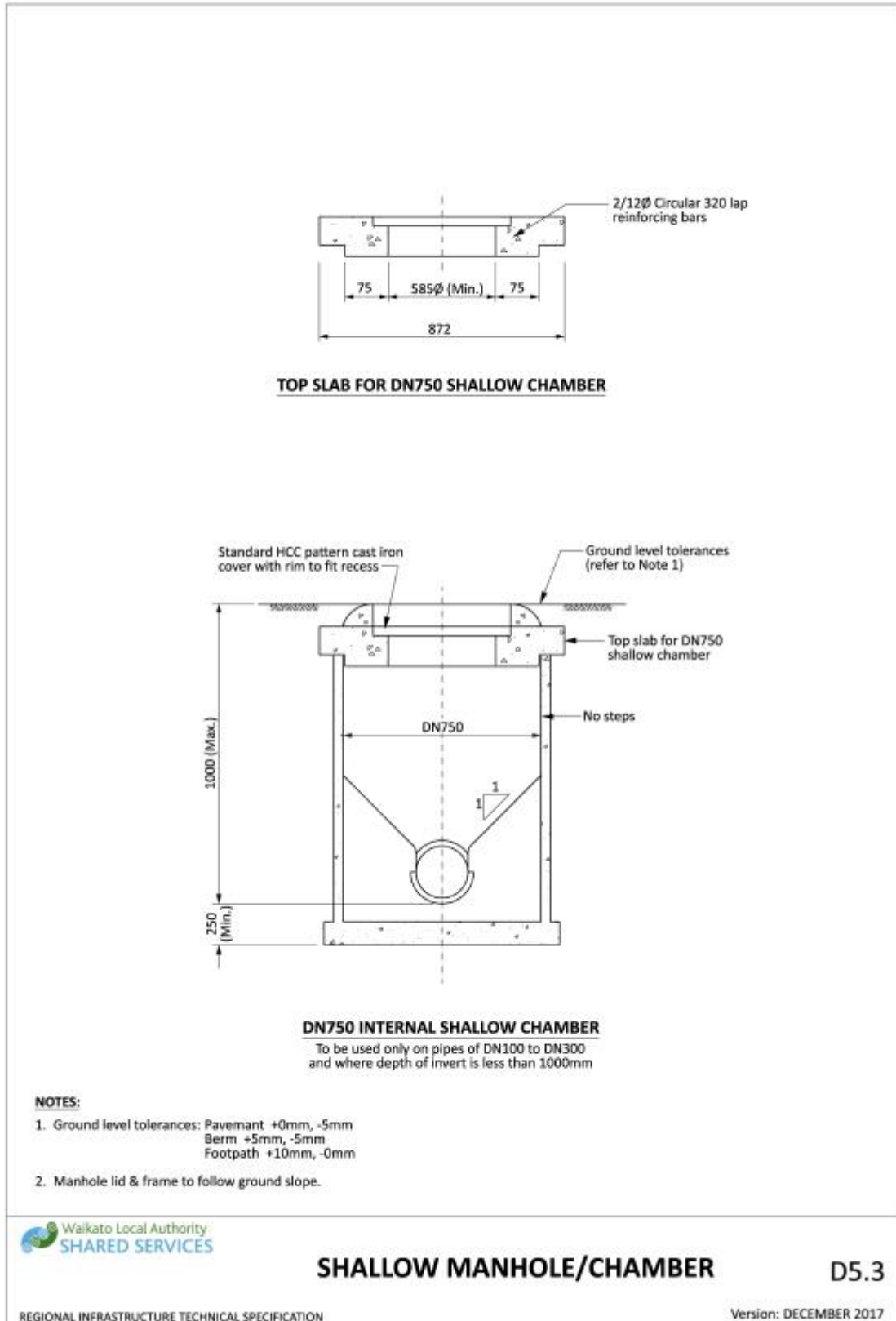

Drawing 5-3: Shallow manhole/chamber

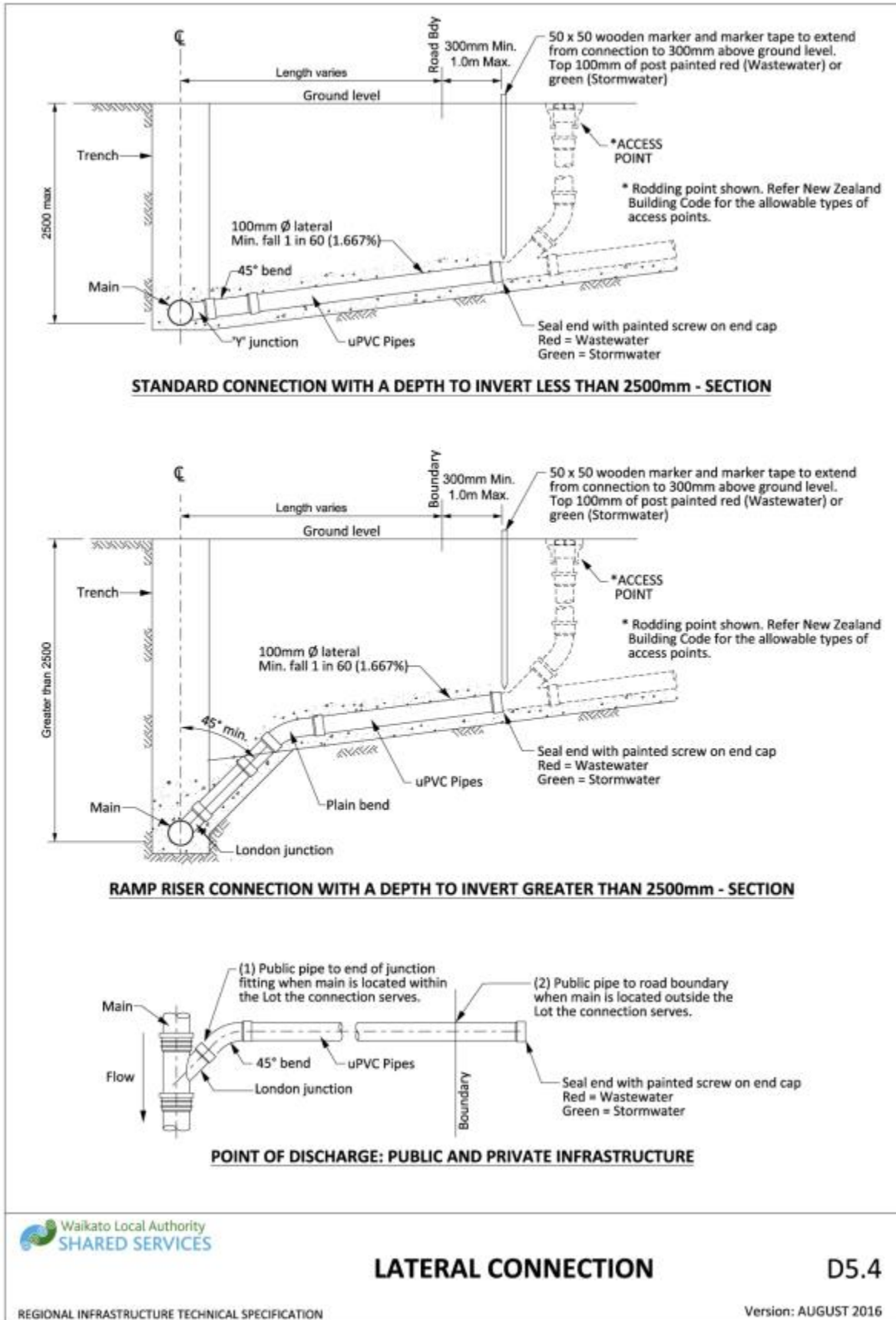

Drawing 5-4: Lateral connection

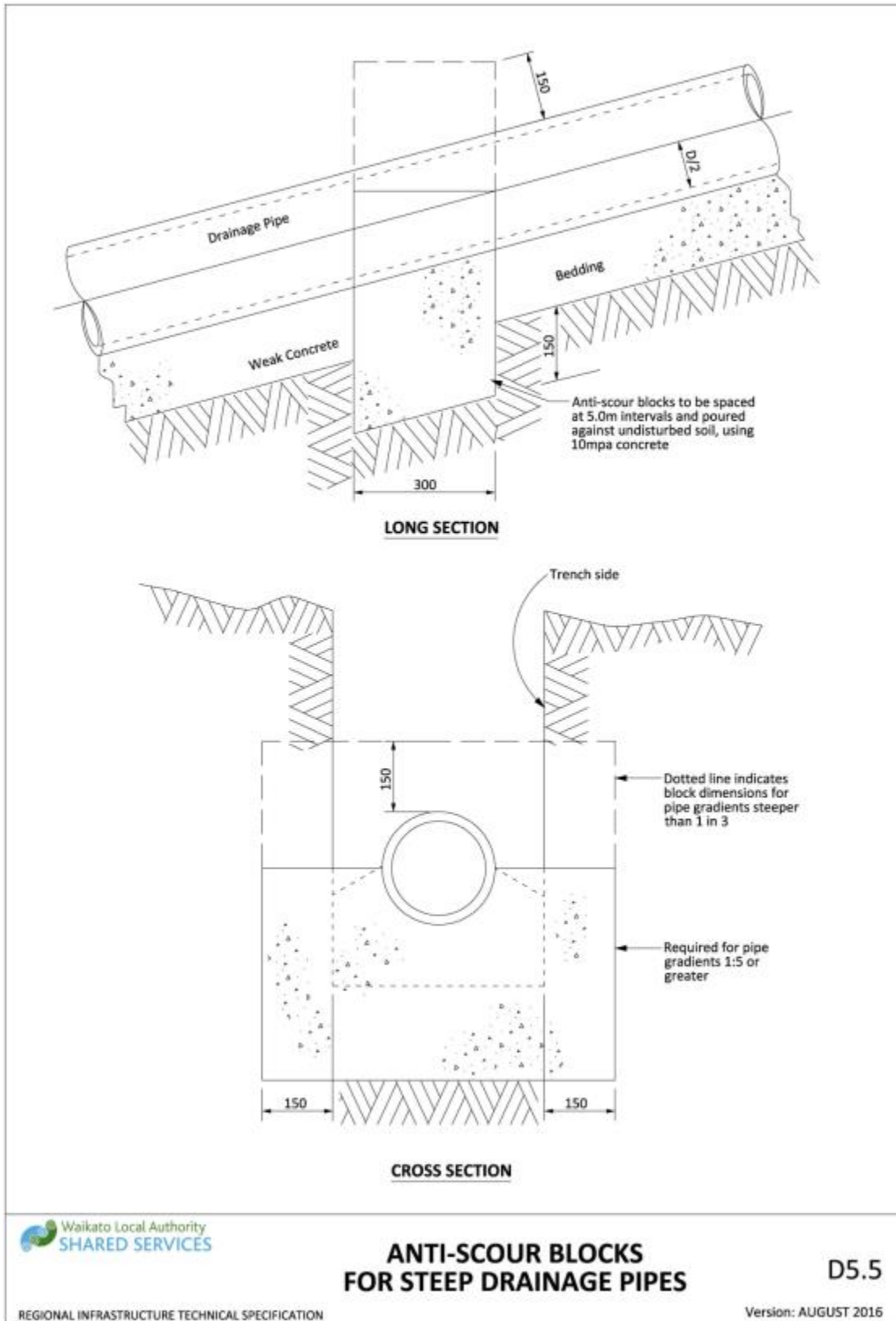

Drawing 5-5: Anti-scour blocks for steep drainage pipes

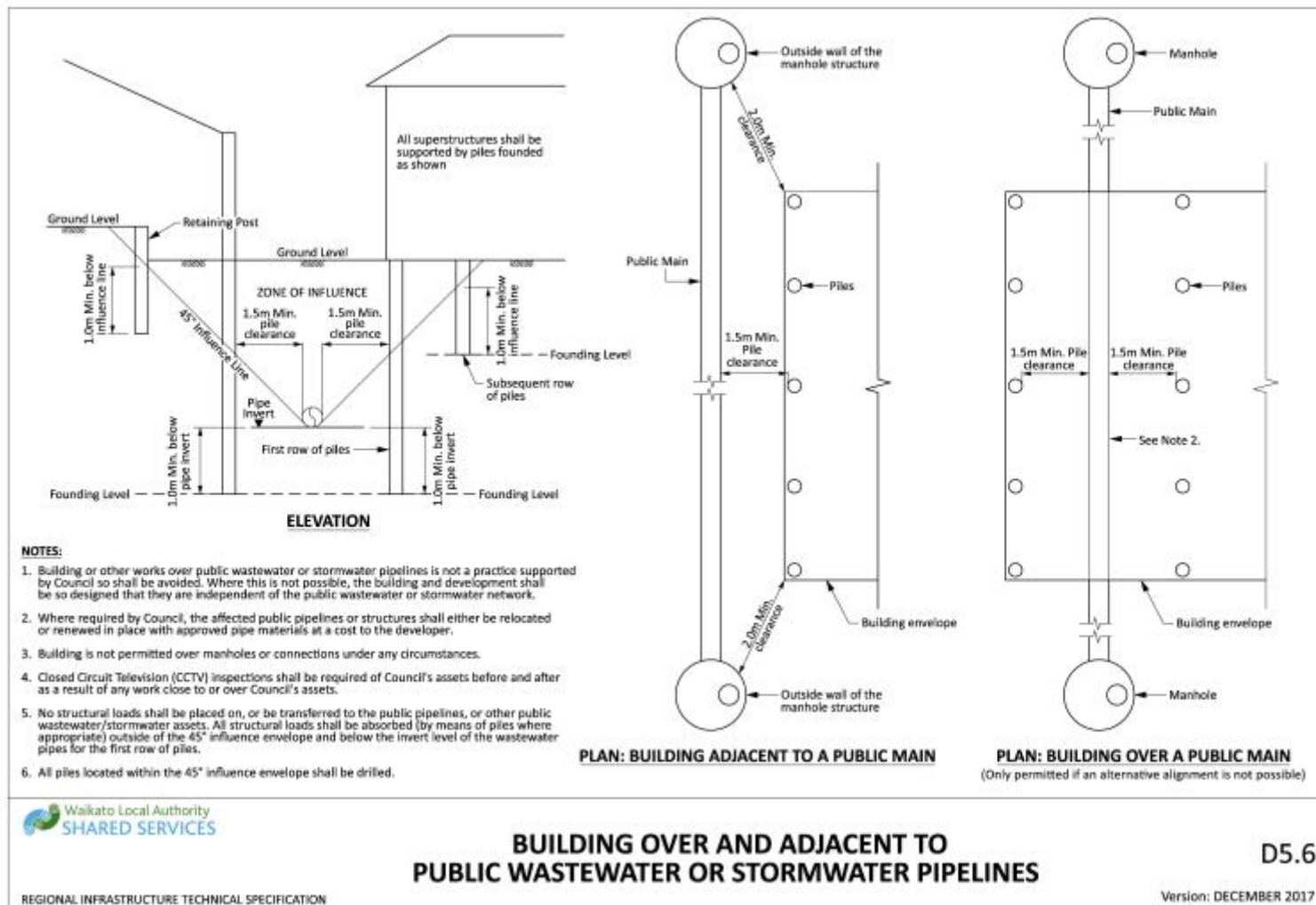

Drawing 5-6: Building over and adjacent to public wastewater or stormwater pipelines

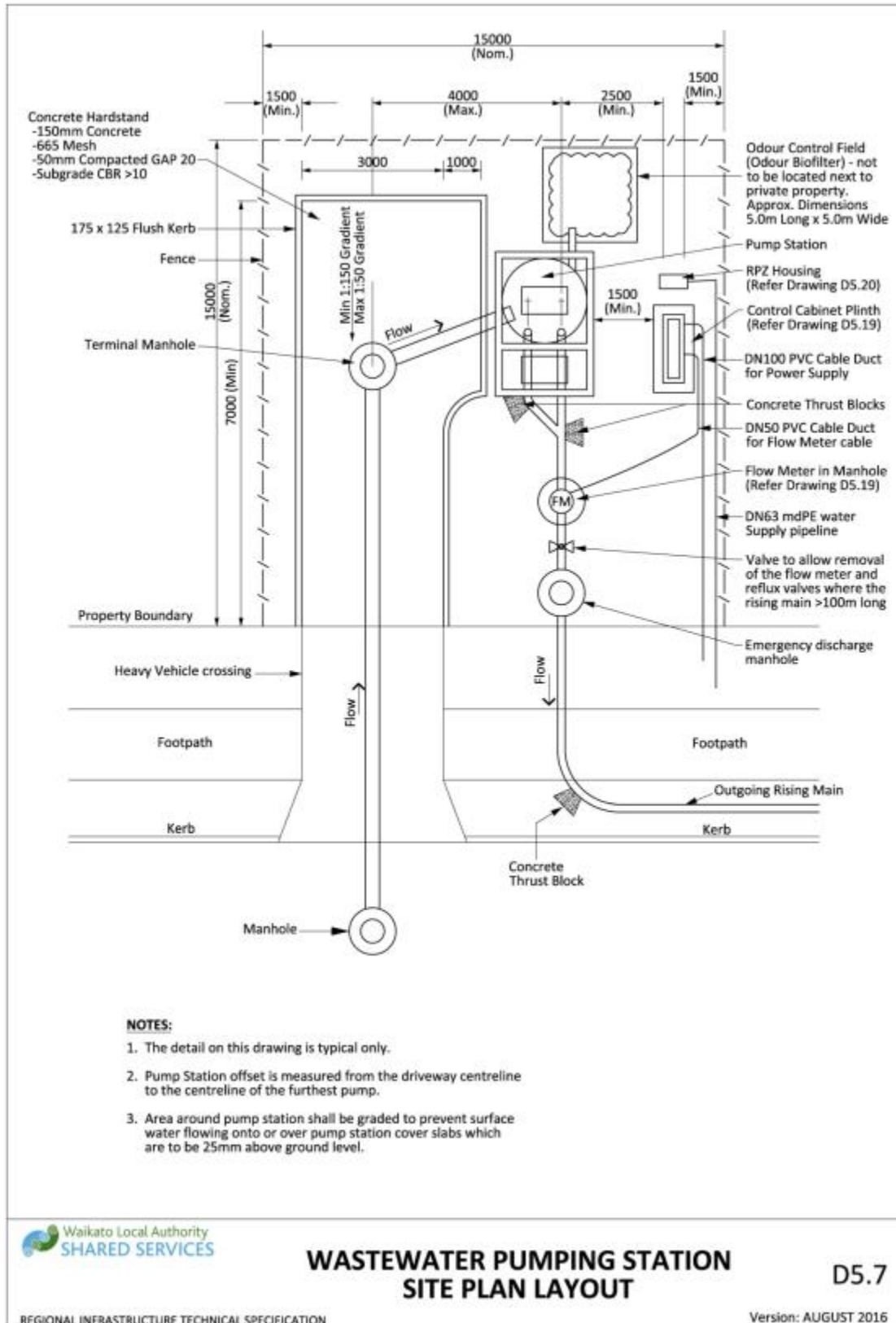

Drawing 5-7: Wastewater pumping station site plan layout

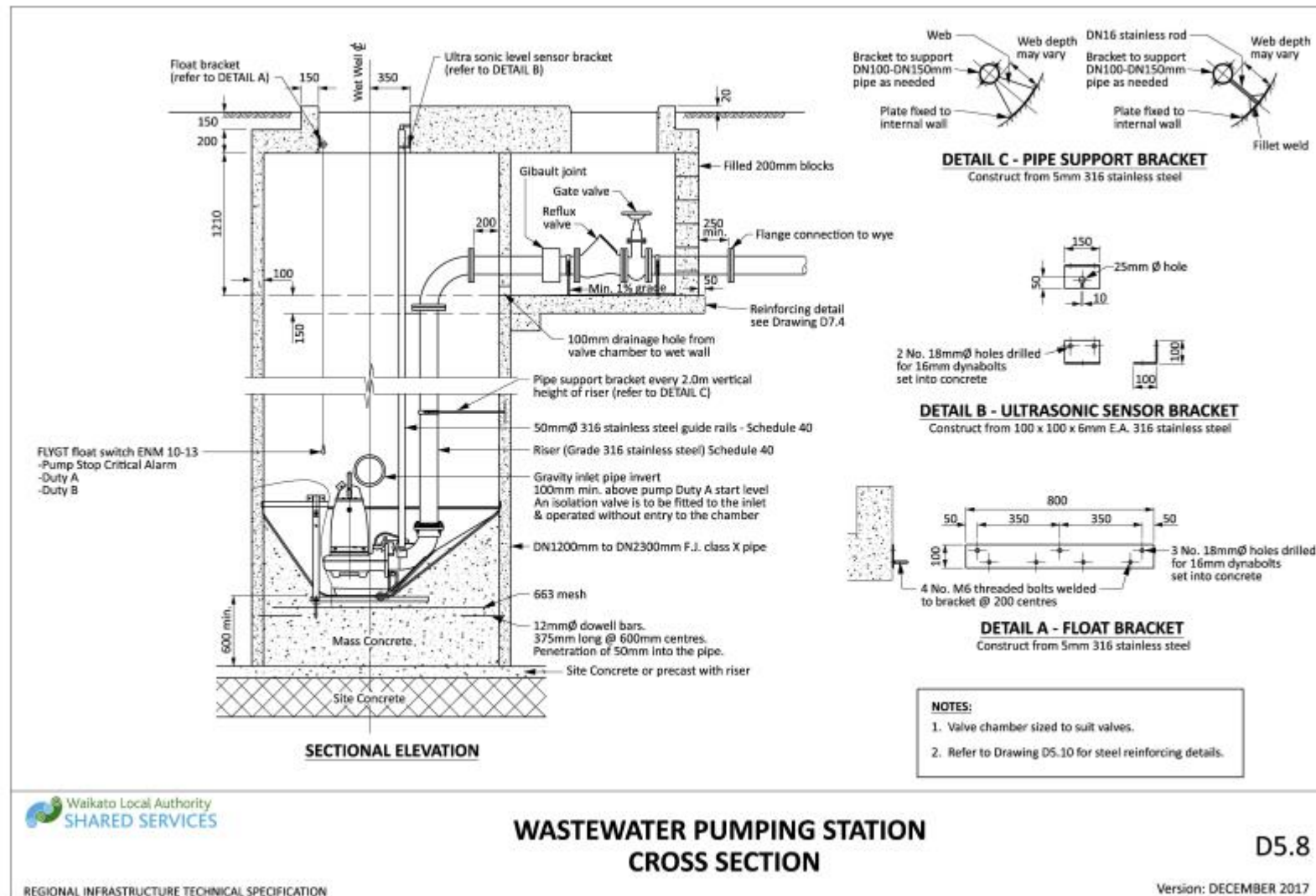

Drawing 5-8: Wastewater pumping station cross section

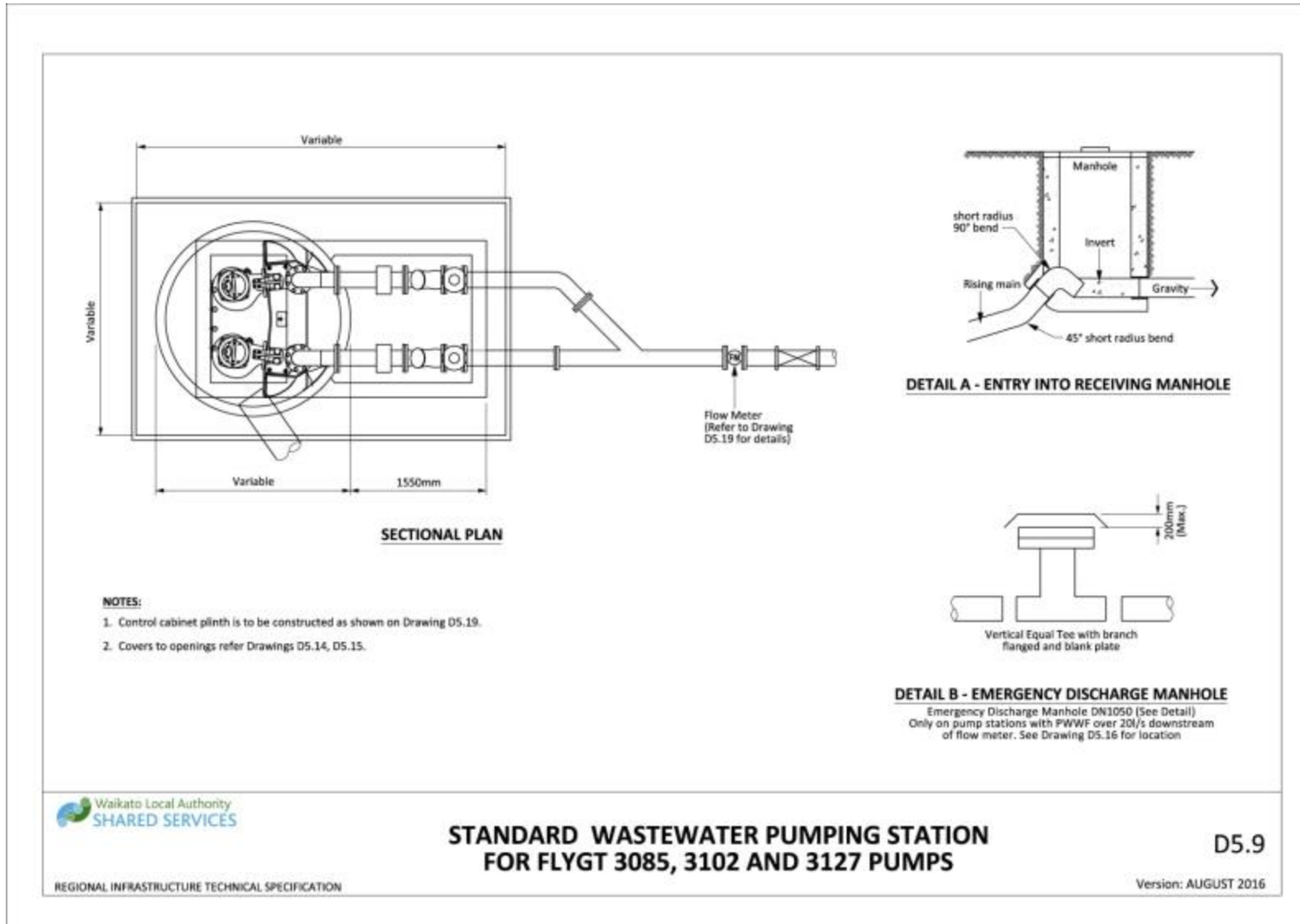

Drawing 5-9: Standard wastewater pumping station for Flygt 3085, 3102 and 3127 pumps

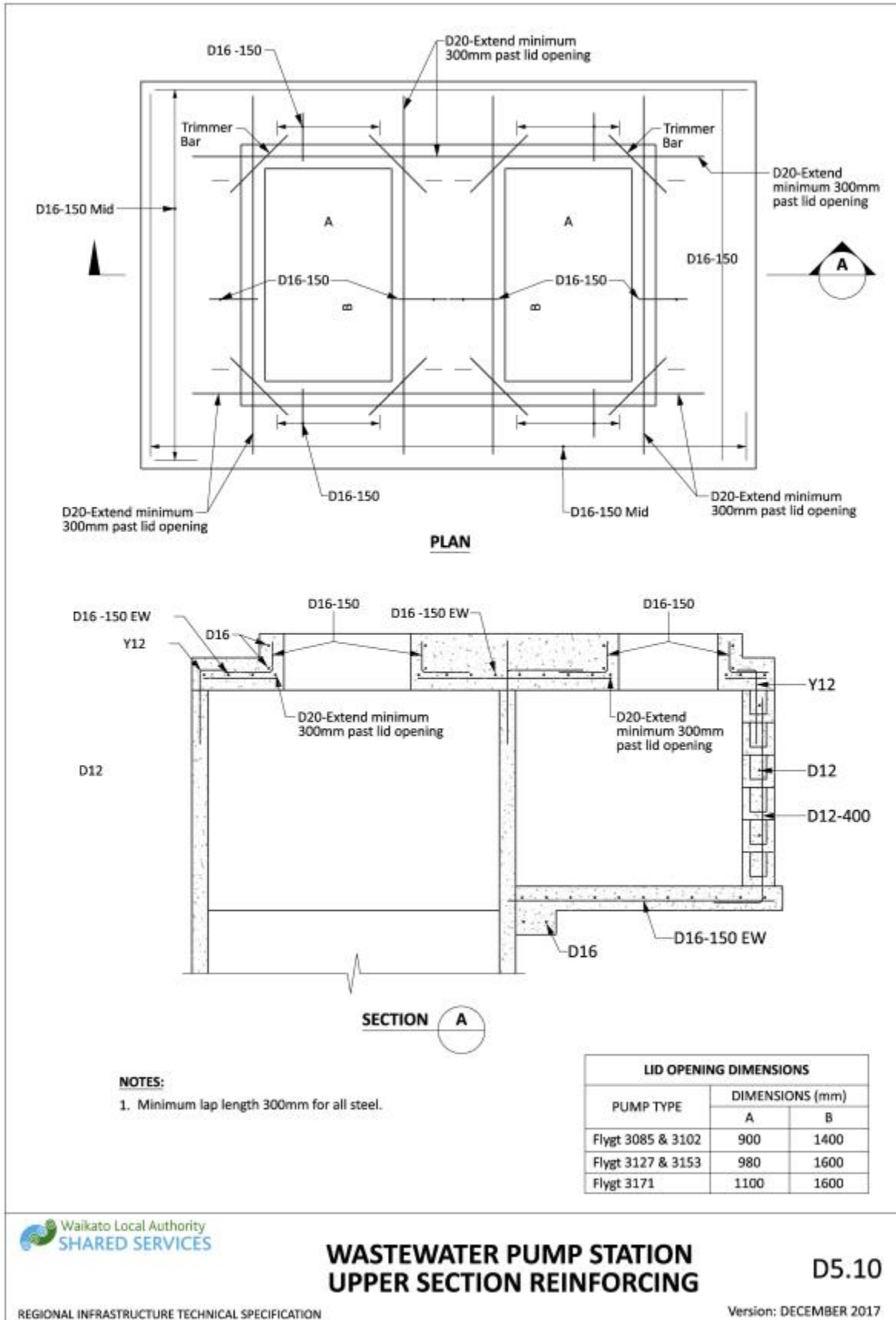

**WASTEWATER PUMP STATION
UPPER SECTION REINFORCING**

D5.10

REGIONAL INFRASTRUCTURE TECHNICAL SPECIFICATION

Version: DECEMBER 2017

Drawing 5-10: Wastewater pump station upper section reinforcing

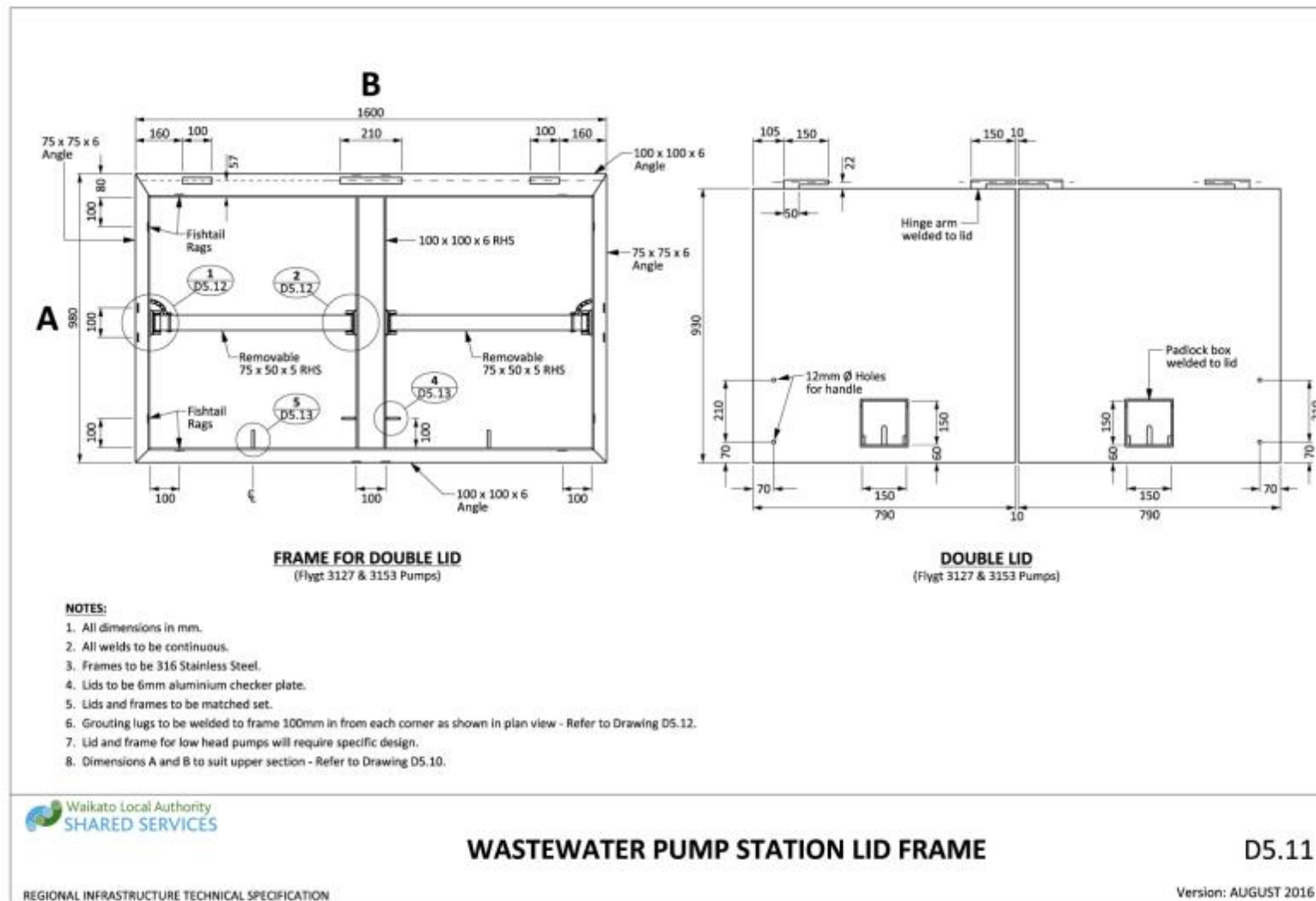

Drawing 5-11: Wastewater pump station lid frame

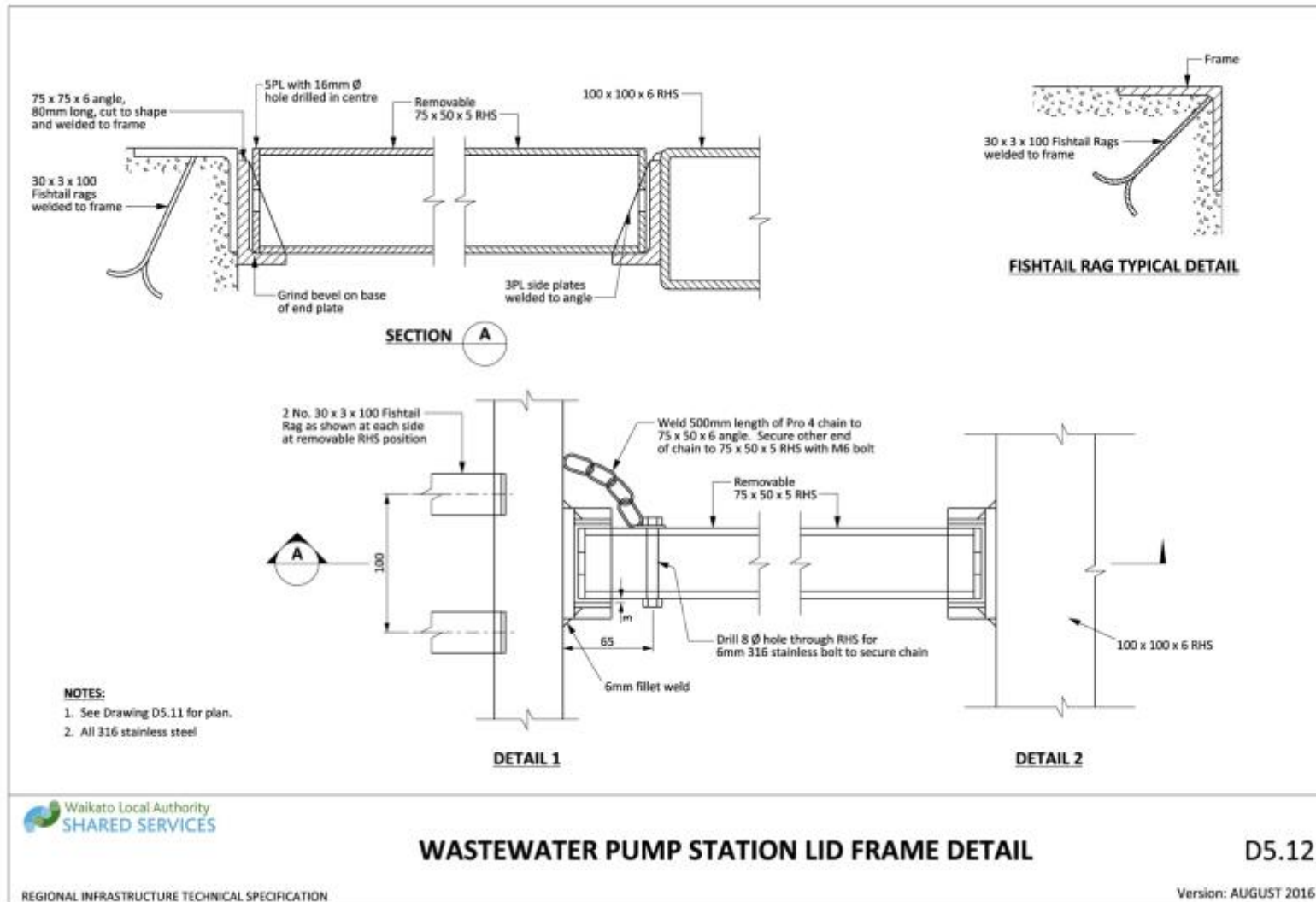

Drawing 5-12: Wastewater pump station lid frame detail

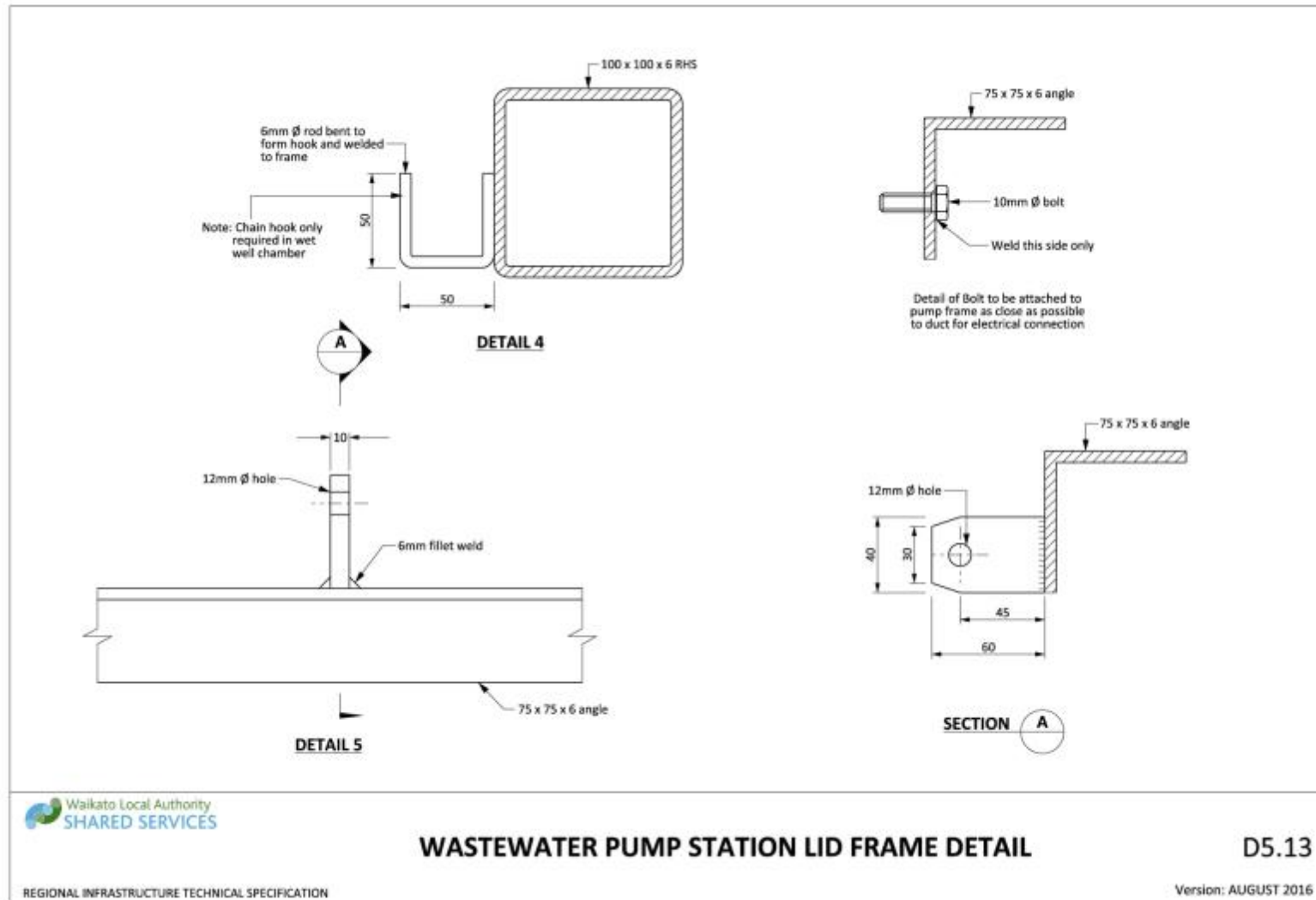

Drawing 5-13: Wastewater pump station lid frame detail

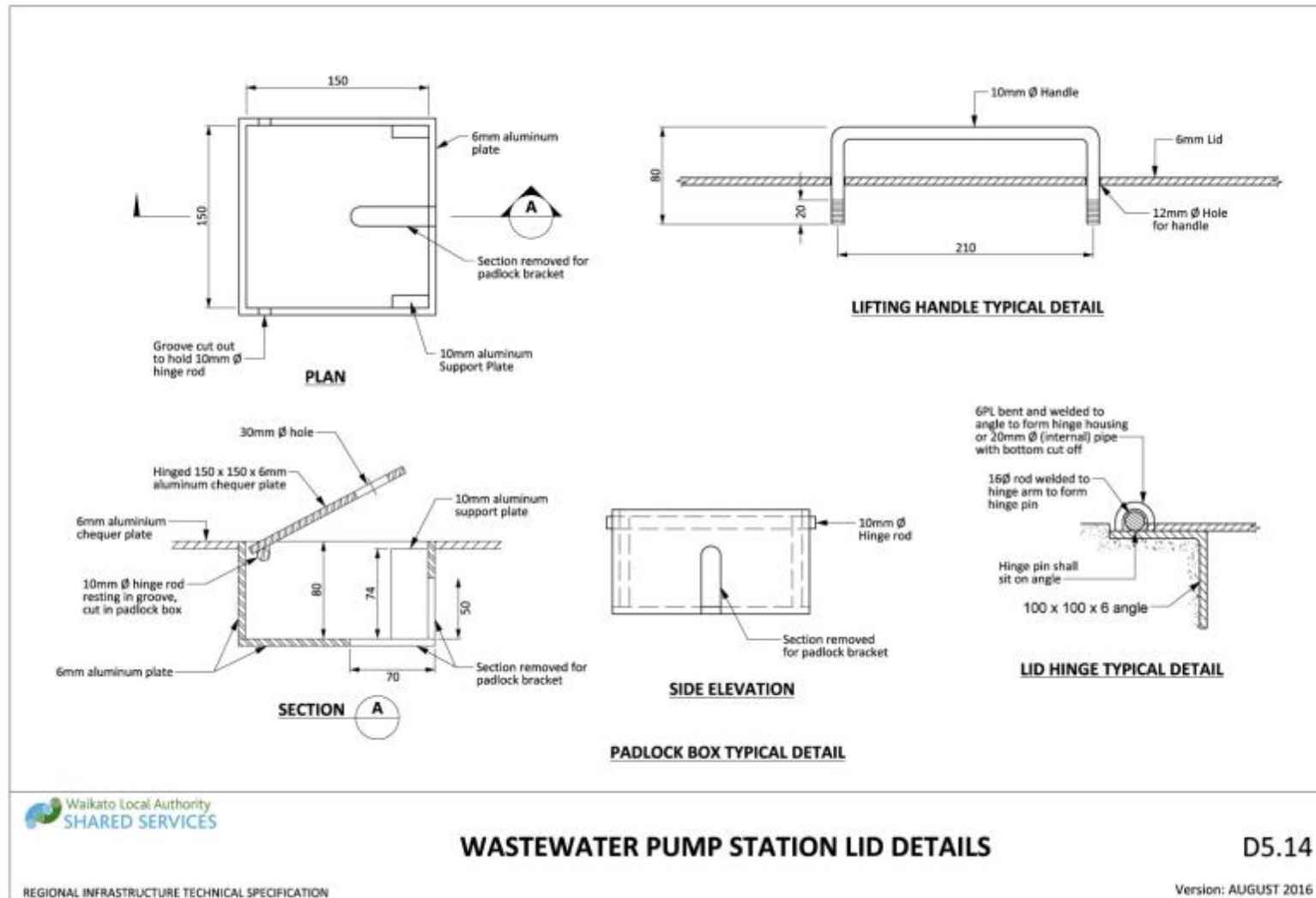

Drawing 5-14: Wastewater pump station lid details

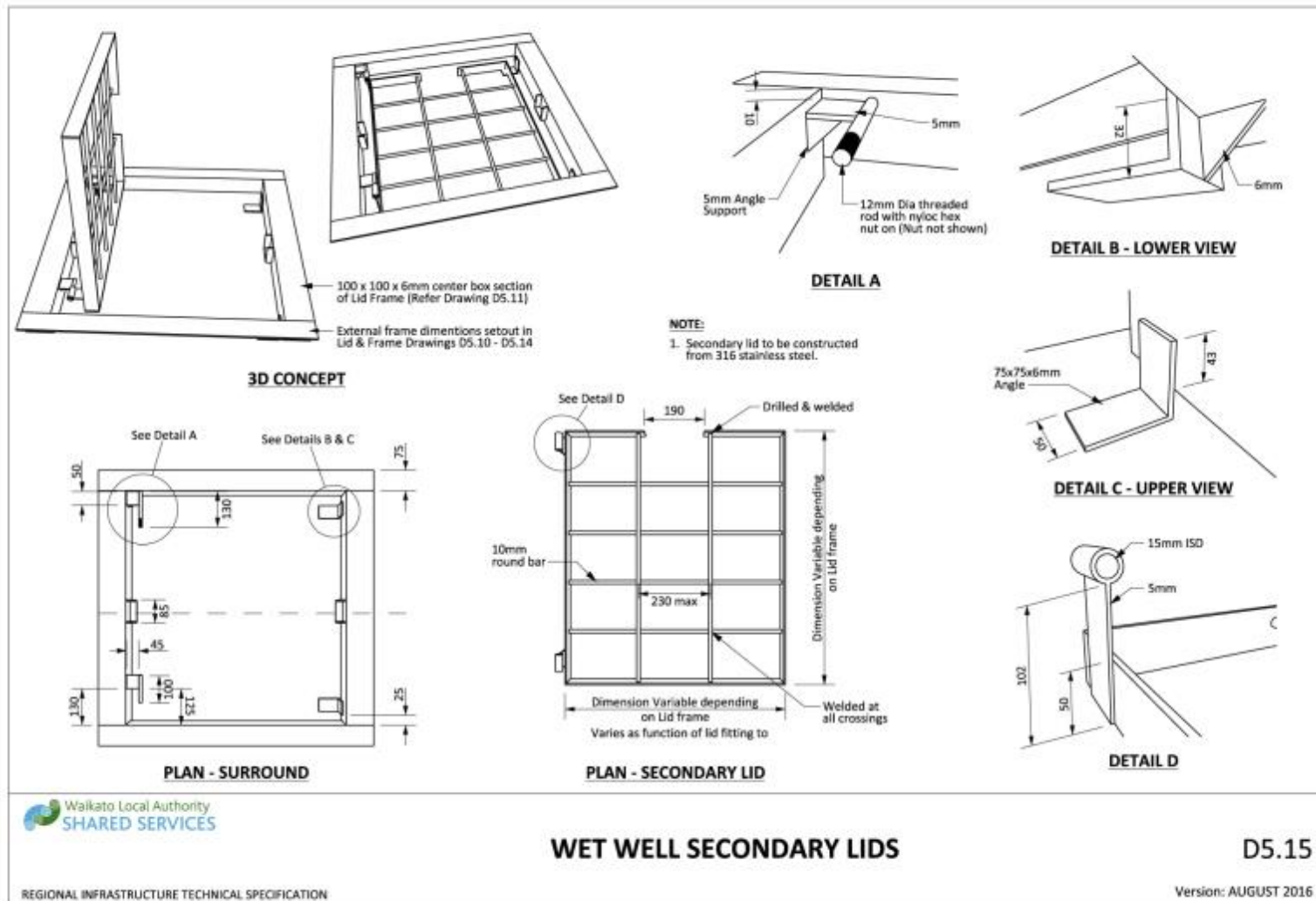

Drawing 5-15: Wet well secondary lids

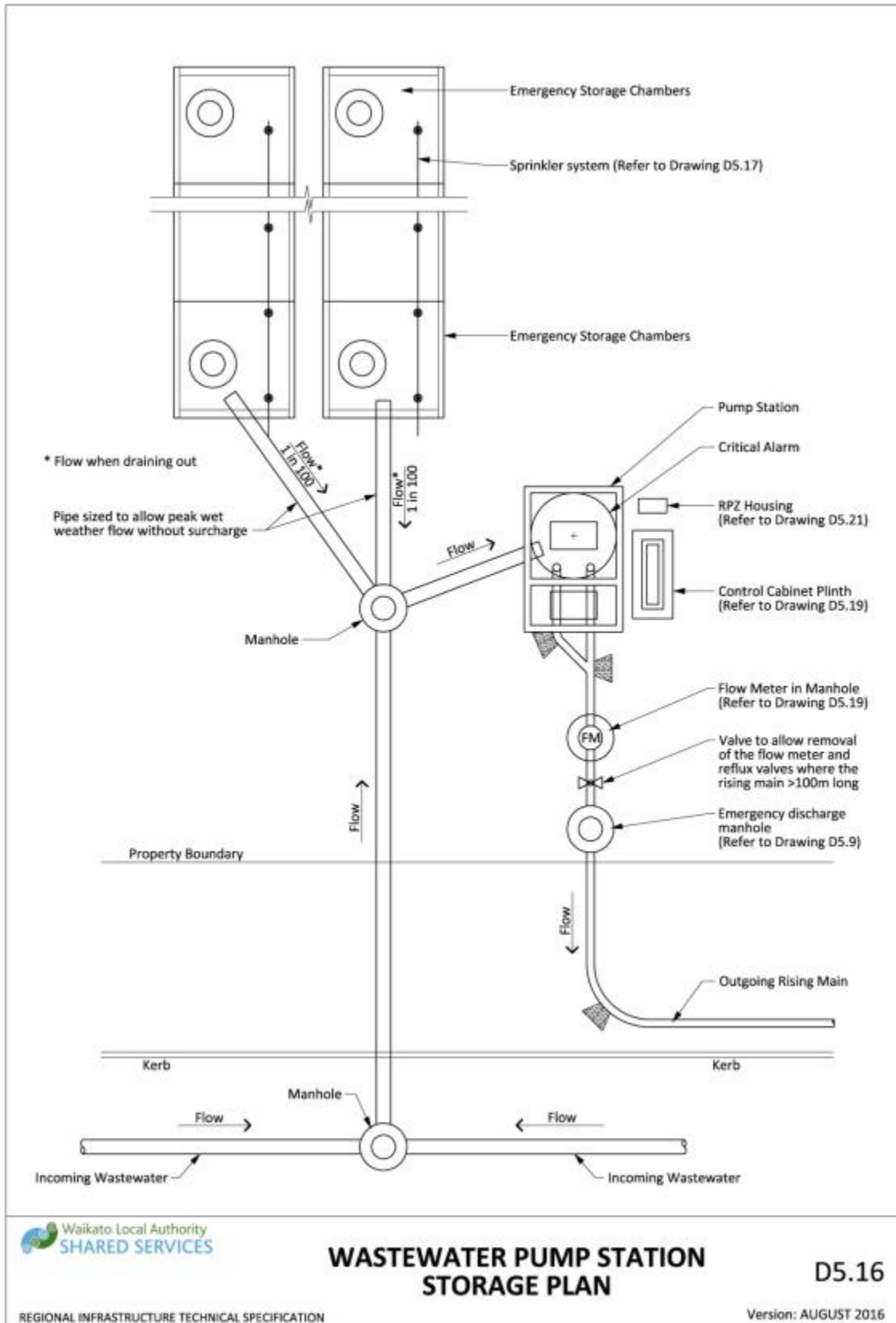

Drawing 5-16: Wastewater pump station storage plan

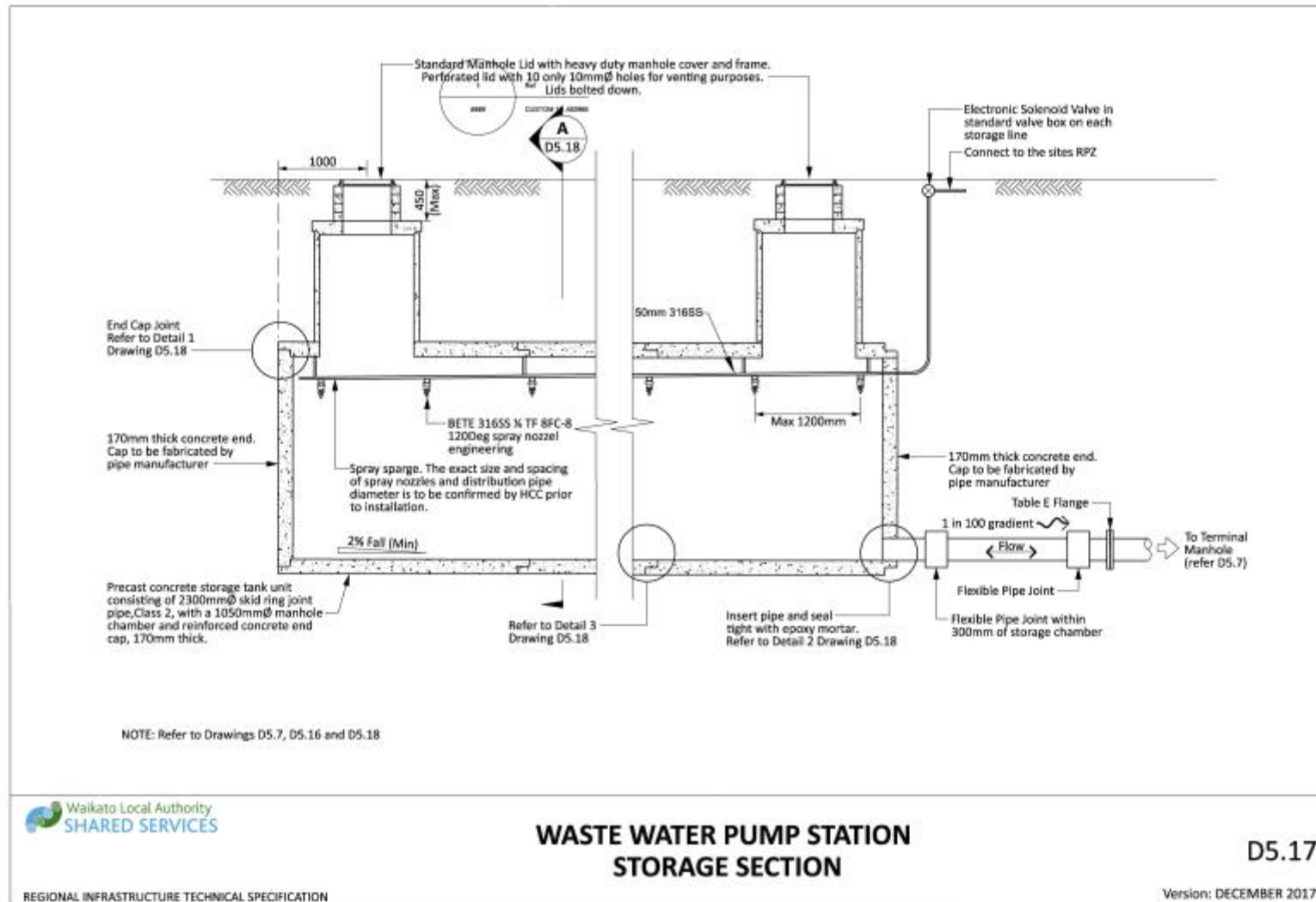

Drawing 5-17: Wastewater pump station storage section

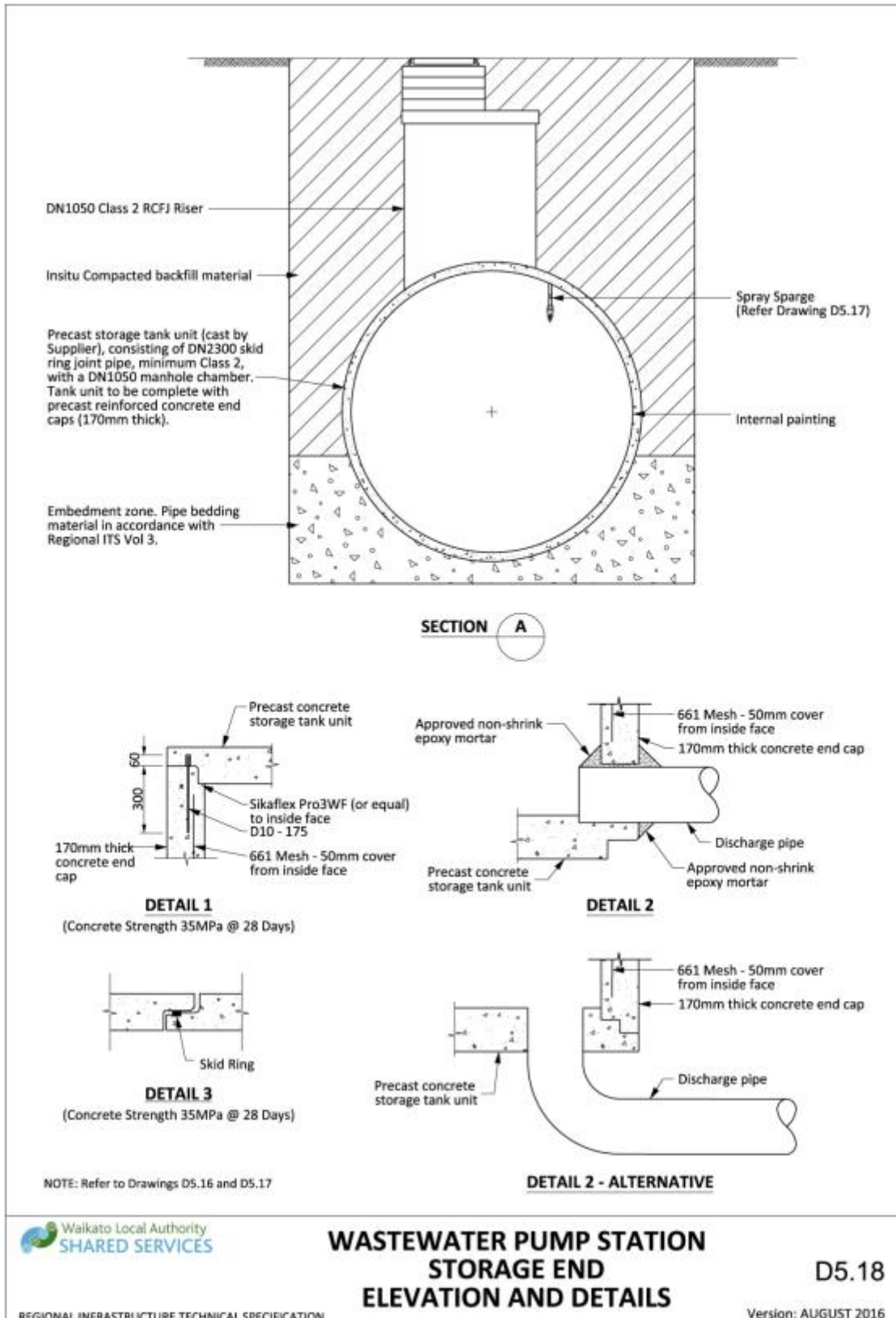

Drawing 5-18: Wastewater pump station storage end elevation and details

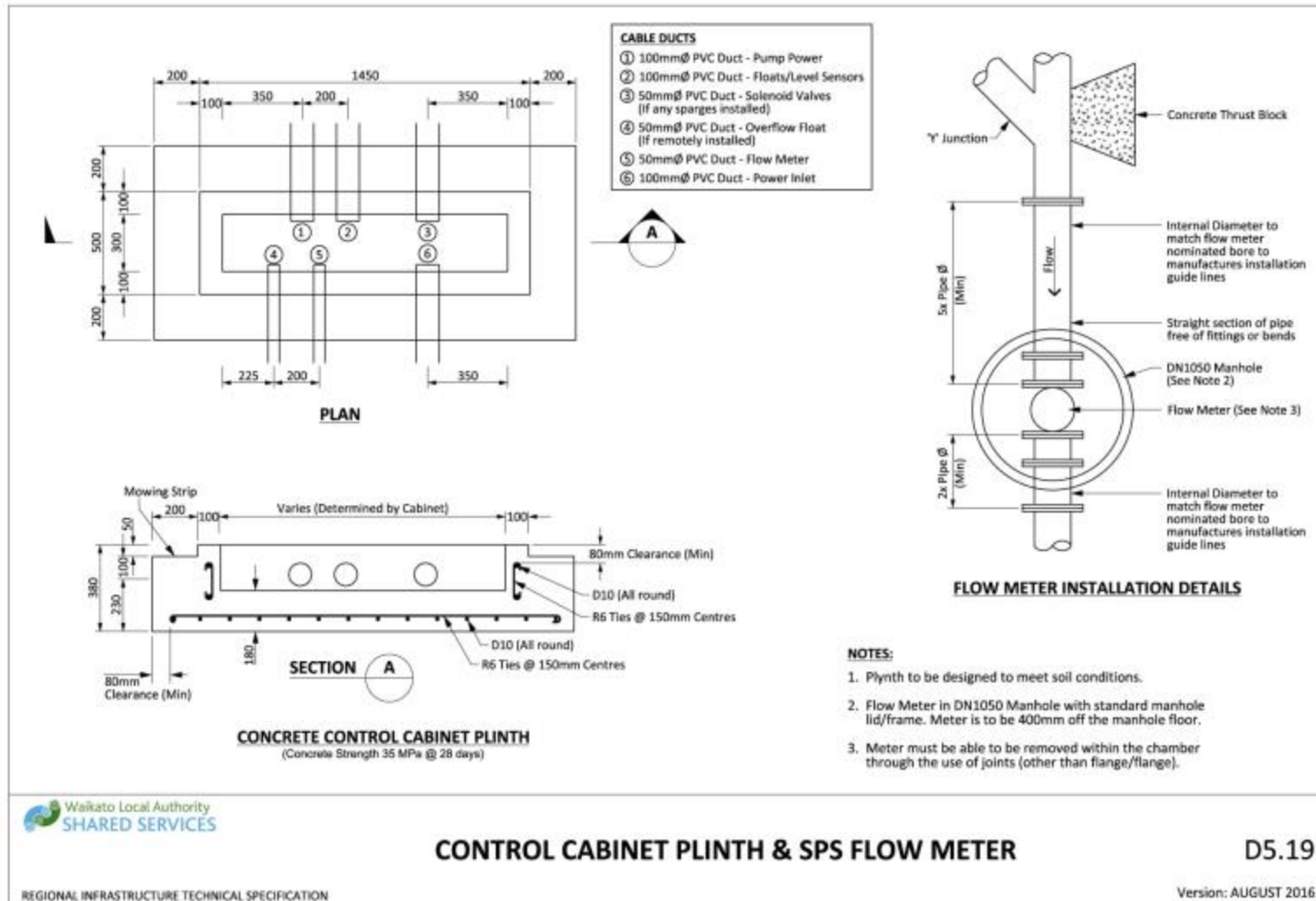

Drawing 5-19: Control cabinet plinth and SPS flow meter

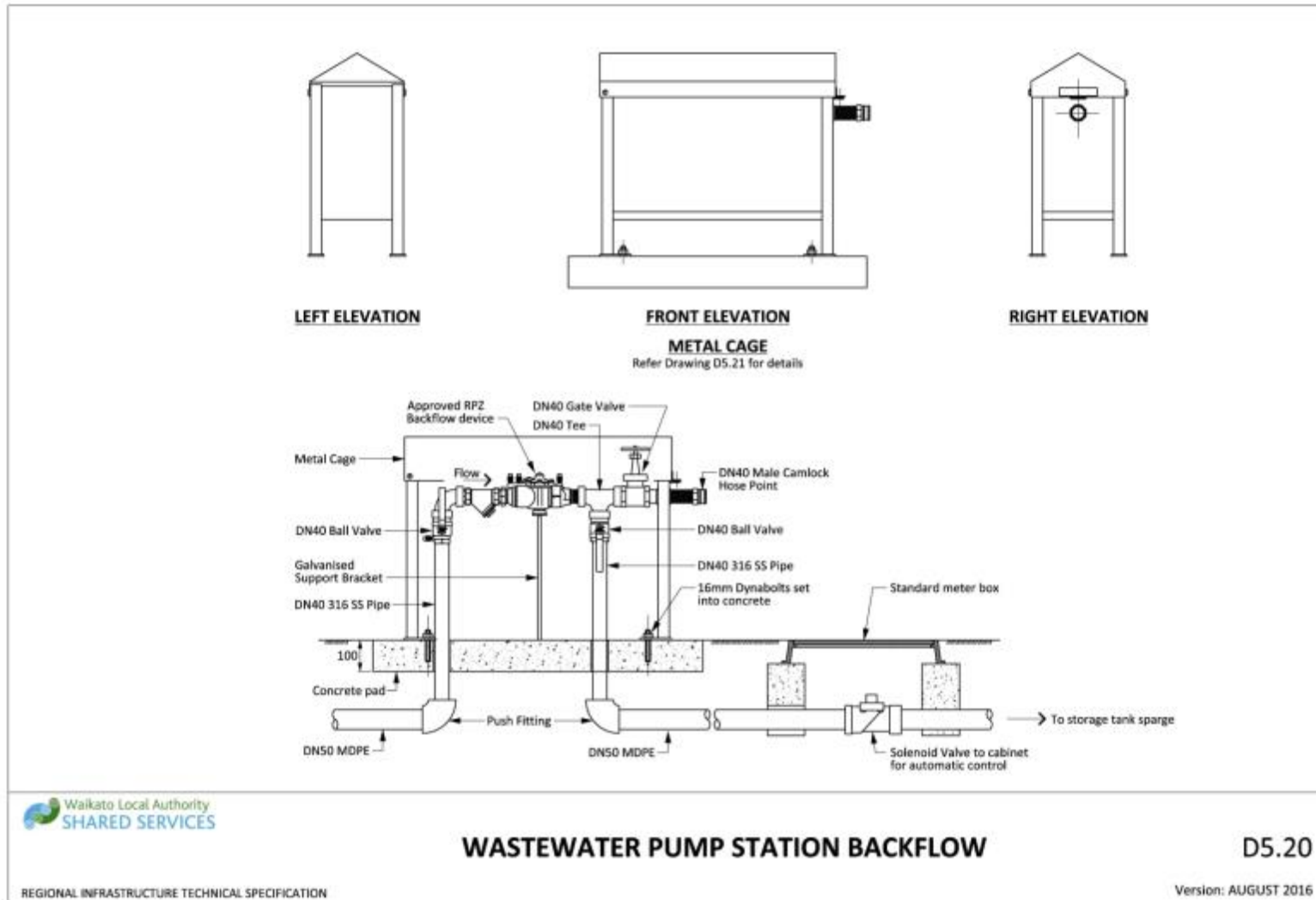

Drawing 5-20: Wastewater pump station backflow

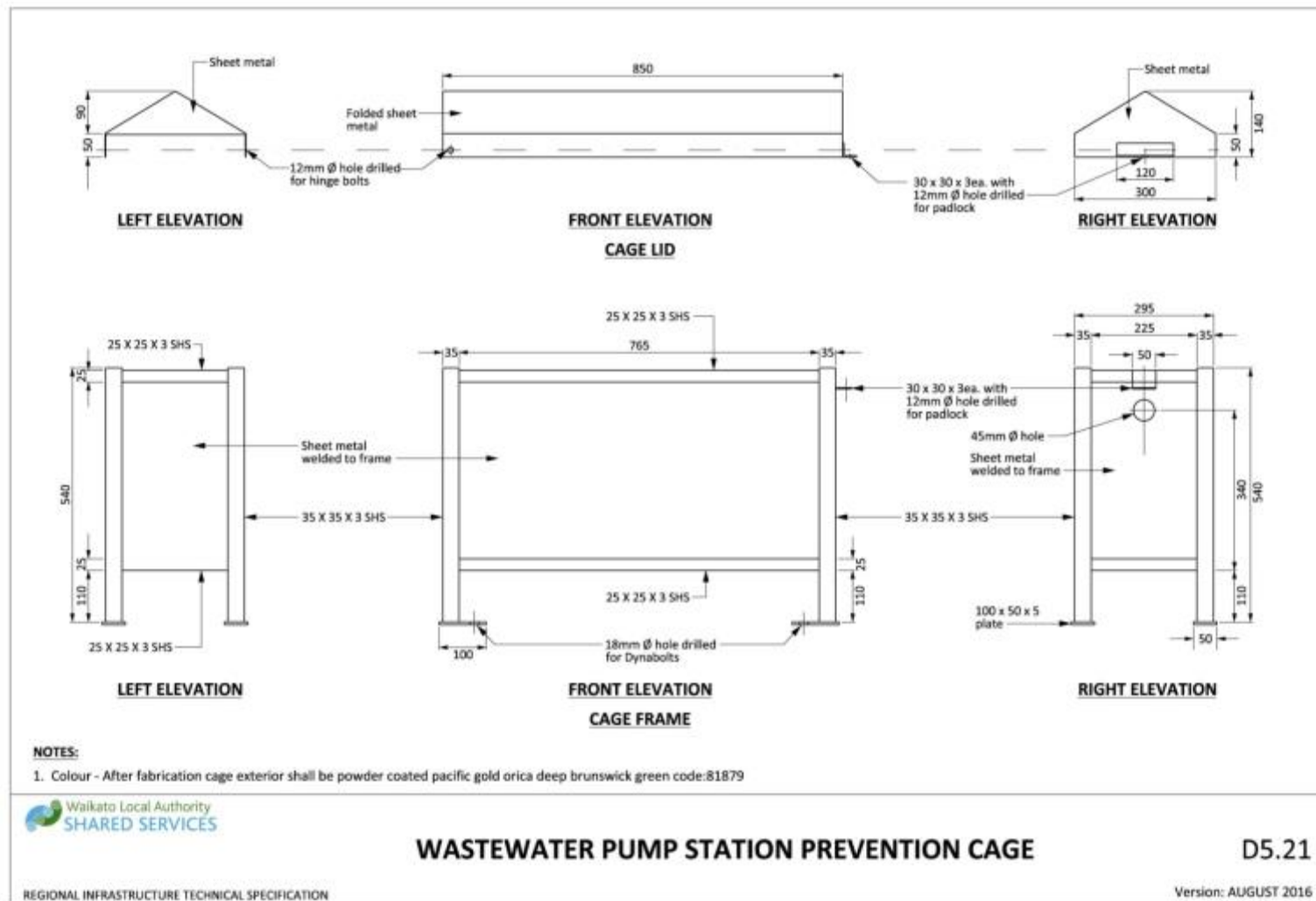

Drawing 5-21: Wastewater pump station prevention cage

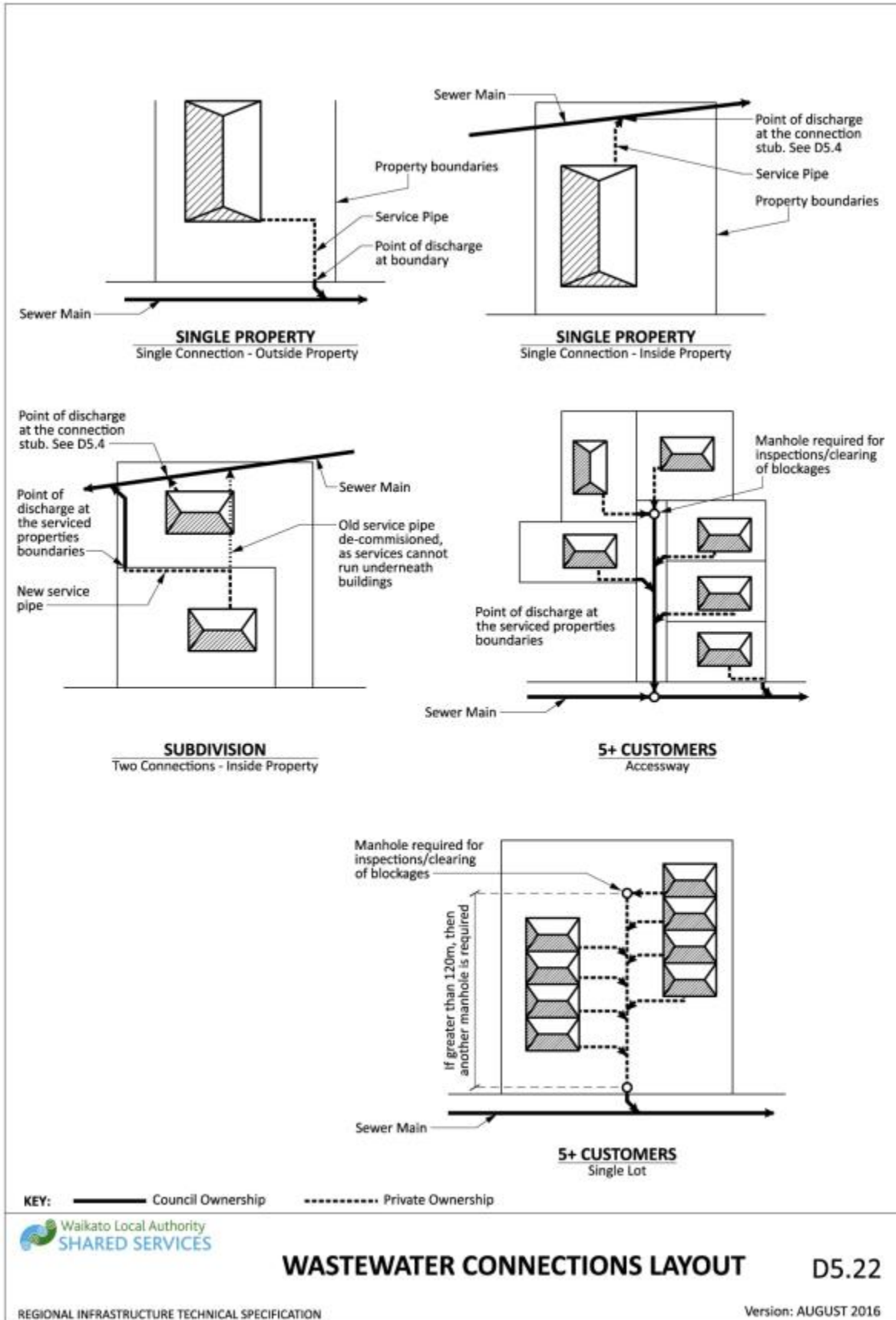

Drawing 5-22: Wastewater connections layout

6 WATER SUPPLY

6.1	Introduction	504
6.1.1	Objectives	504
6.1.2	Reference Documents.....	504
6.1.3	Level of Service.....	505
6.1.4	Alteration to Existing Infrastructure.....	506
6.1.5	Strategic Documents and Assessments	506
6.2	Design	506
6.2.1	Design Life	506
6.2.2	Acceptable Products	507
6.2.3	System Design	507
6.2.4	Clearance from underground structures	510
6.2.5	Working around structures	511
6.2.6	Shared Trenches.....	511
6.2.7	Pipeline Restraint	511
6.2.8	Hydrants.....	512
6.2.9	Valves	512
6.2.10	Connections	513
6.3	Construction	516
6.3.1	Pipe Laying	516
6.3.2	Setting Out of Water Mains in Road Reserve	516
6.3.3	Jointing.....	516
6.3.4	Pipe Fittings	517
6.3.5	Anchor or Thrust Blocks	517
6.3.6	Valves	517
6.3.7	Valve and Hydrant Boxes.....	517
6.3.8	Connections	518
6.3.9	Embedment, Backfilling and Reinstatement	519
6.3.10	Pressure Testing	520
6.3.11	Disinfection and Flushing	520
6.3.12	Watermains to be Kept Charged	523
6.3.13	Abandoned Water mains	524

LIST OF APPENDICES

No table of figures entries found.

LIST OF TABLES

Table 6-1: Standard Pipe Details	507
Table 6-2: Standard Pipe Configuration	507
Table 6-3: Rider Mains.....	508
Table 6-4: Minimum Cover Requirements.....	509
Table 6-5: Valve Description	513
Table 6-6: Valve and Hydrant Tolerances.....	518
Table 6-7: Forms and Checklists.....	525
Table 6-8: Drawing Register	530

LIST OF FIGURES

No table of contents entries found.

LIST OF DRAWINGS

Drawing 6-1: Typical urban water supply network layout..... 531

Drawing 6-2: Sluice valve details 532

Drawing 6-3: Fire hydrant details 533

Drawing 6-4: Valve indicator and post details..... 534

Drawing 6-5: Ridermain in a cul-de-sac 535

Drawing 6-6: 20mm metered and unmetered service connections - on demand and restricted flow supplies 536

Drawing 6-7: DN20 metered and unmetered service connections on demand 537

Drawing 6-8: DN50 meter connection 538

Drawing 6-9: DN100 and DN 150 meter connections..... 539

Drawing 6-10: Water connections layout..... 540

Drawing 6-11: Flush out valve assembly..... 541

Drawing 6-12: Location of services in transport corridor..... 542

LIST OF EQUATIONS

No table of figures entries found.

6.1 INTRODUCTION

This section sets out requirements for the design and construction of water networks for land development and subdivision. It covers the design of water pipes for the purpose of supplying water for drinking, including Restricted Flow Supply, and firefighting purposes up to and including 250 mm diameter. All trunk mains and reservoirs will require specific design and are excluded from this specification.

6.1.1 Objectives

To supply the required quality and quantity of water to all customers as required by legislation and to Council’s minimum level of service.

The design of the water network shall ensure an acceptable water supply for each property, including fire flows, by providing a service connection from the watermain to each property

Designers shall consider the hydraulic adequacy of the network including the specified levels of service, water quality and impact on the existing network.

The water network shall meet the minimum design life requirements of 100 years taking into account structural strength, design loadings, soil conditions and water conditions (internal and external corrosion).

The water network shall be cost efficient over its design life while accounting for environmental and community impacts through integrated three waters management and water conservation.

6.1.2 Reference Documents

Details of documents referenced in this section are as follows:

Table 6-1: Documents referenced

Reference	Standard / Document
AS 1579:2001	Arc-welded steel pipes and fittings for water and wastewater
AS 1628:1999	Water Supply : Metallic gate, globe and non-return valves
AS 1646.1:2007	Elastomeric seals for waterworks purposes
AS 3996:2006	Access covers and grates
AS/NZS 2032:2006	Installation of PVC pipe systems
AS/NZS 2033:2008	Installation of polyethylene pipe systems
AS/NZS 2280:2014	Ductile iron pipes and fittings
AS/NZS 2566.1.1998	Buried Flexible Pipelines – Structural design
AS/NZS 2638.2:2011	Gate Valves for waterworks purposes; Part 2 : Resilient seated
AS/NZS 2845.1:2010	Water supply – backflow prevention devices – materials, design and performance requirements
AS/NZS 3725:2007	Design for installation of buried concrete pipes
AS/NZS 4040:2005	Testing of products for use in contact with drinking water
AS/NZS 4058:2007	Precast concrete pipes (pressure and non-pressure)
AS/NZS 4087:2011	Metallic flanges for waterworks purposes

Reference	Standard / Document
AS/NZS 4129:2008	Fittings for polyethylene (PE) pipes for pressure applications
AS/NZS 4130:2009	Polyethylene (PE) pipes for pressure applications
AS/NZS 4158:2003	Thermal bonded polymeric coatings on valves and fittings for water industry purposes
BS 5154:1991	Specification for copper alloy globe, globe stop and check, check and gate valves
BS 5163:2004	Valves for waterworks purposes. Predominantly key operated cast iron gate valves
NZS 4404:2010	Land development and subdivision infrastructure
NZS 4442:1988	Welded steel pipes and fittings for water, sewage and medium pressure gas
NZS 4541:2003	Automatic Fire Sprinkler Systems
NZS 7643:1979	Code of practice for the installation on unplasticised PVC pipe systems
SNZ PAS 4509:2008	NZ Fire Service Fire Fighting Water Supplies Code of Practice
ISO 13953:2001	Polyethylene Pipes and Fittings – Determination of the Tensile Strength and failure mode of test pieces from a butt-fused joint
Building Act 2004	
Health Act 1956	
MBIE Building Code	Compliance Document G12 Water Supplies
NZ Utilities Advisory Group (NZUAG)	National Code of Practice for Utility Operators' Access to Transport Corridors (2010)

6.1.3 Level of Service

6.1.3.1 On Demand Water Supply Area

The design of the network shall conform to the Code of Practice for Fire Fighting Water Supplies (SNZ PAS 4509), and shall be such that a water supply connection can be provided for each lot.

The water supply network shall achieve the following standards:

- a) The residual pressure and flow at point of supply to residential lots shall be a minimum of 200 kPa (20m) and 25 L/min. Some specific areas may require a higher Level of Service – check with the relevant Council.
- b) The minimum fire supply service level shall be FW2 for residential areas and FW3 for all other areas. Some specific areas may require a higher level of service.
- c) To protect level of service of new subdivisions, no more than 150 residential Lots shall be serviced, at any point from a single ended 150mm diameter watermain (unless water modelling proves that DN100 will be sufficient, but then no more than 40 residential lots). Connectivity of the water network is to be confirmed prior to further lots being brought forward for 224(c) release.

For the purpose of pipeline design, the maximum static pressure at ground level for each lot shall be considered to be 1000 kPa. Therefore the design pressure range for specific pipeline design is 100 kPa to 1000 kPa (10-100m).

6.1.3.2 Restricted Flow Water Supply Area

The design of the network shall provide a water supply to the Water Supply Area “Restricted areas” and to the conditions as set out in Council’s Water Supply Bylaw.

The water supply network shall achieve the following standards:

- a) The flow to the lots within the Water Supply Area Restricted areas shall be no less than 1.8 m³/per day, however some specific areas may require a higher level of service.
- b) The flow is to be a steady rate through the meter.
- c) Properties reliant on the Water Supply Area Restricted areas must consider the separate provision of fire-fighting capacity as this is not provided by this restriction. Some councils require that the Fire Service SNZ COP PAS 4509 be met through their District Plan provisions.

6.1.4 Alteration to Existing Infrastructure

Connection of a new development may require upgrading or extending the existing water network must maintain the minimum level of service for the existing infrastructure.

Alteration of the existing water network to achieve the required level of service and standards for development outside of the On-Demand Water Supply Area the Water Supply Area, or Restricted Supply Area shall be at no cost to Council.

6.1.5 Strategic Documents and Assessments

All design shall be undertaken in accordance with the District Plan, Bylaws, Policies and this Infrastructure Technical Specification.

Where the following documents exist, planning and design of a water network extension shall be in accordance with the principles and requirements contained within an approved Integrated Catchment Management Plan, Water Impact Assessment, Asset Management Plan and Water Demand Plan.

Council will advise developers of the existence of the relevant documents during initial discussions regarding development. Design shall not occur until the requirements have been confirmed.

The documents may contain details of strategic infrastructure to be located within the development area. The responsibility for the design and construction of strategic infrastructure shall be agreed with Council prior to commencing design.

6.2 DESIGN

6.2.1 Design Life

Water Supply Infrastructure shall be designed and constructed for an asset life of at least 100 years, with timely maintenance as defined in the Asset Management Plan. Some components such as pumps, electrical and electronic components and control equipment may require earlier renovation or replacement.

6.2.2 Acceptable Products

Refer to [Accpetable Products Section 8](#).

Materials and pressure rating for pipelines greater than DN250 shall be determined by specific design and in consultation with Council.

6.2.3 System Design

Water mains shall be designed with sufficient capacity to cater for all existing and predicted development within the area to be serviced.

Water mains shall not be located on private property unless approval from Council has been granted.

The water demand calculations in the subdivision design shall provide for:

- a) A domestic demand of 260 litre/person/day with a peak flow rate of five times this amount for On Demand Supply.
- b) For Restricted Flow Supply, use 1.2m³/lot/day
- c) Population targets
- d) The area to be serviced
- e) Property size and layout
- f) Proposed land use (zoning)
- g) Design pressures including the requirements of SNZ PAS 4509.

For general application, Council has standard sizes for all water mains as shown in the table below. Pipe sizes other than those listed below shall not be used on the Council water supply network. All trunk mains will require specific design.

Table 6-2: Standard Pipe Details

SIZE AND MATERIAL	
Connections	Various Sizes, PE 80B MDPE
Rider Mains	63 mm OD MDPE (DN 50), PN12.5
Firemains/Principal Mains	DN 150 PVC or PE 100 (unless water modelling proves that 100mm will be sufficient), DN 200, all PN12.5
Trunk Mains	DN 250, DN 300 Series 2 PVC-O or DN 315, DN 355 PE 100 (see note 2.)

Notes

1. DN 200 may be used to provide firefighting flows and in that situation can have service connections.
2. >DN 300 is considered a bulkmain and requires specific design in consultation with council

Table 6-3: Standard Pipe Configuration

AREA	CONFIGURATION
Residential	Principal main on one side of the road and a rider

	main on the other
Industrial, Commercial, medium and high density residential and Arterial or Dual Carriageway Streets	Principal main on both sides of the road
All Other Areas	Principal main on one side of the road and a rider main on the other

Table 6-4: Rider Mains

PRESSURE	MAXIMUM NUMBER OF DWELLING UNITS	
	ONE ENDED SUPPLY	TWO ENDED SUPPLY
Medium Pressure ((400-600 kPa)	15	30
Low Pressure (<400 kPa)	7	15

Potable Water - Free Available Chlorine (FAC) at end of supply shall be 1.5g m³

Where the number of dwelling units exceeds the maximum number for a rider main an additional connection/road crossing shall be installed or a principal main shall be installed on both sides of the road.

6.2.3.1 General Design Notes

- a) By convention, PVC pressure pipes in New Zealand are usually referred to by their nominal internal diameter (i.e. DN 50, 100, 150 etc.) whereas the equivalent size ISO dimension PE pipes are usually referred to and specified by their nominal outside diameter (i.e. 63, 125, 180 OD).
- b) In any instance where an external diameter is shown on a drawing or specified it shall be deemed to be PE. Dimensions in absence of either “ID” or “OD” shall be assumed by Council to refer to an internal diameter and be PVC.
- c) To support future growth Council may require mains to be upsized – see the relevant Council plan(s), as referred to in 6.1.4 above, for details.
- d) All undersized mains associated with a development shall be upsized to the minimum requirements with no cost to Council and detailed in a Development Agreement or resource consent conditions.
- e) The design of the reticulation shall be such that a water supply connection can be readily provided to the ‘front’ of each allotment but avoiding the potential driveway location. No connection shall pass under a roadway.
- f) Dead end water main design should be avoided by the provision of linked or looped mains. Staged developments shall terminate with a temporary fire hydrant for mains or flushing valve for rider mains.
- g) Drinking water supply systems shall be designed and equipped to prevent backflow. The location and operation of hydrants, air valves and scours shall ensure no external water enters the system through negative pressures from normal operation.
- h) The standard position of water mains in the transportation corridor shall be in the roadway berm, parallel to and 2.0m from the (average) property boundary (1.5m behind face of kerb) in accordance with National Code of Practice for Utilities’ Access to Transport Corridors (NAUAG) and Transportation [Drawing D3.1.3](#). Where water mains cannot be laid in the standard alignment, an alternative

alignment showing the relative locations of all services shall be designed and proposed with the engineering plans.

- i) Water main crossings in roads, railway lines, and underground services shall, as far as practicable, be at right angles. Mains should be located to facilitate maintenance. At road intersections, 90 degree tees or 90 degree bends are required. Refer [Drawing D6.1](#))
- j) Root boxes will need to be provided for new developments to protect mains from tree root damage. Refer to the Landscaping Section. For retrofit situations refer to Council for advice.
- k) Minimum cover requirements are shown in [Table 6-4](#). The sections of main adjacent to a carriageway crossing shall be gradually deepened, to allow the required cover under the carriageway without the provision of vertical bends. Similar provision shall be made to ensure the necessary cover over valve and hydrant spindles.

Table 6-5: Minimum Cover Requirements

SITUATION	MINIMUM COVER (M)
Principal mains and rider mains in berm	750
Principal mains and rider mains under carriageways	900
Service connection pipes	350
Trunk mains	900

6.2.3.2 Rural Area Design Notes

- a) Restricted flow water supply schemes do not provide firefighting capacity.
- b) Individual rainwater tanks, individual privately owned bores, wells or restricted supply, may adequately serve isolated small subdivisions in rural settings.
- c) Where rain water tanks are provided for the purpose of rain water harvesting and reuse within the building, the design for domestic demand can be reduced to 225 litres/person/day except in rural trickle supply areas.

6.2.3.3 Fire Fighting Supply

Council’s standard design meets the FW2 firefighting requirements at the street boundary for residential areas and provides for FW3 for other zones. Some specific areas may require a higher level of service. Where additional firefighting coverage is required, private storage shall be designed to comply with the requirements SNZ PAS 4509.

The minimum requirements are based on SNZ PAS 4509, however this may need to be increased to ensure security of supply for operational purposes within the premise.

It should not be assumed that current pressure and flow will be available in the future when designing private fire services as these are likely to reduce in the future due to demand growth and pressure management.

6.2.3.4 **Structural Design**

The pipeline installation shall be specifically designed to resist structural failure (static and dynamic loads). The design shall be in accordance with AS/NZS 2566.1 including Supplement 1 and the manufacturer's specification. Details of the final design requirements shall be shown on the drawings.

Where the watermain is being laid in an area of fill, advice should be sought from a geotechnical engineer and provided to Council.

6.2.3.5 **Above-ground Water Mains**

Above-ground water mains should be avoided. If necessary, specific engineering design will be required and approved by Council.

The specific engineering design of above-ground water mains shall include and is not limited to the following:

- a) the design of pipeline supports for static and dynamic forces
- b) maintenance and access requirements
- c) pipe thermal movements
- d) provide corrosion protection, UV protection and insulation to prevent the freezing of water mains.

6.2.3.6 **Non-Council Supply**

In order to meet the requirements of the Building Act and Health Act in all developments outside of a water supply area, details of the source, capacity and quality of the existing and proposed water supply shall be provided to Council in accordance with the LGA and the NES for Sources of Human Drinking Water.

The Developer should check with the District Health Board to see if the supply needs to be registered or not.

Where any property is connected to Council's water supply network and uses an alternative supply of water for any purpose, reference shall be made to the requirements set out in the relevant Council's Water Supply Bylaw must be met.

Cross connections between any other water supply is prohibited.

6.2.3.7 **Water pipes laid in HAIL sites**

For water pipes that will be laid in areas identified as being HAIL sites, a specific design shall be undertaken.

6.2.4 **Clearance from underground structures**

Clearance from underground services shall be as per NZS 4404 Section 6.3.9.1 and [Drawing D3.1.3](#).

Water mains laid parallel to power mains shall maintain a minimum horizontal clearance of 400mm at all times, including between meter boxes and power plinths.

6.2.5 Working around structures

Watermains that are located close to structures, such as foundations for walls and buildings, must be clear of the “zone of influence” of the structure’s foundations. Refer to the table below for guidance on minimum clearances from structures.

Table 6-6: Minimum Clearance from structures

PIPE DIAMETER DN (MM)	CLEARANCE TO WALL OR BUILDING(MM)
0-150	1500
≥200	2500

These clearances may need to be increased for mains in private property (even with easements) as access could be more difficult and damage risk greater.

6.2.6 Shared Trenches

Where shared trenching is approved by Council and all affected utility owners, a detailed design shall be submitted for approval by those parties and shall include:

- a) Relative location of services (horizontal and vertical) in the trench
- b) Clearances between services
- c) Pipe support and trench fill material specifications
- d) Trench marking – blue metallic tracker tape
- e) Services’ location from property boundaries
- f) Any limitations on future maintenance
- g) Special anchoring requirements, such as for bends and tees

See [Drawing D6.13](#).

6.2.7 Pipeline Restraint

Anchorage shall be provided at bends, tees, reducers, valves and dead ends where unbalanced thrust occurs.

6.2.7.1 Anchor Blocks

The design of anchor blocks shall be based on the maximum test pressure and the allowable bearing capacity of the site soil conditions, except that the maximum value used shall be 75 kPa. The inner face of the block shall not be of a lesser thickness than the diameter of the fittings, and shall be constructed so as not to impair access to the bolts on the fittings. Concrete shall have a minimum compressive strength of 17.5 MPa at 28 days.

Anchor blocks are to consist of sufficient mass concrete to prevent pipe movement, refer NZS 4404 Appendix B drawing WS – 004 and 005.

6.2.7.2 Restrained Joint Water Mains

Commercially available, mechanically restrained, jointing systems may be used to avoid the need for thrust and anchor blocks subject to the specific written approval of Council.

6.2.8 Hydrants

Hydrants are installed in reticulation systems for firefighting and/or operational purposes. Operational purposes may include mains flushing, chlorination, and to allow the escape of air during charging and the release of water during the dewatering of the main.

6.2.8.1 Hydrant Design

- a) Hydrants are to be located in the road berm and not in the carriageway. However, NZS 4509 requires hydrants not to be located within 6.0m of any existing or proposed building. Where this is not possible, advice should be sought from Council
- b) Hydrants shall not be fitted to any main less than DN 100.
- c) Hydrant risers shall be used, or the water main laid deeper, where necessary to ensure the top of the spindle is between 50mm and 200mm below the fire hydrant lid.
- d) Hydrants shall be spaced at intervals not exceeding the following:
 - i. Residential areas 135m
 - ii. Commercial and Industrial areas 90m (on each side of the road)
- e) In a cul-de-sac or in temporary road ends the last hydrant shall be not more than 65m from the end of the road measured along the road boundary.
- f) Where houses or residential units are situated on private ways, there shall be a hydrant within 135m of any house or unit measured along the vehicle path (this is where fire hoses would be laid out).
- g) Hydrants should be located clear of vehicle crossings (in the grassed roadway berm). In new developments, where formation of vehicle crossings are deferred until construction of the buildings, hydrants should be located in the centre of the street frontage to avoid the most likely location of the vehicle crossings alongside boundaries.
- h) In addition to hydrant spacing for firefighting, hydrants shall be positioned at high points to facilitate flushing air from the mains and at low points to facilitate flushing sediment from the mains.
- i) Hydrants shall be placed within hydrant boxes designed in accordance with the [Drawing D6.3](#). The location of the hydrants shall be marked in accordance with the requirements set out in SNZ PAS 4509.
- j) Flushing points (hydrant or valve) shall be installed at the end of DN 100 and larger ([Drawing D6.1](#)) / 63 OD rider mains ([Drawing D6.11](#)).

6.2.9 Valves

Valves shall be installed to permit isolation of sections of the pipe network for maintenance and operational purposes. The spacing and location of valves shall be such as to limit the number of dwellings affected by a shutdown to no more than 40.

Valves shall be provided as follows.

- a) Each side of arterial roads and railway crossings
- b) Adjacent to street intersections, having regard to the safety requirements for operational access
- c) On at least two legs leading from each tee intersection

- d) A maximum spacing of 250m

Subject to these considerations, valve numbers shall be minimised.

Attention should also be given to the location of the valve in particular:

- Ensure that the valve can be operated safely, i.e. traffic management requirements
- Avoid clustering of surface fittings in the footpath at intersections.
- The design shall ensure valve positioning places them outside of the sealed carriageway, behind the kerb and in the grass berm.

Valves shall be installed next to other fittings such as tees or bends where possible. Refer drawing [D6.2](#) for details.

6.2.9.1 Valve Types

Table 6-7: Valve Description

VALVE TYPE	
Sluice Valves	Sluice valves shall be used on principal mains. The valves shall be resilient seated, anticlockwise closing with a non-rising spindle to NZS/AS 2638.2 (pressure rated PN16). All valves shall be thermal-bonded polymeric coated to AS/NZS 4158
Gate Valves (also known as Peet Valves)	Gate valves DN 50 or less shall be clockwise closing with cast iron T bar handles. Valves to be manufactured to BS 5154 or AS 1628
Air/Vacuum Valves and Scour Valves	Shall only be used when required by Council. Air valves and Scour valves shall be specifically designed to suit the installed location
Butterfly Valves	The use of butterfly valves shall only be used with the specific approval of Council

6.2.10 Connections

6.2.10.1 General

Before connection to the water network, the Council connection process and forms shall be completed by the applicant and acceptance provided. This applies to the following situations:

- All new connections and disconnections for private property.
- Connections of new water mains to the existing public watermains.
- All temporary connections.

For all connections where volumes greater than 15m³/day are required, compliance with the Council’s Water Take Resource Consent, or bylaw, is required where specified.

The connection should be designed to suit the existing situation and any future development and be supported with an approved Plan as described in 6.1.4.

Council advises all commercial and industrial premises, and others reliant on continuous water supply, to have operational storage to suit their needs (e.g. 24 hours).

Refer to Drawing [D6.10](#) for connection layouts.

6.2.10.2 Requirement of Design

The point of supply to the consumer is shown on Drawings [D6.6](#) and [D6.7](#).

The following design requirements shall be met.

- a) All residential connections shall be DN20 unless the pressure from the reticulation is less than 10m or served by an access way longer than 45m. In these cases a DN25 connection is required
- b) Other customers' connection sizing will be determined by specific design and agreed with Council. However, no connection shall be sized at the same size as the Council main it is drawing flow from.
- c) No connections will be allowed from bulk mains.
- d) Connections from trunk mains greater than 250mm will require specific approval from Council.
- e) For front properties, service connections shall be located at the centre of the road frontage or adjacent to vehicle entrances. For a rear lot serviced by an access strip, the service connection shall be located adjacent to the access vehicle entrance.
- f) The service connection shall have a meter (if required by Council), a manifold incorporating a toby valve and backflow preventer under a meter box located in the road reserve, 300mm from the boundary and the supply connection shall be extended a minimum of 300mm inside the boundary (refer to Drawings [D6.7](#), [D6.8](#), [D6.9](#), [D6.10](#)).

6.2.10.3 Services in Access Ways, Access Lots, or Right of Ways

The following shall apply.

- a) Where there are between two and four lots on a right of way an appropriately sized manifold box and lid is to be used to house up to 2 service connections per box. The manifold box shall be located in the right of way clear of vehicle traffic movements and adjacent to the vehicle entrance.
- b) Where five or more service connections will be required in an access lot or right of way, a single pipe shall be used, subject to the following design criteria.
 - i. A rider main of DN50 MDPE shall be used, unless firefighting requirements control the design
 - ii. Service pipes crossing the access lot shall be DN25 MDPE and shall be placed in a DN50 duct.
 - iii. The service pipe connections to the rider main shall be in the grass berm
 - iv. Service connections, meters (where applicable), manifold boxes and gate valves shall be constructed to Drawing [D6.6](#) and [D6.7](#).
 - v. The rider main shall have a 50mm flushing valve of the furthest point from the reticulation. Refer Drawing [D6.11](#).
 - vi. Metallic detector tape, laid directly above the rider main at a maximum depth of 200mm is required where; the alignment of the pipe is not clearly defined as a straight line between valve box lids and, in other circumstances as required by Council

- vii. An "Easement in Gross" over the right of way shall be granted in favour of the Council for water supply purposes to allow access for maintenance of ridermain and connections.
- viii. Ownership of the ridermain shall transfer to Council. The Council's responsibility for maintenance of the service pipes shall cease at the boundary to each individual lot

6.2.10.4 **Multi-Unit Properties**

Council does not own or operate pipelines on private property (except as per Section 6.2.10.3). Unit Title developments are recommended to conform to service connection layouts described in Section 6.2.10.3 above in order to facilitate for subsequent subdivision should this be required as a future development of the site.

Isolation valves for individual units (required under Clause 5.4.1 of the Building Act Compliance Document G12 Water Supplies) shall be located outside of the building platform but within the property.

6.2.10.5 **Connections in Rural Restricted Supply Areas**

Connections in rural restricted supply area are to be constructed as per those in 6.2.10.3 above.

All connections in rural restricted supply areas are to be metered.

6.2.10.6 **Water Meters**

Residential Connections

Manifold boxes, manifolds and meters (where required by Council) are to be installed on all connections as per Drawing [D6.6](#) and [Acceptable Products Section 8](#).

Heavy-duty manifold boxes for use in trafficked areas shall be used.

Where four manifold boxes are to be installed side by side, the use of two Jumbo manifold boxes can be used as per Drawing [D6.7](#).

Restricted, Commercial and Industrial Connections

Water meters are required to be installed in all flow restricted supply, commercial and industrial connections as per Drawing [D6.6](#).

Refer to Drawings [D6.8](#) and [D6.9](#) where water meters DN50 or larger are required.

6.2.10.7 **Fire Connections**

Many commercial and industrial developments require installation of special fire protection services. While it is the responsibility of the site owner to provide these fire services at the time of Building Consent application, the developer shall design the water reticulation system to meet the required demands, where these are known in advance.

Where a site owner requires a specific flow and pressure for internal fire systems, it will be the responsibility of the owner to provide any storage, back up facilities or equipment necessary for that level of service from within their own system.

The requirements for internal firefighting, with reference to automatic fire sprinkler systems, shall be designed in accordance with NZS 4541.

Reference should be made to the relevant Building Code and Water Supply Bylaw.

Design should take into account that Council only permits one fire connection to a single Lot and that the connection size shall be no greater than the main.

The system will require a backflow preventer to be installed on the connection

6.3 CONSTRUCTION

6.3.1 Pipe Laying

All watermain pipe laying and associated fitting installation shall only be carried out, or supervised on site, by a water service person holding the qualification of 'National Certificate in Water Reticulation' or its replacement the 'New Zealand Certificate in Pipe Installations'.

Pipes shall be handled, stored and laid in accordance with the approved pipe manufacturers specifications and relevant standards.

Pipes and fittings shall be free of defects (internally and externally) and cleaned of dirt on the inside prior to lowering them into the excavation. Pipes shall be set true to line and level and care taken to ensure that joints are kept free from dirt.

Pipe bedding and backfill shall be to the manufacturer's specification.

Pipes shall be laid with product labelling uppermost in the trench.

At any time when the pipeline is not being worked upon, open pipe ends shall be blanked off in a manner which prevents the ingress of animals and deleterious material.

6.3.2 Setting Out of Water Mains in Road Reserve

All water mains shall be laid in a straight line or following street layout. The deviation from approved design alignment permitted either in plan or elevation shall be:

- Open Cut – ± 50 mm on straight and 100mm in curves
- Drilling – ± 150 mm

6.3.3 Jointing

Electrofusion and butt welded jointing shall only be carried out by experienced certified PE welders.

The certifying organisation must be acceptable to Council. In addition, welders may be required to carry out satisfactory test welds for each joint type and to stamp the welder's number on each joint.

Butt welds shall be, at least, 90% of the tensile strength of the parent pipe material, when tested in accordance with ISO 13953.

6.3.4 Pipe Fittings

Pipe fittings such as tees, hydrant tees, crosses, tapers, hydrant risers, blank caps, plugs, bends of various degrees, and surface boxes (where applicable) shall be of cast iron, or other metallic material and manufacture as listed in [Section 8: Acceptable Products](#).

Cast iron fittings shall be cast from high quality grey iron coated with a proven corrosion preventative compound after adequate preparation.

Flanges shall be to Table E of NZS 8. Fittings laid contiguous with other fittings shall have flanged joints, or flexible joints where permitted (gibault or supertite).

All bolts and nuts shall be hot dip galvanised.

Gaskets for flanged joints shall be to BS 5292.

6.3.5 Anchor or Thrust Blocks

Cast in situ concrete anchor blocks shall be provided at all points where an unbalanced thrust occurs on mains exceeding 50mm diameter.

The design of anchor blocks shall be based on the test pressure and bearing value of the site soil conditions, except that the maximum value used shall be 75 kPa. The inner face of the block shall not be of a lesser thickness than the diameter of the fittings, and shall be so constructed as not to impair access to the bolts on the fittings. Concrete shall have a minimum compressive strength of 17.5 MPa at 28 days.

A protective Denso or black protective coating membrane to protect abrasive damage to the water main should be provided between the pipe (irrespective of the pipe material) and the concrete anchor and thrust blocks.

6.3.6 Valves

Where the valve is fitted to the branch of a tee it shall be flanged unless this results in the valve being in the carriageway. In these cases spigot ended valves connected to adjoining pipes with gibaults are the acceptable alternative. Spigot ended valves shall be secured to anchor blocks designed to NZS 4404.

6.3.7 Valve and Hydrant Boxes

6.3.7.1 Berm Areas (Includes Installations in the Road Berm)

Valve and hydrant boxes located in berm areas shall be in accordance with Drawings [D6.2](#) and [D6.3](#). At least one, but no more than three, cast iron packers shall be used in any one installation.

Backfill and reinstatement shall be in accordance with the Transportation Section.

6.3.7.2 Carriageway Areas

Valve and hydrant boxes located all streets shall be in accordance Drawings [D6.2](#) and [D6.3](#) and with the following:

- a) No more than three cast iron packers shall be used in any one installation
- b) The base shall be well compacted and properly levelled prior to installation of the concrete surrounds

- c) The edge of the excavation shall be saw cut to provide a neat and clean edge for reinstatement
- d) The valve or hydrant box is to be installed parallel to the main
- e) The box and surrounds shall be installed so that no traffic load on the surface box can be reflected onto the pipe or fittings

Specific requirements regarding valve boxes include:

- The direction of the pipe shall be indicated by the longer side of the lid
- Valve surface boxes in grassed or planted areas shall be firmly and securely surrounded with a cast insitu or approved precast flush concrete edging
- A single section of 200mm diameter PN12 uPVC pipe shall be used as a riser with a circular surface box. Precast risers to be used for rectangular boxes.

6.3.7.3 Tolerances

The top surface of the cast iron valve or fire hydrant box shall be neither raised nor depressed from the surrounding ground or seal, and the following tolerances shall be adhered to.

Table 6-8: Valve and Hydrant Tolerances

	GRASS BERM	PAVEMENT	FOOTPATH
Local, Collector and Arterial Roads	+ 5mm, – 5mm	+ 0mm, -5mm	+10mm, -0mm

The tolerances shall be measured from a 1.0m diameter of the surrounding surface across the box and work may be rejected if the tolerances are not met.

6.3.7.4 Valve and Hydrant Markers

Marker posts shall be installed near all valves in accordance with Drawings [D6.1](#) and [D6.4](#).

All fire hydrants and valves shall be marked according to SNZ PAS 4509:2008 which includes the following requirements.

- The lid of the fire hydrant box painted yellow with NZTA M/7-Y
- A yellow painted triangle on or near the centre line of the road
- A yellow painted circle encircling the hydrant if its location can be obscured by parked vehicles

Fire hydrants shall be indicated with blue raised reflective pavement markers in addition to the markings indicated above. (Refer to SNZ PAS 4509).

6.3.8 Connections

Refer to drawings [D6.6](#), [D6.7](#), [D6.8](#) and [D6.9](#).

All connections shall be sealed by removable caps until such time as they are required. For the purpose of health protection, the use of electrical tape is not allowed as a cap.

All connections and disconnections to or from Council live pipes and all works outside the property boundary shall be undertaken by Council, or Council approved contractors.

The physical connection to the existing water reticulation can only be carried out once the pressure and bacteriological test results have been submitted to, and approved by Council.

Connections shall be made under pressure wherever possible.

Care shall be taken during installation of the connection to ensure that no foreign matter enters the pipes or meter. All meters shall be checked after installation to ensure that the meter is recording the flow passing through it.

The location, lot number, water meter and backflow preventer serial numbers, shall be recorded. Confirmation of the installation of a flow restrictor is required when fitted.

6.3.8.1 Tapping Bands, Ferrules and Service Pipes

Service connections to principal mains shall be by means of a tapping band and a ferrule. Service connections to rider mains shall be by means of a tee-joint or Tapping Saddle. Ferrules are to be left fully opened and gate valves fully closed.

All service pipes shall be laid at right angles to the street in accordance with Drawings [D6.6](#), [D6.7](#) and [D6.8](#)).

Tapping bands and ferrules on the water main shall be fitted when the mains are first laid.

6.3.9 Embedment, Backfilling and Reinstatement

Pipes and fittings shall be surrounded with a suitable bedding material and backfilled using an approved hard fill placed immediately above the pipe embedment and compacted in layers not exceeding 200mm in loose depth in accordance with the pipe manufacturer's specifications, [Drawing D3.2.3](#) (Transportation) and AS/NZS 2566.

The depth of basecourse and type of the finishing seal coat shall conform to the standard of the existing road construction.

Compaction test results (or substituted scala penetrometer tests) shall be submitted to Council as part of the approval process.

6.3.9.1 Detector Tape

For open trenching, detector tape shall be placed approximately 200mm below final ground level and metallic 'detector' tape coloured blue, stipulating 'Danger – Water Main Below' (or similar) shall be laid.

6.3.9.2 Tracer Wire

Directional Drilling or Micro Tunnelling - Tracer wire, in the form of a continuous 4mm² multi strand (minimum four) polythene sleeved copper cable, shall be installed with all non-metallic pipes to allow detection. The wire shall be strapped to the pipe wall by means of a minimum of two complete wraps of heavy duty adhesive tape, at a maximum of 3.0m intervals. The wire shall have some slack to allow for bends in laying and for future installation of tapping saddles.

The tracer wire shall run continuously between valves and hydrants. At each valve or hydrant the wire shall be ducted to surface level through a length of polyethylene pipe ending immediately below the lid. The tracer wire shall be long enough to extend 600mm minimum above ground level when uncoiled. The excess length shall be neatly coiled in the valve or hydrant box.

The tracer wire shall be tested for continuity between surface boxes using an electronically generated tone and detector probe or alternative approved method.

6.3.10 Pressure Testing

6.3.10.1 General

At least one working days advance notice shall be given to council for pressure testing of pipelines.

All pipelines shall be pressure tested and backfilled after anchor blocks, specials and fittings are completed, but with joints and connections visible. The final tests are to be witnessed by Council prior to the pipe being connected to the 'live' network. No further connections will be permitted after this stage.

6.3.10.2 Steel, Ductile Iron and PVC Pipes

Refer to NZS 4404 Appendix C3 for the requirements or if this not available, the pipe manufacturer's procedure.

6.3.10.3 MDPE Pipes

Refer to NZS 4404 Appendix C3 for the requirements or if this not available, the pipe manufacturer's procedure.

6.3.11 Disinfection and Flushing

Appendix D of NZS 4404 – Water Supply Disinfection Specification shall apply and is quoted below:

D1 Disinfection of pipelines and fittings

After flushing the main to remove all debris and air, the main shall be filled with water containing a free available chlorine concentration of 15 g/m³ ± 5 g/m³ and allowed to stand for a minimum of 12 hours for all new mains. At the end of the disinfection period, the free available chlorine (FAC) concentration shall be at least 5 g/m³. If the FAC is less than 5 g/m³ at the completion of the period, the disinfection shall be repeated until a satisfactory result is obtained. Note that the main should not be rained after flushing unless all high points are 'vented' to allow for complete removal of air.

Under no circumstances will the use of handfuls of hypochlorite powder or chlorine tablets dumped into the pipe and hydrant tees be an acceptable practice.

The sterilising solution should be fed by gravity or pumped into one end of the main and the 'flushing' water in the pipe displaced out of the opposite end of the main until tests carried out show that the water being displaced contains the full FAC concentration and, to this end, the contractor shall give 24 hours' notice of intention to sterilise.

The contractor shall provide all temporary fittings necessary to allow for the introduction of the sterilising solution to and its removal from the main.

See also D3.

D2 Methods of introducing the sterilising solution

Methods of introducing sterilising solution will depend on the volume of solution required for the particular main and the availability of appropriate equipment.

In general, wherever the pipe volume is less than 10 m³, the most practical method is to add sufficient calcium or sodium hypochlorite (powder or solution) to a potable water tanker suitable for carrying potable water to achieve the desired 15 g/m³ FAC concentration. (This may require two tankers full.)

For greater quantities, the sterilising solution may be injected into the main using a portable gas chlorinator or a hypochlorinator. An approved backflow preventer shall be installed if either of these options is used.

D3 Disposal of sterilising solution

After the satisfactory completion of the sterilising process, the chlorine solution shall be flushed into the sanitary wastewater pipe or, alternatively, retained in a temporary surface storage pond until the TA's authorised officer is satisfied that the FAC has reduced to a part concentration before being allowed to flow down the stormwater drainage system or into a natural watercourse.

If the sterilising solution cannot be discharged to a sewer, it shall be neutralised with Sodium Thiosulphate or similar before discharge to the environment. Note that a discharge resource consent may be required from the Regional Council.

D4 Acceptable method for sterilising mains

Use sodium hypochlorite solution. This solution usually has 10% or 15% FAC;

Obtain a clean water tanker, as used for potable drinking water. The tanker should have a known water capacity;

Measure the required amount of sodium hypochlorite solution into a beaker and pour it into the empty tanker;

NOTE – The final strength of the chlorine to water is to be 15 g/m³ ± 5 g/m³.

Fill the tanker to the appropriate volume and ensure the solution is well mixed;

Change the new main with the chlorinated water from the tanker at one end of the main or into a new hydrant through a standpipe. All service pipes and hydrants shall be left open and allowed to run for a couple of minutes. The services and hydrants shall then be closed to allow the highest end of the main to fill completely;

NOTE – The main should ideally be charged from the highest point. This will allow the water to be gravity fed into the main. If this is not possible the water tanker shall have a truck mounted pump to pump the chlorinated water in.

Seal off the main and leave it charged with the chlorinated water for 24 hours;

Take samples and test for residual chlorine;

After 24 hours flush the main well until the chlorine smell is gone. Once the main is connected into the reticulation system it should be flushed thoroughly before the services are connected up.

NOTE – For large mains, a water tanker may not have the required capacity so a close pump system shall be used and approved by the authorised officer.

Example:

A. Calculate the volume of the mains to be chlorinated, that is, 85m of 100mm dia. Meter main

$$\text{Vol.} = \frac{85 \times \pi \times 0.1^2}{4} = 0.67 \text{ m}^3$$

$$= 667.6 \text{ litres}$$

Plus 110m of 150mm dia. Main

$$\text{Vol.} = \frac{110 \times \pi \times 0.15^2}{4} = 1.944 \text{ m}^3$$

$$= 1,944 \text{ litres}$$

$$\text{Total volume} = 1,944 + 667.6 = 2,611.6 \text{ litres}$$

B. The total volume of 2,611.6 litres is less than the volume of the water tanker (say 5,000 litres) so calculate how many millilitres of sodium hypochlorite is required for the 5,000 litre tanker to give a final solution of 15 g/m³.

$$v = \frac{V \times c}{s \times 10}$$

v = volume of sodium hypochlorite in ml

V = volume of water tanker

c = concentration of final solution in g/m³

s = strength of concentrated hypochlorite in % FAC

$$v = \frac{5000 \times 15}{15 \times 10} = 500 \text{ ml}$$

6.3.11.1 Removing the Disinfectant

Sometime after the minimum contact period for disinfection, the sterilising solution is to be flushed from the pipeline. Flushing should continue for at least 10 minutes beyond

the initial removal of the sterilising solution. Projects involving pipelines of 250 NB and larger should be flushed until such time as the residual chlorine level matches that of the normal water supply in the area (i.e. upstream of the new pipe).

Individual customer connections shall be flushed by opening each toby valve installed on the pipeline. In the case of a pipeline repair where it is not practical to flush water at the toby, an outside hose tap should be used as the flushing point for each service connection.

6.3.11.2 **Bacteriological Test**

In commissioning new pipelines, Council shall be given 24 hours' notice as to when sampling for bacteriological tests is to be carried out.

Water in the pipeline shall be sampled between 12 hours and 48 hours after post-chlorination flushing and the samples tested for the presence of E.coli, Coliforms and Heterotrophic Plate Count by a Ministry of Health Approved laboratory with IANZ accreditation for this type of test. The number of samples shall be at least one for projects involving less than 100m of pipe, two for projects up to 200m length, etc.

“A satisfactory result is <1 MPN/100ml for E.coli and Total Coliforms and less than 20 CFU/ml for Heterotrophic Plate Counts.”

If E.coli is detected the pipeline shall be swabbed, flushed, disinfected, flushed again and then the bacteriological tests repeated. The process shall be repeated until such time a clear test is recorded.

Note: There are high risks of test failure due to sample contamination so it is recommended that the testing laboratory is also involved in collecting the sample.

6.3.12 **As-built Information**

Upon completion of construction work, copies of As-built plans and data attributes of the completed works, as described in Clause 1.9 of [Section 1:General](#), shall be provided to the Council. Separate plans are required for wastewater, stormwater, and water supply.

Responsibility for providing the plans and associated data shall lie with:

- a) The Developer, in the case of land development (urban and industrial subdivision).
- b) The Contractor, in the case of works constructed for Council under contract to Council.

6.3.13 **Watermains to be Kept Charged**

After any watermain has been laid, tested and disinfected, it shall be kept continually charged with water, and under pressure. If the permanent connection to the existing reticulation is delayed by more than 5 days, a temporary small diameter connection shall be made from the existing reticulation. The pressure must be maintained while other underground services are being laid in the vicinity of the new main.

6.3.14 Abandoned Water mains

In the event that a water main is decommissioned, all removable valves, hydrants, fittings and surface boxes shall be recovered. The items shall be recycled, either by delivery to Council for reuse or by delivery to a scrap metal merchant.

Council shall be provided with an opportunity to inspect the removed items and direct which recycling option is to be taken.

FORMS AND CHECKLISTS

Table 6-9: Forms and Checklists

NUMBER	TITLE
F6.1	Quality Assurance Design Certificate
F6.2	Pipe Laying Checklist
F6.3	Final Inspection Checklist

F6.1 WATER RETICULATION – DESIGN CONFIRMATION

Site Address	Project Name	
Consent Number	SUB _____ / _____	LUC
Name of Developer		
Name of Designer	Name of Consultant:	
Designer's relevant qualifications		
Plan Numbers:		Revision:
Calculation Sheets attached: (list)		
I hereby confirm that the design of the water reticulation for the above site has been designed in accordance with the RITS and the Conditions of Consent.		
Signed: _____	Designer	Date: _____

Engineering Exception Decisions			
The following aspects of the design do not meet the requirements of the RITS. Note 1 : Where standards are not met, please detail the alternative standard achieved. Note 2 : The non-complying aspects will require acceptance by the Council's Asset Manager.		Accepted?	
		Y	N
Exception Item	Explanation of Alternative Standard		

Engineering Exception Decision accepted by _____
 Asset Manager Date _____

F6.2 WATER RETICULATION PIPE LAYING CHECKLIST

Site:		Developer:			
Name of qualified water service person:					
Location:	To	To	To	To	To
	From	From	From	From	From

Pipe Laying Checks

Pipe size, quality, acceptable products checked. (attach photo of manufacturer’s stamp on pipe)	<input type="checkbox"/>	<input type="checkbox"/>	<input type="checkbox"/>	<input type="checkbox"/>	<input type="checkbox"/>
Foundation support in soft soil <ul style="list-style-type: none"> • Dynamic cone penetrometer (DCP) results available • if under-cutting required, note metreage and DCP 	<input type="checkbox"/>	<input type="checkbox"/>	<input type="checkbox"/>	<input type="checkbox"/>	<input type="checkbox"/>
Valves and hydrants not in carriageway	<input type="checkbox"/>	<input type="checkbox"/>	<input type="checkbox"/>	<input type="checkbox"/>	<input type="checkbox"/>
Alignment and cover	<input type="checkbox"/>	<input type="checkbox"/>	<input type="checkbox"/>	<input type="checkbox"/>	<input type="checkbox"/>
Bedding type and backfill material. (Attach DCP results for road crossings and driveways)	<input type="checkbox"/>	<input type="checkbox"/>	<input type="checkbox"/>	<input type="checkbox"/>	<input type="checkbox"/>
All service connections in place. (Attach table of water meter and backflow preventor numbers with corresponding lot numbers.)	<input type="checkbox"/>	<input type="checkbox"/>	<input type="checkbox"/>	<input type="checkbox"/>	<input type="checkbox"/>
Connections and Toby Box correctly located horizontally and vertically (Dwg D6.6 & 6.7)	<input type="checkbox"/>	<input type="checkbox"/>	<input type="checkbox"/>	<input type="checkbox"/>	<input type="checkbox"/>
Hydrants and valves positioned correctly (Dwg D6.1-6.3)	<input type="checkbox"/>	<input type="checkbox"/>	<input type="checkbox"/>	<input type="checkbox"/>	<input type="checkbox"/>
Thrust blocks installed.	<input type="checkbox"/>	<input type="checkbox"/>	<input type="checkbox"/>	<input type="checkbox"/>	<input type="checkbox"/>
Pipelines flushed.	<input type="checkbox"/>	<input type="checkbox"/>	<input type="checkbox"/>	<input type="checkbox"/>	<input type="checkbox"/>
As-built measurements taken prior to backfill.	<input type="checkbox"/>	<input type="checkbox"/>	<input type="checkbox"/>	<input type="checkbox"/>	<input type="checkbox"/>
Pressure test witnessed and passed by Council representative.	<input type="checkbox"/>	<input type="checkbox"/>	<input type="checkbox"/>	<input type="checkbox"/>	<input type="checkbox"/>

Bacto sample taken and passed by Council representative PRIOR to connection to the live Council main.	<input type="checkbox"/>	<input type="checkbox"/>	<input type="checkbox"/>	<input type="checkbox"/>	<input type="checkbox"/>
Connection to live main by Council (unless specifically approved).	<input type="checkbox"/>	<input type="checkbox"/>	<input type="checkbox"/>	<input type="checkbox"/>	<input type="checkbox"/>
Main left charged at FAC level of _____ ppm					

Developer/Contractor _____ **Council Rep** _____
Date: _____ **Date:** _____

F6.3 WATER RETICULATION FINAL INSPECTION CHECKLIST

Site/Location:	
Developer/Contractor:	
SUB _____ / _____	Contract No:

Pre-Meeting Tasks

Developer to verify prior to meeting:	Developer Check	Council Rep Check
21. All lines flushed out	<input type="checkbox"/>	<input type="checkbox"/>
22. All backfilling complete and reinstated	<input type="checkbox"/>	<input type="checkbox"/>
23. Form 6.1 completed	<input type="checkbox"/>	<input type="checkbox"/>
24. Form 6.2 completed	<input type="checkbox"/>	<input type="checkbox"/>
25. Final as-built plans attached for site inspection	<input type="checkbox"/>	<input type="checkbox"/>
26. Connected to existing supply by Council (refer Form 6.2)	<input type="checkbox"/>	<input type="checkbox"/>

Site Meeting

27. Valves and hydrants correctly marked (Refer drawings D6.2 & D6.4 for indicator posts)	<input type="checkbox"/>	<input type="checkbox"/>
28. Pavement markers in place	<input type="checkbox"/>	<input type="checkbox"/>
29. Fire hydrant lids painted	<input type="checkbox"/>	<input type="checkbox"/>
30. Boxes installed correctly (Refer drawings D6.2 & D6.3)	<input type="checkbox"/>	<input type="checkbox"/>
31. All valves checked on/off	<input type="checkbox"/>	<input type="checkbox"/>

Remedial work required? Yes (please list) No

Developer/Contractor _____ **Council Rep** _____
Date: _____ **Date:** _____

⋮

DRAWINGS

Table 6-10: Drawing Register

DRAWING NO.	TITLE
D6.1	Typical Network Layout
D6.2	Sluice Valve
D6.3	Fire Hydrant
D6.4	Valve Indicator and Post Details
D6.5	Ridermain in a Cul-de-Sac
D6.6	20mm Metered and Unmetered Service Connections
D6.7	20mm Metered and Unmetered Multi-Service Connections
D6.8	50mm Meter Connection
D6.9	100mm and 150mm Meter Connection
D6.10	Water Connection Layouts
D6.11	Flush Out Valve Assembly
D6.12	Location of Services in Transport Corridor
D6.13	Shared Trench Standard Detail for Right of Way / Shared Accessway

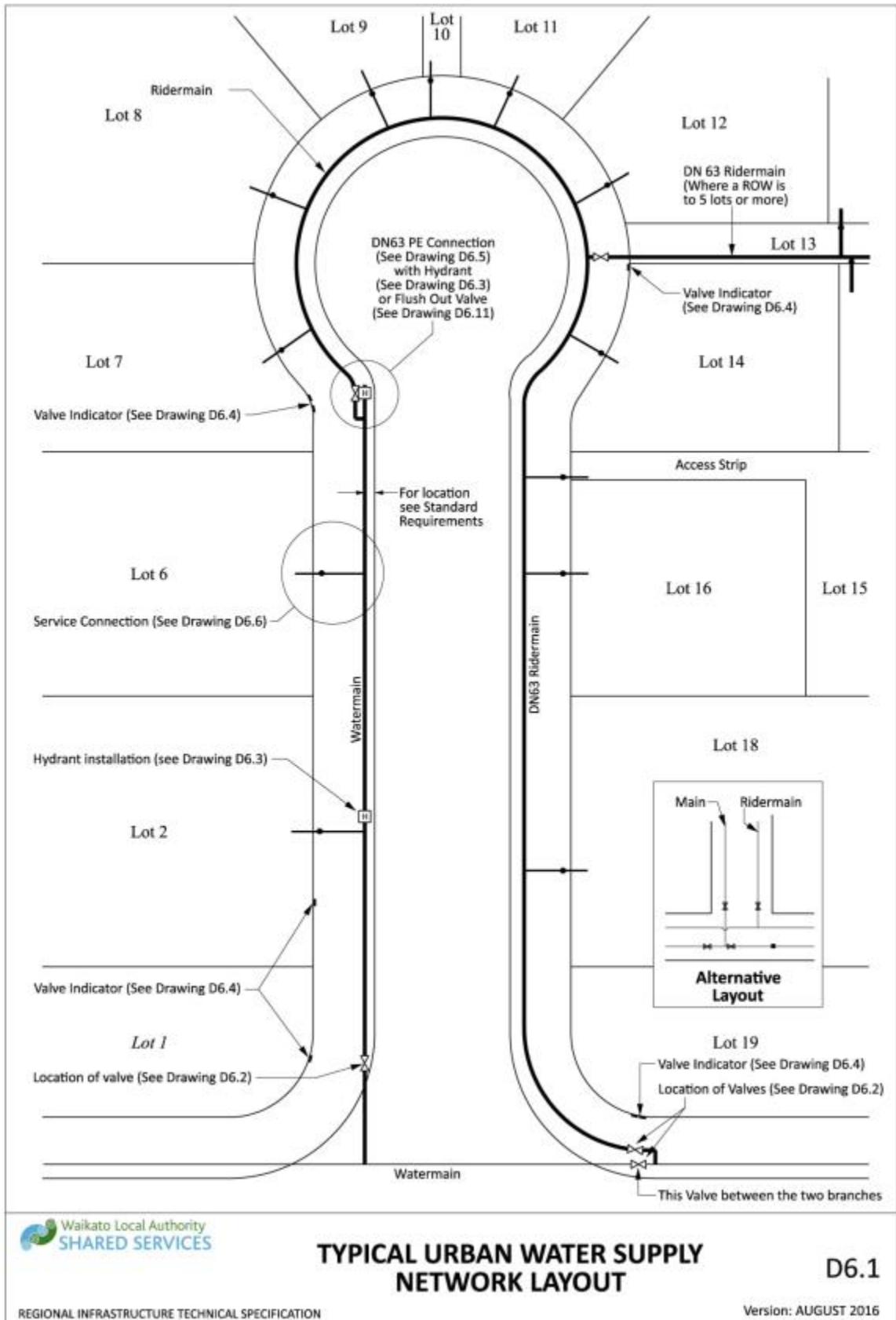

Drawing 6-1: Typical urban water supply network layout

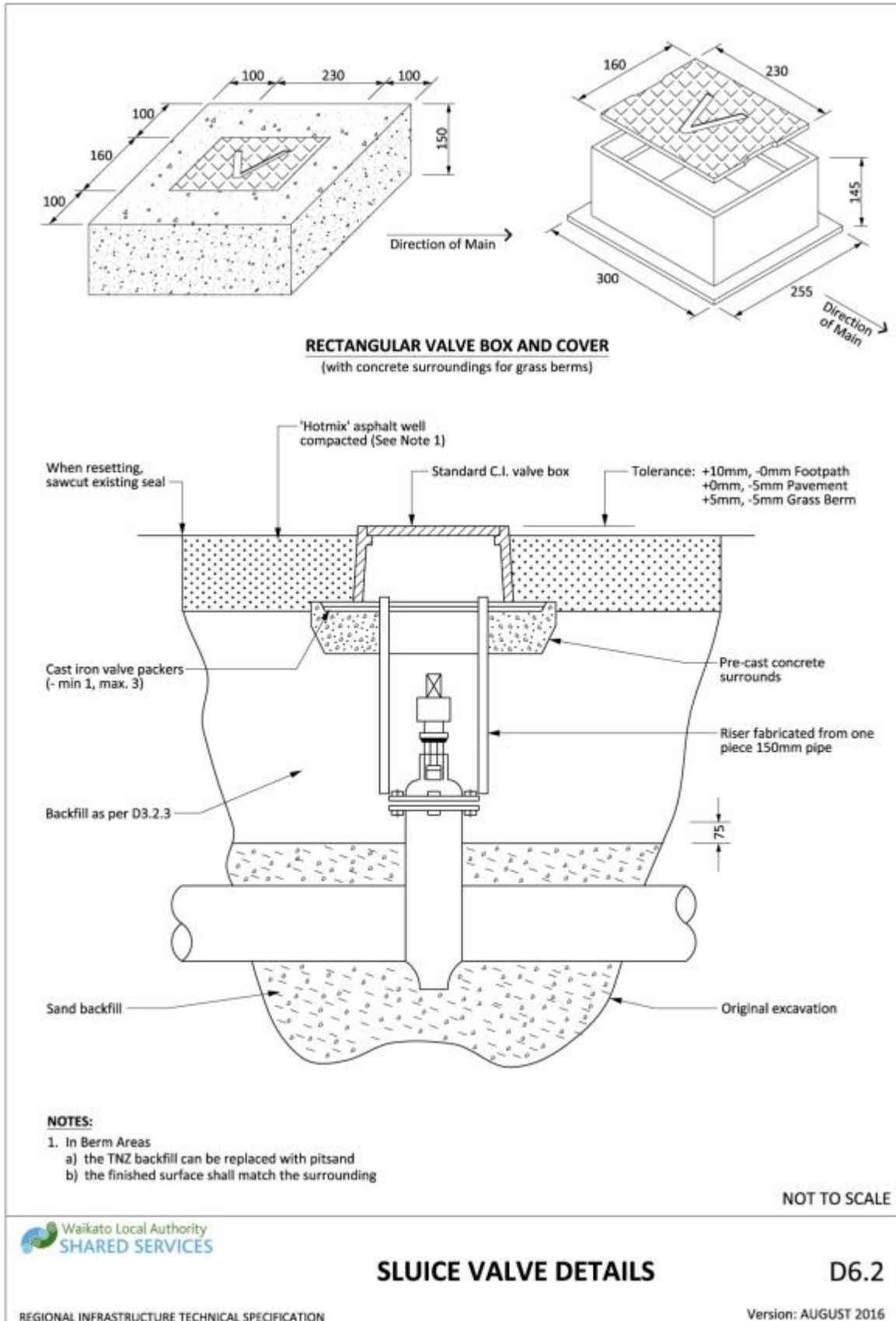

Drawing 6-2: Sluice valve details

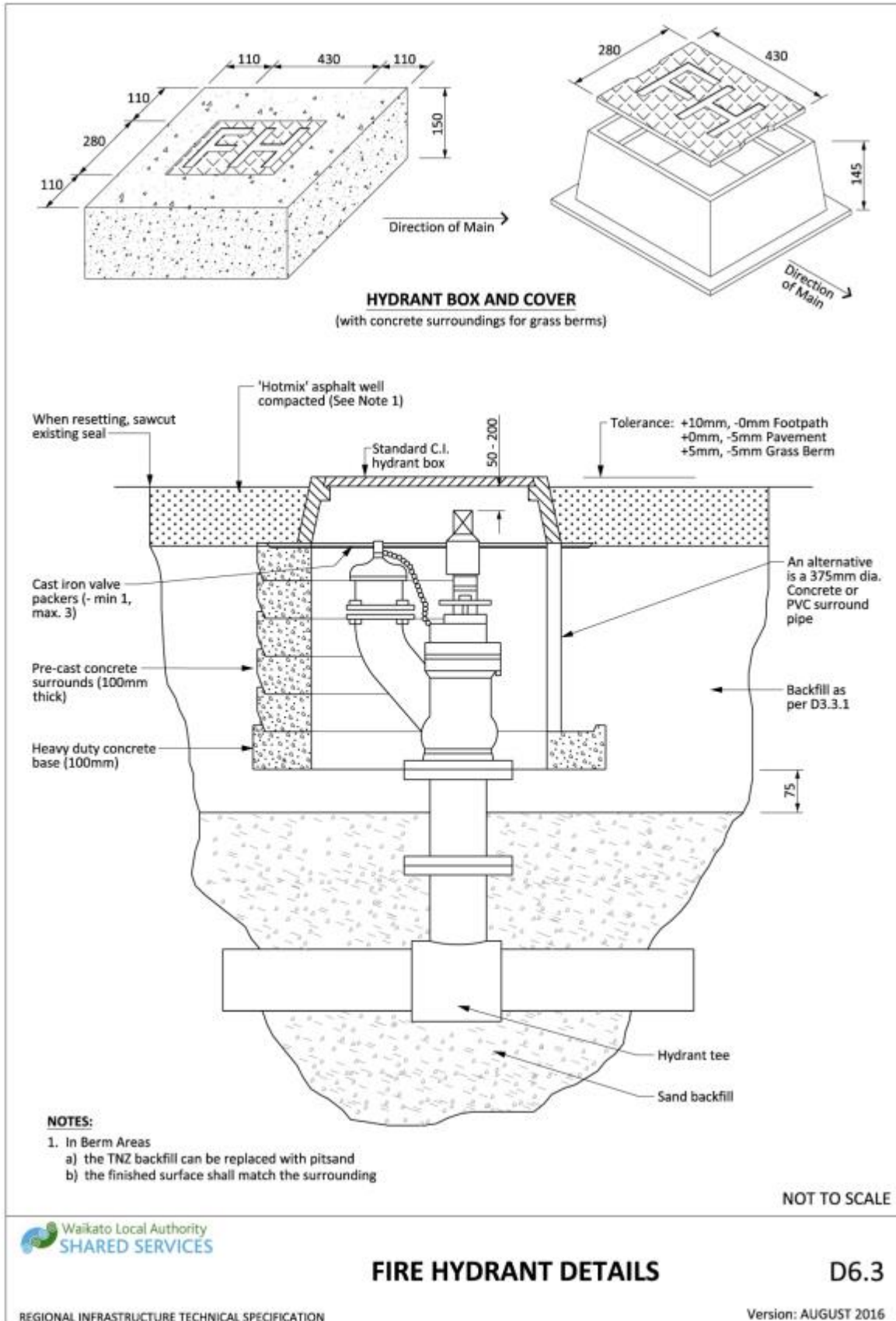

Drawing 6-3: Fire hydrant details

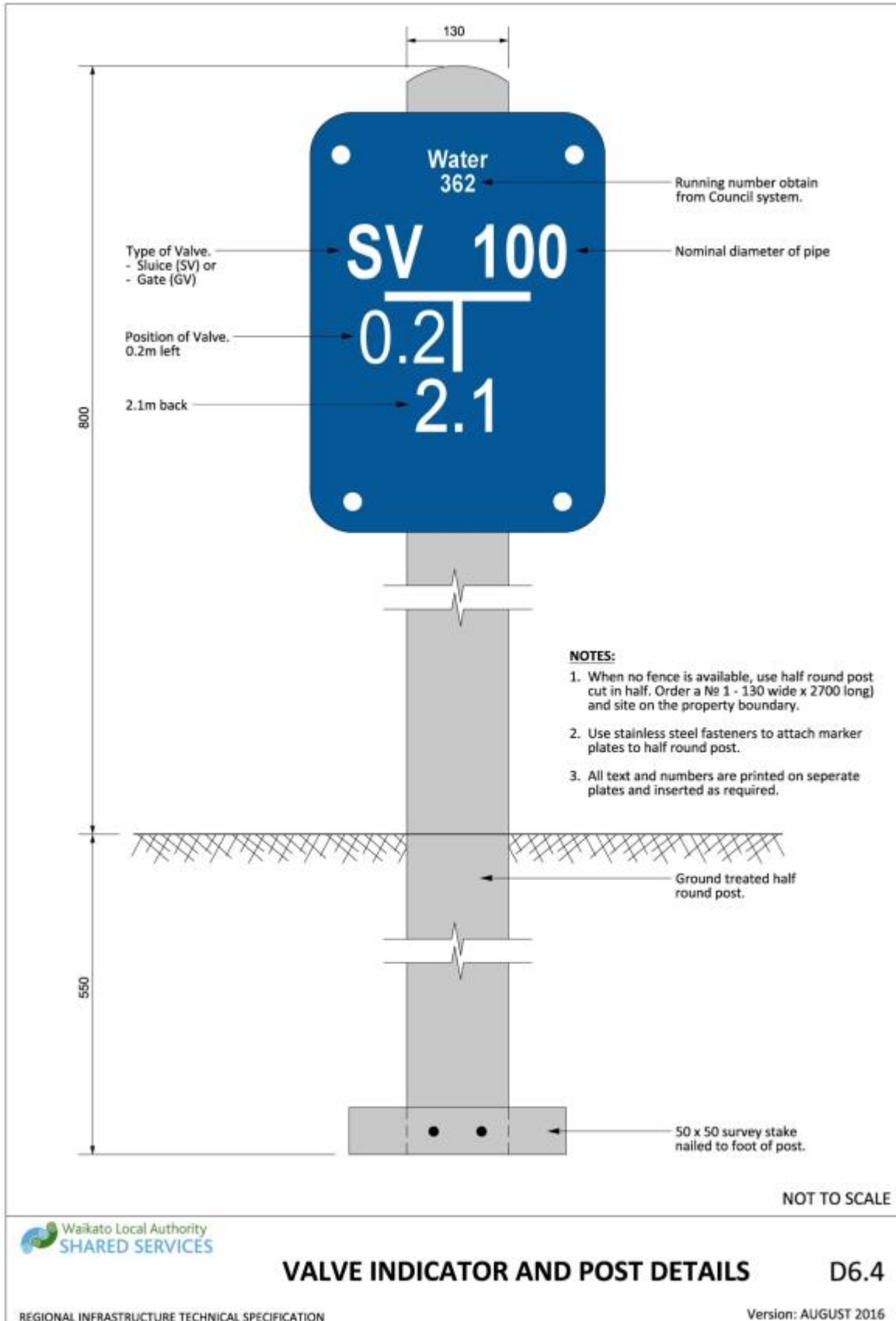

Drawing 6-4: Valve indicator and post details

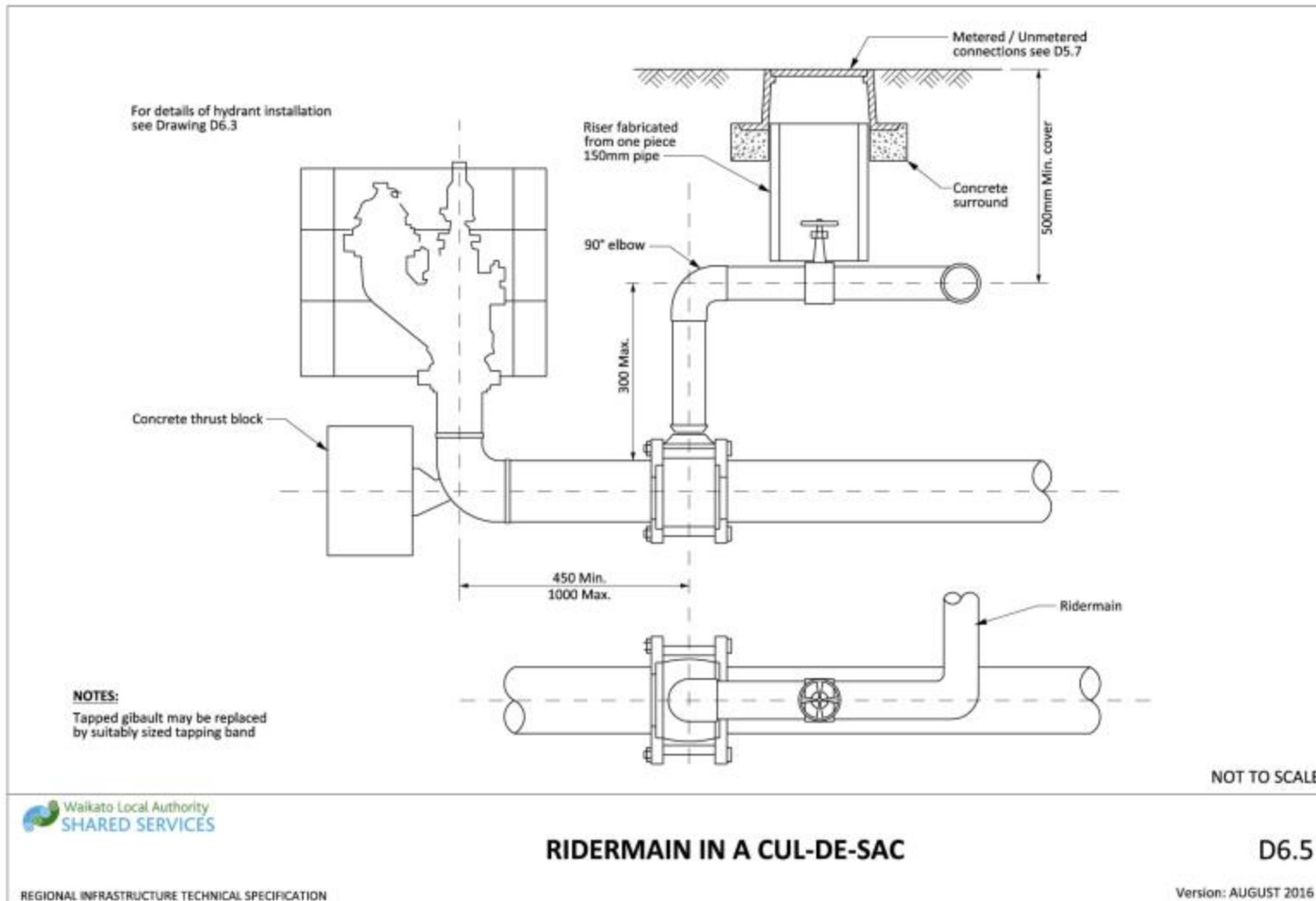

Drawing 6-5: Ridermain in a cul-de-sac

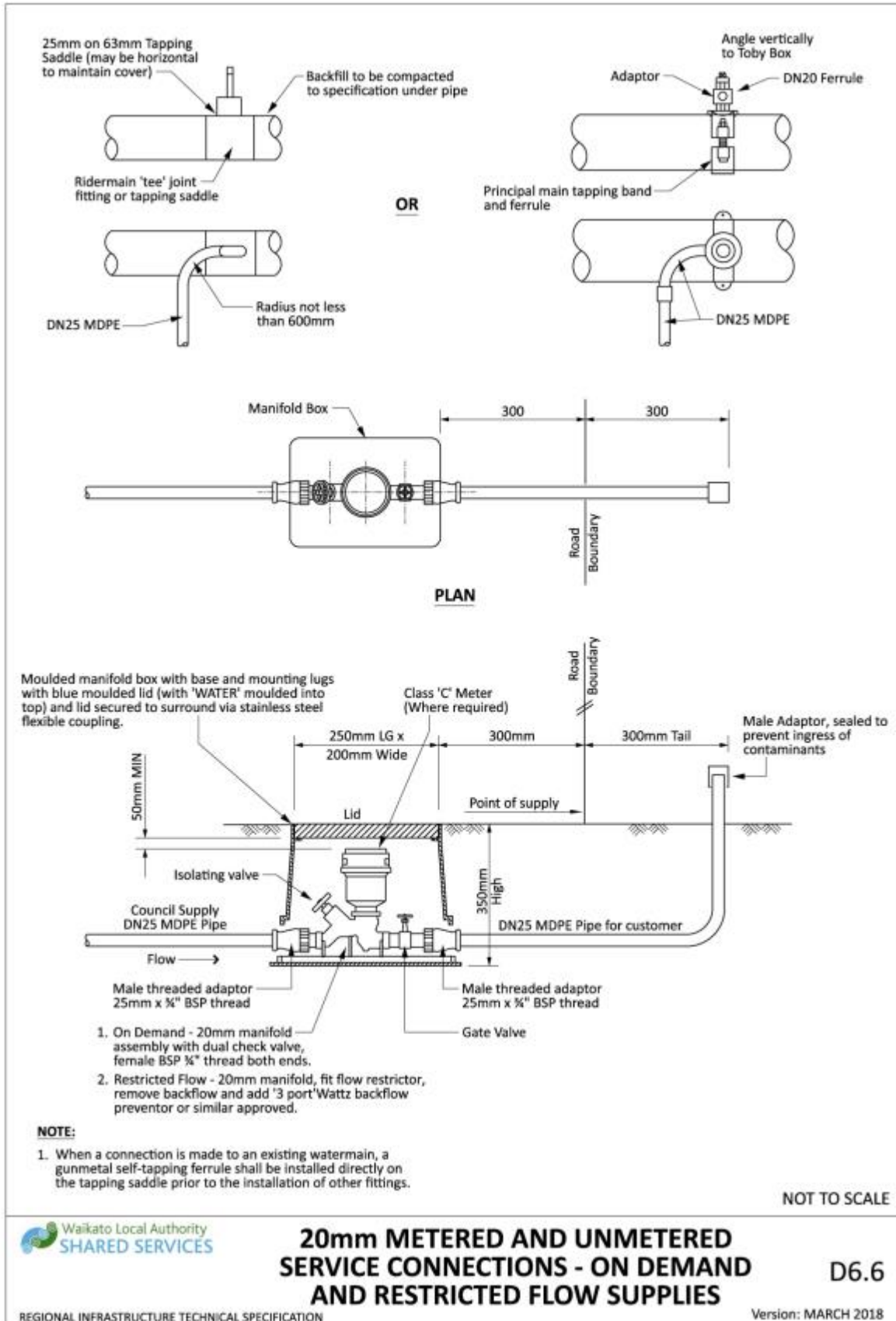

Drawing 6-6: 20mm metered and unmetered service connections - on demand and restricted flow supplies

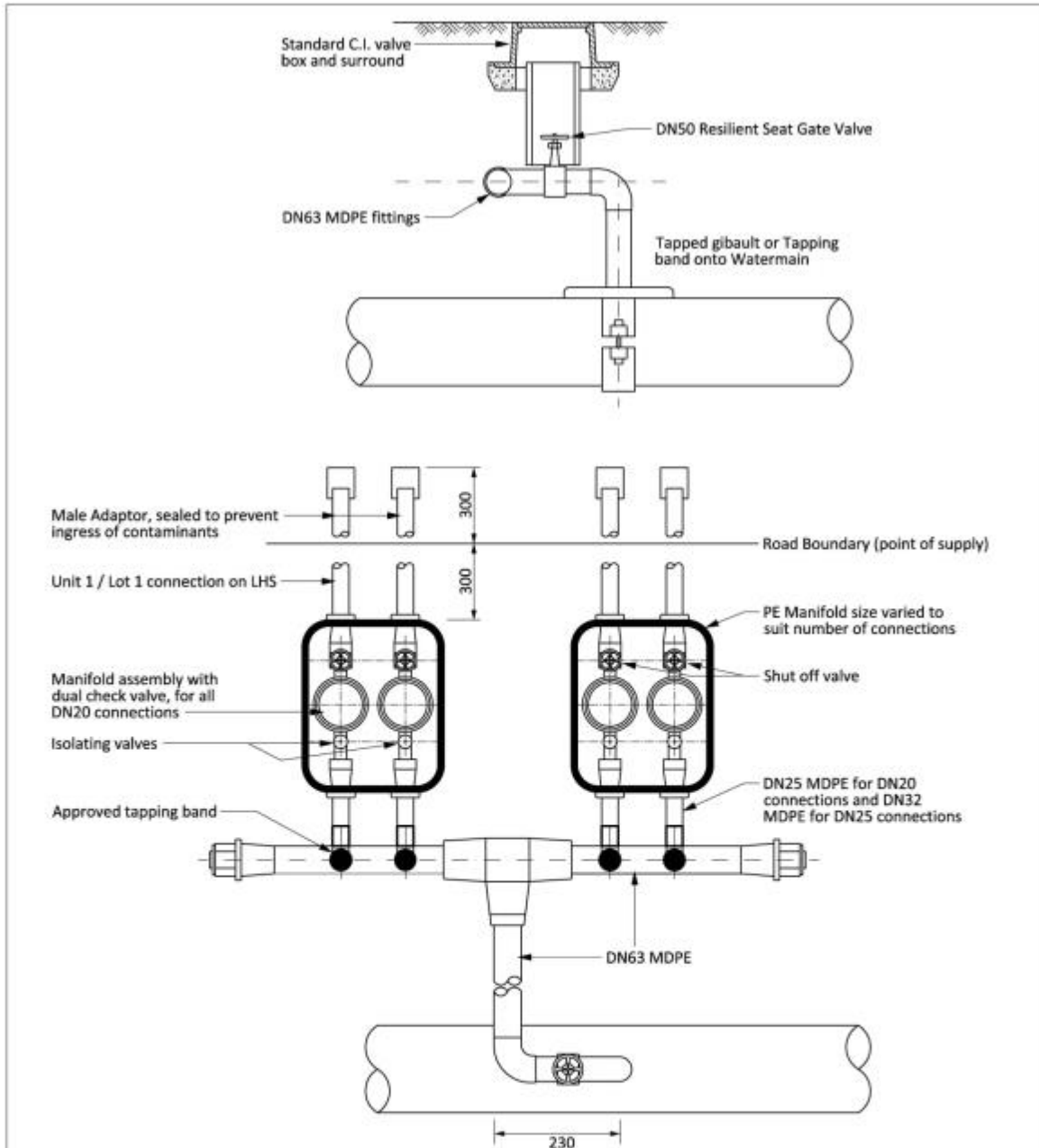

MANIFOLD ASSEMBLY FOR MULTIPLE WATER CONNECTIONS

NOTES:

1. In-line or one-sided arrangements permitted to suit site conditions.
2. Connections from rider mains to be made using 63 x 63 MDPE tee in place of a tapping band or tapped gibault. Tee to be placed horizontally to maintain standard cover.
3. Manifolds with pressure caps to be installed on all DN20 domestic connections. Meters installed on all connections serving commercial, industrial zoned lots and residential where required by Council.

NOT TO SCALE



DN20 METERED & UNMETERED SERVICE CONNECTIONS ON DEMAND

D6.7

REGIONAL INFRASTRUCTURE TECHNICAL SPECIFICATION

Version: AUGUST 2016

Drawing 6-7: DN20 metered and unmetered service connections on demand

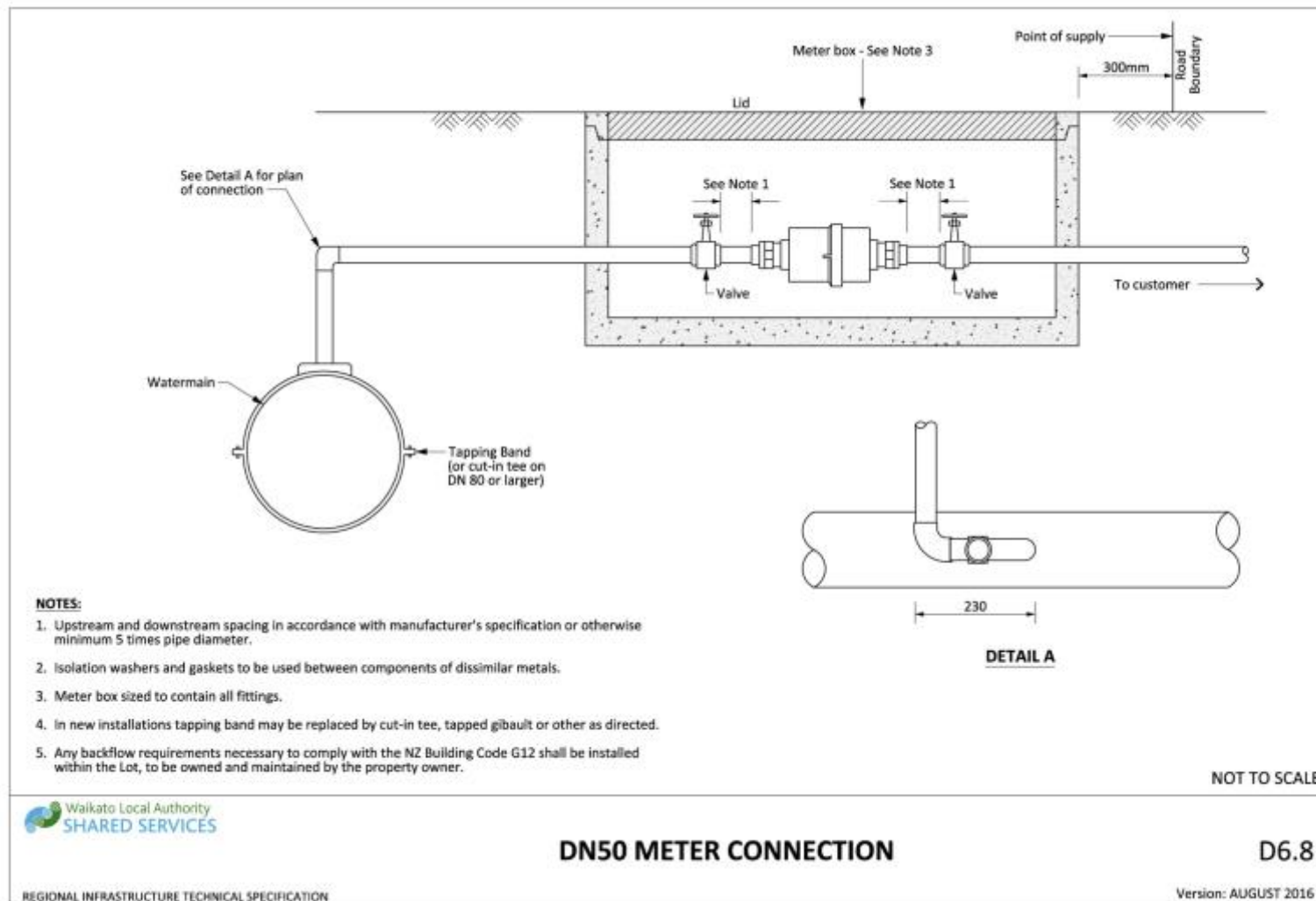

Drawing 6-8: DN50 meter connection

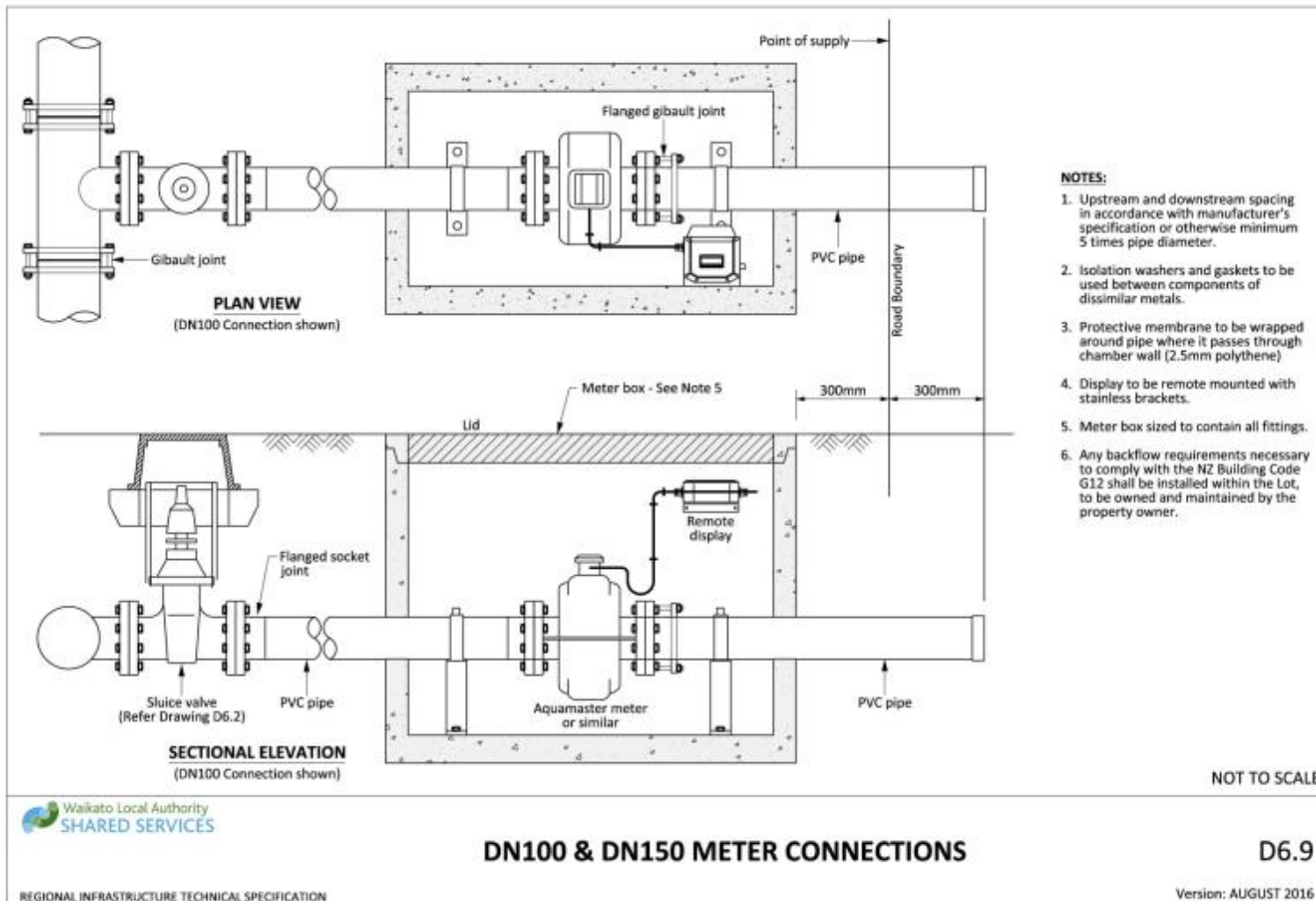

Drawing 6-9: DN100 and DN 150 meter connections

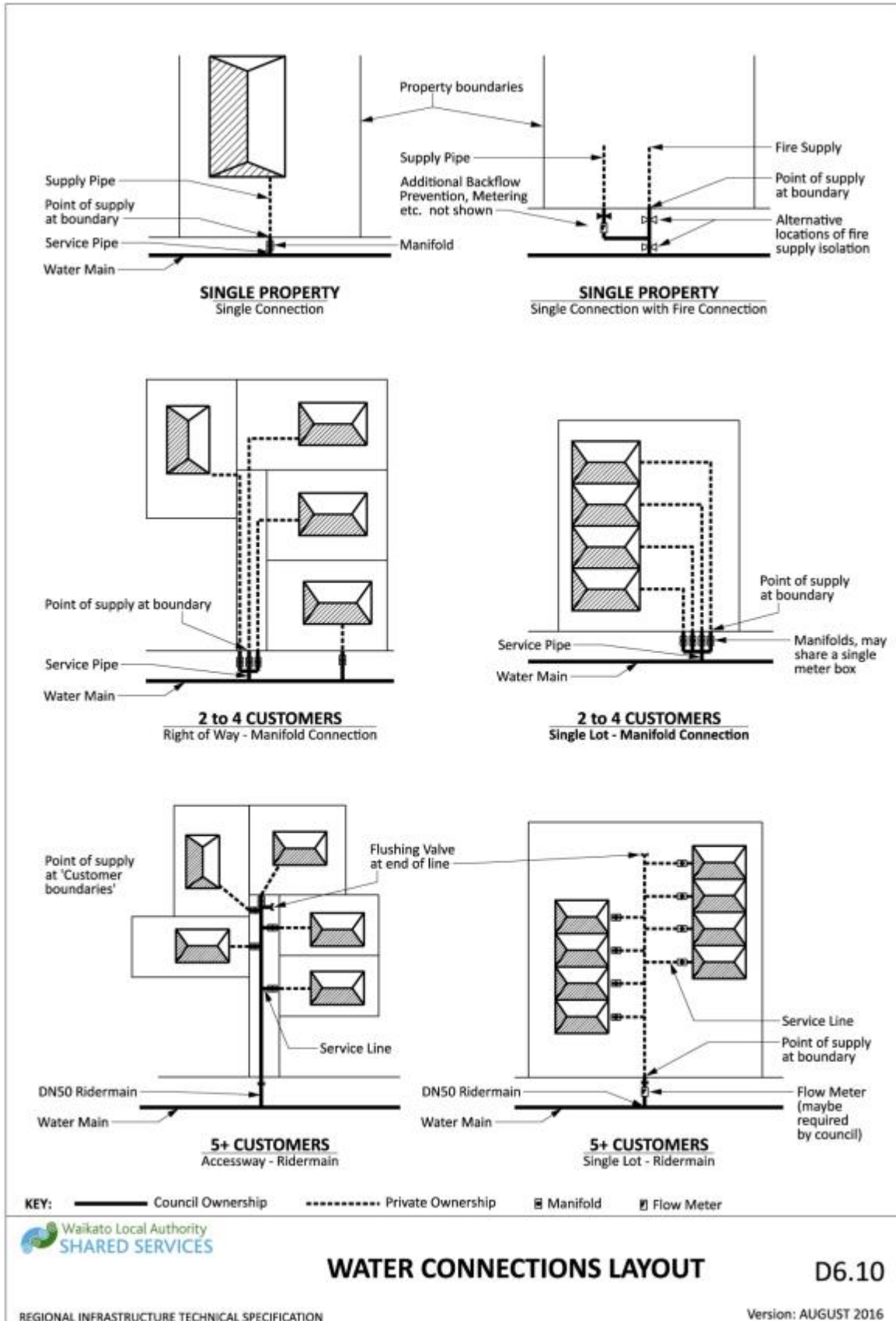

Drawing 6-10: Water connections layout

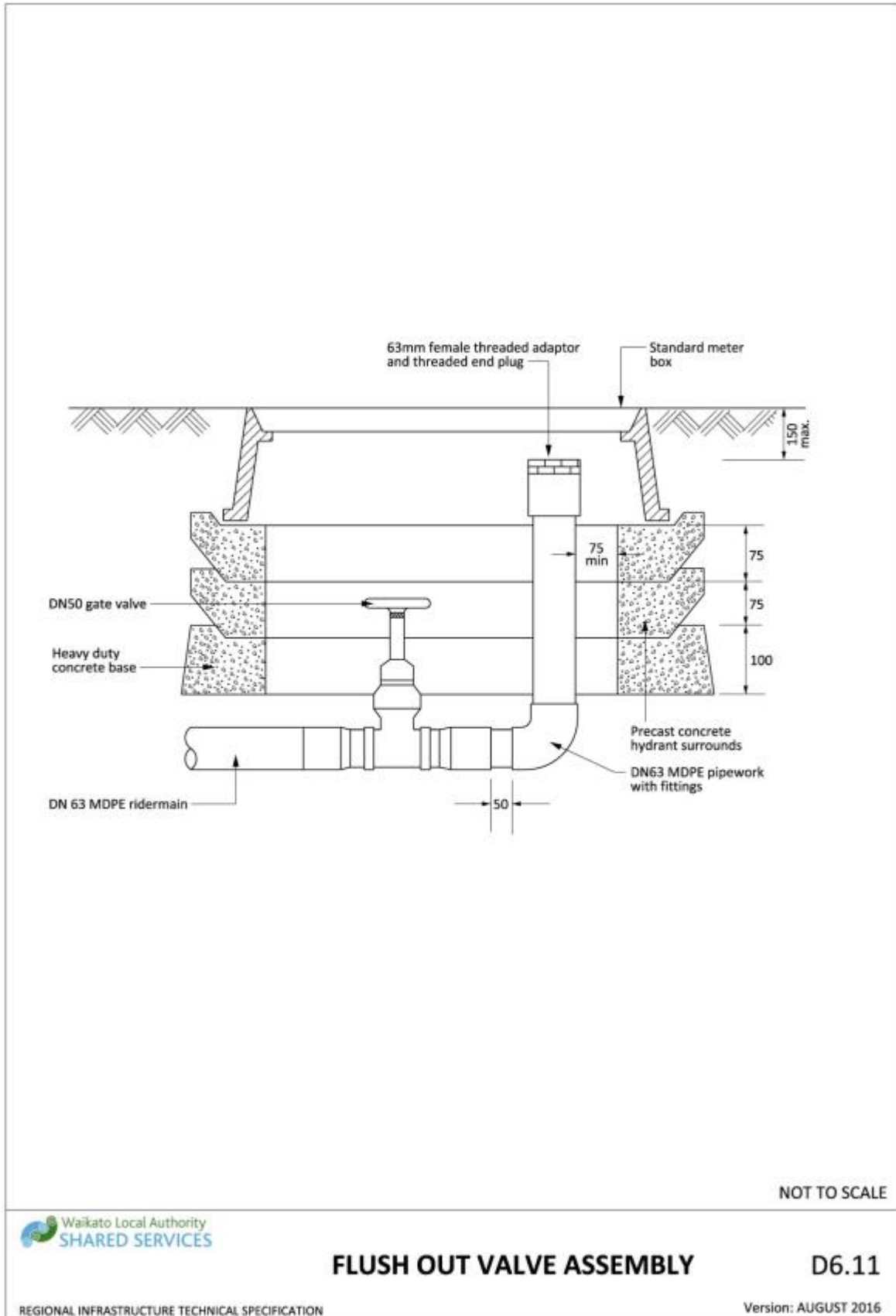

Drawing 6-11: Flush out valve assembly

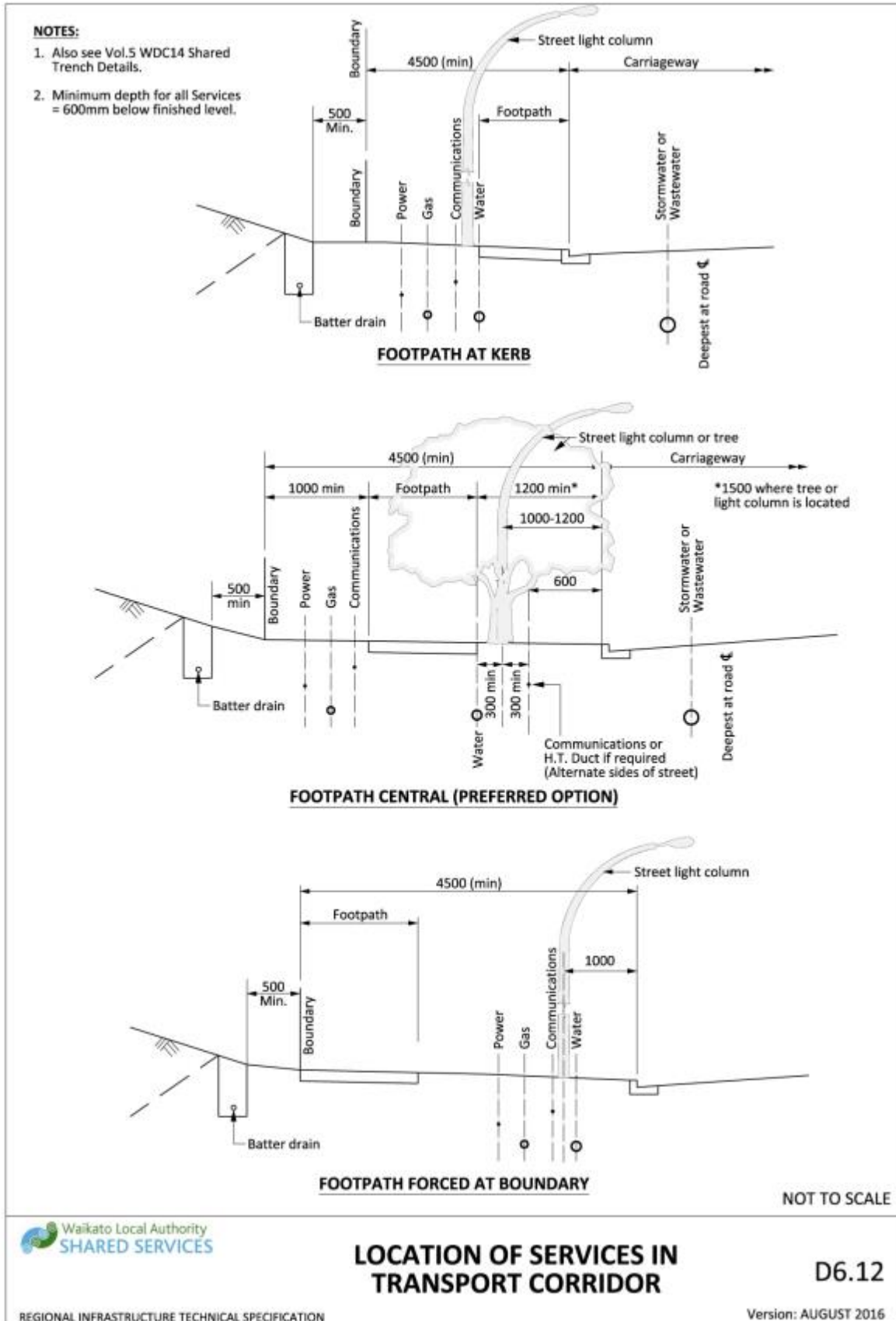

Drawing 6-12: Location of services in transport corridor

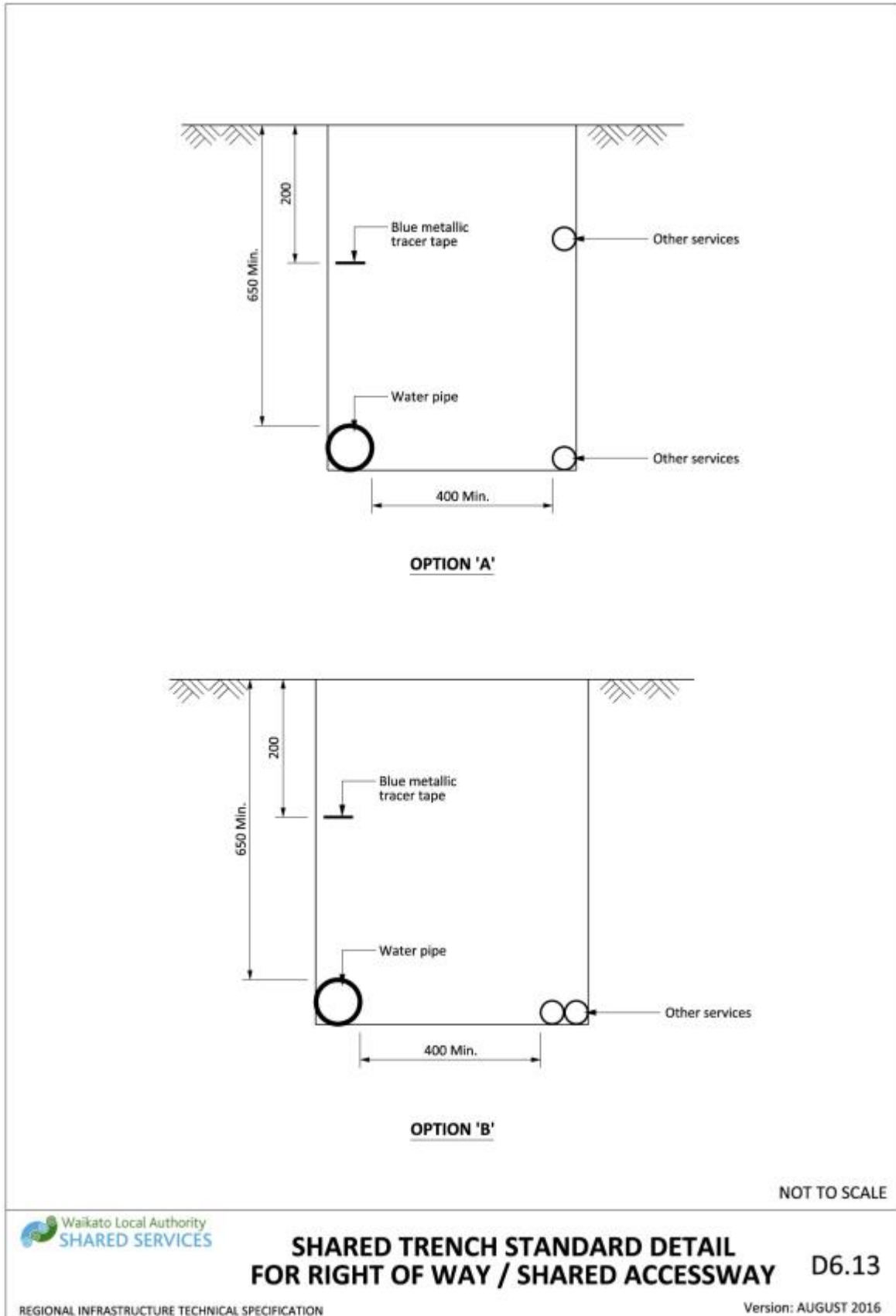

Drawing 6-13: Shared trench standard detail for right of way / shared accessway

7 LANDSCAPE

7.1	Introduction	546
7.1.1	Objectives	546
7.1.2	Reserves and Land Protection Covenants.....	546
7.1.3	Reference Documents.....	546
7.2	Design	547
7.2.1	Design Principles and Requirements.....	547
7.2.2	Crime Prevention through Environmental Design (CPTED).....	547
7.2.3	Landscape Plans.....	548
7.2.4	Access	548
7.2.5	Fencing	550
7.2.6	Lighting	550
7.2.7	Signs.....	550
7.2.8	Structure and Furniture.....	551
7.2.9	General Species Design Selection, Layout and Sourcing.....	551
7.2.10	Streetscape.....	552
7.2.11	Problematic Plant Species.....	555
7.3	Construction	555
7.3.1	Protecting Existing Vegetation and Trees.....	555
7.3.2	Reserves Specimen Tree Location.....	557
7.3.3	Site Preparation.....	557
7.3.4	Soil.....	557
7.3.5	Tree Pits.....	558
7.3.6	Grassing, Sowing and Turfing	558
7.3.7	Street Tree Planting	560
7.3.8	Irrigation and Fertilising	560
7.3.9	Quality Control.....	561
7.3.10	Weed and Litter Control.....	562
7.3.11	Mulching.....	563
7.3.12	Staking, Fencing and Protection.....	564
7.3.13	Pruning.....	565
7.4	Defects Liability	565
7.4.1	As-built Information	565
7.4.2	Works clearance Inspection.....	566
7.4.3	Defects Liability Period Final Inspection	566
7.4.4	Street Trees Defects Liability Period.....	566
7.4.5	General Planting Defects Liability Period.....	566
7.4.6	Fencing and Landscape Structure Defects Liability Maintenance	568
7.4.7	Grassing and Turf Defects Liability Period.....	568

LIST OF APPENDICES

Appendix 7A: Drawings.....	570
Appendix 7B: Plant Number Calculator.....	578
Appendix 7C: Forms	580

LIST OF TABLES

Table 7-1: Reference Documents	546
Table 7-2: CPTED Principles	547
Table 7-3: Fencing Types	550
Table 7-4: Infill Areas	553

Table 7-5: Design Criteria for Roundabouts 554
 Table 7-6: Root Protection Distances..... 555
 Table 7-7: Tree Pits Design Criteria 558
 Table 7-8: Livestock Fencing Standards 565
 Table 7-9 : Minimum General Landscape Maintenance Schedule during Defects Liability Period 569
 Table 7-10: Drawing Register 570
 Table 7-11: Forms and Checklists..... 7-580

LIST OF FIGURES

No table of figures entries found.

LIST OF DRAWINGS

Drawing 7-1: Landscape planting areas 571
 Drawing 7-2: Street tree planting clearances 572
 Drawing 7-3: Tree pits within carriageway..... 573
 Drawing 7-4: Street tree root barrier..... 574
 Drawing 7-5: Tree pits within carriageway pavement 575
 Drawing 7-6: Kerbside tree pit..... 576
 Drawing 7-7: Timber pollard post and chain..... 577

LIST OF EQUATIONS

Equation 7-1: Grass sowing rates 561
 Equation 7-2: Plant number calculator for level sites..... 7-578
 Equation 7-3: Plant number calculator for sloped sites..... 7-578

7.1 INTRODUCTION

The landscape section sets out requirements for the design and construction of landscaping and planting for land development and subdivision.

For landscape areas requiring planting and vegetation in wetlands, dry detention basins, swales, filter strips and rain gardens - refer to Sections [3 - Transportation](#) and [4 - Stormwater](#).

7.1.1 Objectives

Landscape design has application throughout the subdivision and development process. As such, it should be considered in the early stages of a development and at this initial concept stage it is important to establish objectives for overall landscape design involving the appropriate professionals to assess the natural systems, vegetation, and landscape features.

The objective of any landscape design shall:

- a) Maximise long term benefit
- b) Minimise on-going maintenance works
- c) Protect, maintain and restore existing natural ecosystems, vegetation, and landscape features
- d) Respond to the surrounding landscape character and context including cultural and heritage (including waahi tapu), ecological and geological elements
- e) Contribute to ecological and habitat biodiversity
- f) Provide amenity open space, “buffer areas”, open space connections and access to watercourses
- g) Enhance and strengthen existing character and intended future character
- h) Promote integrated neighbourhoods
- i) Use species that will quickly establish and form a weed suppressing canopy
- j) Provide a coherent design
- k) Protect and enhance existing vegetation
- l) Minimise risk to the public

7.1.2 Reserves and Land Protection Covenants

Layout plans, location of recreational reserves, streams, parks and public walkways, and land protection covenants should be discussed with the Council prior to the lodgement of finalised plans.

7.1.3 Reference Documents

Details of standards, specifications and other documents referenced in this Section are as follows:

Table 7-1: Reference Documents

NZS 5828:2015	Playground Equipment and Surfacing
---------------	------------------------------------

NZS 8409 : 2004	Management of Agrichemicals
Austrroads	Guide to Road Design Part 4A Unsignalised & Signalised Intersections, Clause 3 Part 4B Roundabouts, Fig 3.1
Fencing Act 1978	
Ministry of Justice	National Guidelines for Crime Prevention Through Environmental Design Principles in New Zealand (2005)
Ministry for Primary Industries (MP)	National Plant Pest Accord (NPPA) List
NZ Arboricultural Association	A Guideline for Tree Protection Fencing on Development Sites (2011)
NZ Arboricultural Association	A Guideline for Tree Protection on Development Sites (2011)
Waikato Regional Council	Regional pest management strategy

7.2 DESIGN

7.2.1 Design Principles and Requirements

Landscaping and planting should be designed to respond to the overall environmental context of an area such as vegetation and water bodies, cultural and heritage elements, local road geometry stormwater and reserve design, and utilities placement. Planting may include specimen trees, edible gardens, rain gardens, swales, and other amenity garden features.

Infrastructural services should be planned at the same time as the landscape design so that tree and garden planting location does not compromise the integrity and efficient operation of services and vice versa. Consideration should also be given to vegetation growth and impact on sight lines. If particular landscape conditions or objectives are required for a subdivision or development then these will need to be taken into account prior to undertaking detailed engineering design.

7.2.2 Crime Prevention through Environmental Design (CPTED)

All landscape design, irrespective of location shall ensure that CPTED principles are applied. The basic principles are:

Table 7-2: CPTED Principles

Territoriality	The physical design is used to promote a sense of ownership, respect, responsibility and community well-being.
Natural Surveillance	All areas throughout the site that are publicly accessible can be seen from other parts of the site so that people can see and be seen. Likewise, ensuring there are no visually closed entrapment areas.
Access Control	The site has well-defined routes, spaces and entrances that provide for convenient movement without compromising security.
Space Management	The site has an appropriate use of space, is well-cared for, attractive and has vandal resistant facilities and buildings.
Activity Support	The site promotes positive human activity that is appropriate to the location.

7.2.3 Landscape Plans

Refer to the relevant District Plan for specific Site Plan and Landscape Plan requirements. In conjunction with these requirements, accompanying information to be included for approval by Council includes:

- a) A Statement of Design Intent and Design Objectives.
- b) A Plant Schedule, detailing proposed plant species (botanical and common names), the centres/spacing's, and plant grades and quantities.
- c) A plan showing existing trees and vegetation (refer 7.3.1).
- d) Technical Specifications for landscape implementation if they deviate from this RITS. If specifications are not provided, Council assumes the developer will abide by this RITS and shall be assessed accordingly.
- e) Local purpose reserves will require a complete plan, not just landscaping.
- f) A Landscape Maintenance Schedule that will be applied during the defects and liability period.

7.2.4 Access

Connecting existing reserves, accessways and open spaces provides routes and return loops for recreational use. They also encourage sustainable transport choices by allowing for continuous off-road journeys. These can provide more direct routes to destinations than vehicular routes and encourage a more healthy access alternative. Connections can also create larger open space areas and add recreational amenity value (walkers and runners prefer a loop to a dead end).

Consideration should be given to how the development will link to the surrounding landscape including existing areas of open space, and to other public areas, such as schools, town centres, community facilities or public transport routes. Neighbourhood Parks should be accessible to all surrounding neighbourhoods and communities.

7.2.4.1 Pedestrian/Cycle Access

Generally paths in reserves and on accessways to reserves are required to be three metres wide to allow for shared use by pedestrians and cyclists and should be straight and direct according to pedestrian desire lines, in order to provide long lines of sight and reduce the potential for entrapment.

Ensure there is a clear space buffer on either side of paths of at least one metre between the height of 500mm to 2.4m to ensure adequate visibility for pedestrians and cyclists. Furniture should be set back at least 1m from paths, whilst still providing for connectivity and access for people with disabilities (such as wheel chair and mobility scooter users), and any plant species should be selected so that future growth will not encroach into the clear space buffer. Groundcovers may be planted within the clear space buffer, at a minimum of 400mm setback from the path edge, as long as the mature height is no more than 500mm and the plant(s) do not encroach over the path edge.

Pedestrian/cycle accessways should have an easy gradient (maximum 1:12 where practicable) and avoid steps where possible to allow for cycle and mobility vehicle use. Where steps are required then a half-round open concrete channel should be formed adjacent the steps to assist cycle movement.

Consider the location of the path and plantings on reserve accessways to ensure the path receives maximum sunlight hours in winter and that any planting avoids the ability to create damp and cold pathway conditions, which could in turn lead to frosting and ice.

Path and track construction standards shall be considered in conjunction with the standards set within the Transportation Section to enable vehicle access for maintenance purposes.

For further information in relation to pedestrian and cycle access, please refer to the relevant District Plan and Transport Section.

7.2.4.2 **Vehicle Access**

Generally vehicle access will be installed by the applicant prior to the vesting of the reserve. Vehicle access points are required for vehicles to undertake mowing, rubbish collection, maintenance and for emergency vehicles. Vehicle access points must be wide enough to allow for heavy machinery (minimum 4m). Vehicle crossings must comply with the Transportation Section.

Access roadways and off-street parking may be required for reserves such as sports parks, amenity parks, horticultural parks, the starting point of walking tracks and neighbourhood parks receiving high-use or serving a regional function. Consult with Council to see if parking areas and access roadways are required. The design and construction of roadways, parking areas and vehicle crossings must comply with the Transportation Section.

7.2.4.3 **Vehicle Barriers (to prevent vehicular access)**

Where required, measures to prevent unauthorised vehicle entry will be installed by the applicant prior to vesting of the reserve. Where possible planting and landscaping should be used.

Where vehicle barriers are required to control unauthorised vehicles, this may be in the form of a standard non-mountable kerb, a physical vehicle barrier or bollards. Vehicle barriers should meet the following objectives:

- a) Prevent vehicles from accessing reserve land
- b) Continue to allow pedestrian and cycle access
- c) Be of a design that ensures consistency with other reserve structures and furniture
- d) Does not adversely affect the visual amenity of the area
- e) Does not greatly increase maintenance requirements
- f) Able to withstand or discourage vandalism pressure
- g) Where bollards are required the standard wooden bollard (see [Drawing D7.7](#)) shall be used on road frontages to reserves (other than entrances). They should be spaced 1.5m apart, or 3m apart if using a connecting chain.
- h) Bollards should be placed to allow for easy mowing and maintenance and incorporate a mowing strip, as shown on the drawing.

7.2.5 Fencing

All reserves should contain adequate covenants or fencing agreements, to ensure Council is not responsible for any fencing costs on reserve boundaries.

Refer to the Fencing Act 1978 or the relevant Council's District Plan and/or Fencing Policy for any clarification.

7.2.5.1 Standard Types of Fences

Fencing will need to comply with CPTED requirements and Council's District Plan and fencing policy. Over height fences will also require a building consent from Council.

Table 7-3: Fencing Types

STANDARD PALING FENCE	A paling fence at least 1.0m high, posts 100 x 75mm and placed not more than 2.75m apart. There should be two rails (three if the fence is higher than 1.0m), with sawn timber palings placed upright and well nailed to both rails, with a gap of no more than 40mm between palings ²⁴ . All rails and palings should be tanalised to H3.1 or H3.2 and the posts to H4.
CLOSE BOARDED FENCE	The same sizes and wood treatment as the paling fence but with the boards butted closely ²⁵
SEVEN WIRE FENCE	A seven-wire fence, properly strained, the wire to be 12.5 H.T. galvanised or similar. The posts are to be concrete or H4 treated timber placed no more than 4m apart, and the battens or droppers should be of treated timber, metal or plastic, evenly spaced, and at least three between posts. The top wire is to be at least 1000mm from ground level, and no barbed wire is to be used
MESH FENCE	As for the seven wire fence, but without battens and all wires except the top, middle and bottom ones replaced by 75mm galvanised chain link mesh fixed to the wires at every second mesh row
LIVESTOCK FENCE	Refer Section 7.3.12.2.
POOL FENCE	The fence must be of a style and height such as the Steel and Tube Hurricane 'Pool fence' and complies with the Schedule in the Fencing of Swimming Pools Act

If the fence is to be painted, the colour shall be as specified by the relevant Council.

7.2.6 Lighting

Refer to the relevant District Plan and Transportation Section.

7.2.7 Signs

Signs will be installed by Council following vesting of the reserve.

If street signs are required refer to Clause 3.3.11 of the [Transportation Section](#).

²⁴ The District Plan may require a 50% visibility and so this spacing may not comply

²⁵ The District Plan may require a 50% visibility and so this spacing may not comply

7.2.8 Structure and Furniture

Provision of any structure or furniture shall be designed in accordance with the relevant Council's plans and/or policies and follow CPTED principles.

7.2.8.1 Play Equipment

Play equipment may be required to be installed by the developer, or Council may decide to install the equipment following the vesting of the reserve. The Council's objective is to provide interesting playgrounds that meet the needs of the local community. Any equipment and surfacing installed shall comply with NZS 5828. In addition all the equipment and surfacing shall meet the requirements of required building or resource consents. All play space design shall be approved by Council prior to installation.

7.2.8.2 Landscape Structures

Landscaping structures include (but are not limited to) sculptures, walls, fences, screens, bollards, tree cages and grates, entranceways, and posts. The materials should be robust to suit their purpose and ideally reflect the local character. Durability and maintenance requirements shall be considered.

Entranceway wall structures shall be located fully on private land or recreation reserves. Any other immovable landscape structure (for example boulders) shall be located to prevent obstructing access to underground services.

Structures shall be designed to safely withstand appropriate loadings. Structures not exempt under the Building Act shall only be constructed on receipt of a building consent. Code compliance certificates will be required for all structures that require a building consent.

All retaining walls, including those not requiring a building consent, should be constructed to resist lateral earth pressures, including those from any surcharge loading that may be present. They should be located wholly within private land, or recreation reserves.

7.2.9 General Species Design Selection, Layout and Sourcing

7.2.9.1 General Species Selection

In selecting species for planting, the overall composition, level of maintenance, longevity, and the need to comply with Council's planting policies are to be taken into account. The Council maintains a register of suitable species for local conditions. Consideration should be given to provide a balance of native and exotic plants to give year round interest and seasonal variances.

The following matters shall be considered:

- a) Suitability of eco-sourced native plants for re-vegetation planting of the ecological region to protect the local biodiversity
- b) Suitability to environmental conditions, for example climate, ground moisture, wind, and shade
- c) Tolerance to high foot traffic use where appropriate
- d) Pest and disease resistance

- e) Potential to become invasive – refer Regional Pest Management Plan.
- f) Non-suckering habit
- g) Final height, form, longevity, and potential impact upon neighbouring properties, structures and infrastructure
- h) Maintenance requirements
- i) Safety such as toxicity of leaves, flowers, seeds, and bark in areas likely to be used by young children, along with impairments to pedestrians
- j) Plants considered to be short lived, frost tender or high maintenance should be avoided in areas other than re-vegetation ecological areas.

7.2.9.2 Plant Numbers

Refer to [Appendix B](#) to calculate plant numbers for level sites and slopes.

7.2.10 Streetscape

Landscaping within a road reserve is otherwise known as streetscaping. This applies to all proposed road reserve landscape design or works in any part of the Transportation Corridor (in respect to both existing and proposed roads, including any subdivision or where required as a condition of subdivision consent). For design purposes refer to the relevant Council's streetscape strategy or policy.

For transportation corridors where speeds are greater than 50km/hr, landscape design is to take into account potential for errant vehicles to strike objects and landscape which increases the likelihood of crash severity. Frangibility of proposed trees and features is to be considered.

7.2.10.1 Visibility Splay Requirements

Driver sight distances need to relate to traffic function and vehicle speeds, and as such tree and streetscape planting should not be placed in the visibility splay. The achievement of relevant Austroads Criterion is desirable (see References).

In front of low intersection sign boards, planting shall be designed to be not more than 300mm high at maturity or these areas are to be paved to ensure compliance with visibility splay requirements.

7.2.10.2 Traffic-Calming and Shared Space Environments

All traffic calming and shared space initiatives must be approved by Council.

Traffic Calming

From a traffic-calming perspective, landscaping helps to reduce vehicular speed by reducing the perceived openness of streets, signals where an area is not intended to be traversed or moved through, and indicate where traffic-calming initiatives have been implemented.

When landscape planting is used in this context, vegetation is intended to visually block, reduce or impair motorist's line of sight, either along the carriageway berms or within the carriageway. The mature height of the vegetation will therefore be according to the traffic engineering specifications instead of normal carriageway landscape specifications.

Other considerations include.

- a) Ensuring there will be sufficient drainage (and water reticulation) for new landscaped traffic calming devices to be installed in existing carriageways
- b) Ensuring that existing infrastructure (such as underground piping, cabling, Aqua Cells etc) will not be compromised by the plant roots
- c) Maintenance requirements (including the establishment of traffic management plans)
- d) Landscape replacement costs should a traffic calming device be traversed by a motorist
- e) Proximity to other services such as lighting columns and utilities
- f) Signage, bus stop and pedestrian crossing (formal and informal) visibility
- g) CPTED principles, especially passive surveillance
- h) Using the appropriate plant species for the traffic engineering, ecological, sense of place and amenity requirements

Shared Space Environments

Landscaping in shared space environments is intended to reduce speed, through measures such as reducing forward visibility and introducing a horizontal deflection to create a meandering route through the space. This is especially useful in long straight streets; however, pedestrian and motorist visibility should not be reduced to impair safety for either.

7.2.10.3 Minimum Design Requirements

A service-free corridor for landscaping purposes, of a minimum 1100mm wide shall be located within the berm on both sides of the road. See [Drawing D3.1.3](#).

Unless otherwise stated by the relevant District Plan, street trees are to be planted at an equivalent rate of one tree per residential property although groups of trees may be approved where the kerb line and location of services allow for local features. Alternative tree planting areas shall be provided where streets are narrow or such a corridor cannot be provided. Alternative areas are equivalent to 1.0m² per metre of street length with any one area having a minimum site area of 12.0m². Areas protecting existing trees may be accepted as contributing to dedicated tree planting areas.

Typically, tree planting locations should conform to those shown on [Drawing D7.2](#).

Design of streets may include kerb extensions for intersections and speed controls which allow non-standard tree planting where utilities are not a problem and visibility requirements are designed to incorporate planting as a means of slowing traffic.

Traffic Islands and Berms

Design of planting in traffic islands, splitters and median strips shall be in accordance with the following table.

Table 7-4: Infill Areas

PER INFILL AREA	SURFACE APPLICATION
Infill Area less than 6m ²	Hard Surface – concrete or decorative hardstand

PER INFILL AREA	SURFACE APPLICATION
Infill Area more than 6m ²	Approved Landscaping
Internal Kerb to Kerb Width less than 1500mm	Hard Surface – concrete or decorative hardstand
Internal Kerb to Kerb Width more than 1500mm	Approved Landscaping

Roundabouts

Design of planting on roundabouts shall be in accordance with the following table:

Table 7-5: Design Criteria for Roundabouts

DESIGN CRITERIA	
Visibility Splay Austroads Criterion 2 Areas (see 7.1.3 References)	Groundcovers and bedding should not exceed 300mm in height although these may vary depending on road grades and levels
Visibility Splay Austroads Criterion 3 Areas (see 7.1.3 References)	Groundcovers and bedding should not exceed 400mm in height although these may vary depending on road grades and levels
Roundabouts: More than 12m Diameter	These roundabouts are to have at least 65 % of the internal area planted with approved intersection plant species while ensuring that visibility splays, frangibility requirements and utility services remain uncompromised. Centralised trees can be included, subject to approval. In alignment with the RRPS tree framework, the centre shall be planted with taller approved shrub and tree species to aid in slowing traffic and act as a visual nodal reference
Roundabouts: Between 6-12m Diameter	These roundabouts may be planted with up to 50% of the internal area in-filled with low groundcovers or shrubs, otherwise they are to have a Council-approved hardscape application such as paving, concrete, concrete embedded with rocks Centralised trees can be installed subject to approval.
Roundabouts: Less than 6m Diameter	These roundabouts are to have a Council-approved hardscape application such as paving, concrete, concrete embedded with rocks

7.2.10.4 Street Tree Layout

Unless otherwise stated all street trees are to be centrally located within road berms. All trees are to be planted a minimum of:

- 3.0m from any driveway
- 8.0m from any light stand
- 20.0m from any intersection
- 5.0m from any bus stop or school speed sign
- 1.5m from underground services (ideally)
- Or any other location that causes a safety concern

For Street Tree Clearances, Refer [Drawing D7.2](#).

All service locations shown on the planting plans are to be used as an indicative guide only. All services shall be located on site and any damage repaired or mitigated.

7.2.10.5 Tree Pits

Refer to Drawings [D7.4](#), [D7.5](#) and [D7.6](#) for tree pits that are installed within existing carriageways. Carriageway tree pits require additional design consideration such as frangibility, tree root intrusion into base material, the possibility of the tree drowning in a confined root space – or obtaining insufficient water. Optimum species would be those with a ball root system or those which have a deep rooting habit with minimum surface roots. Species will be site specific according to conditions and soil type.

7.2.11 Problematic Plant Species

Some Councils may maintain a list of plant species that are not to be planted in their parks, reserves or road reserves. Check with the relevant council.

7.3 CONSTRUCTION

Following construction standards and recommended procedures will ensure that all landscaping is to an acceptable standard prior to final inspection and release of the bond (if a bond is required).

It is the Developer/Contractor responsibility to ensure that the landscaping meets these required standards at the termination of the maintenance period. The developer/contractor is responsible for the routine maintenance and replacement of the planting, including dead wooding, weed control, mulching, replacing dead trees, shrubs, and plants, and watering for the period from planting to the issue of a section 224 completion certificate under the Resource Management Act or contract maintenance period.

7.3.1 Protecting Existing Vegetation and Trees

7.3.1.1 Root protection zone

The minimum area required to ensure that a tree’s health and stability is safeguarded, can be calculated using the following table:

Table 7-6: Root Protection Distances

TREE AGE	VIGOUR	METRES
Young trees (where the age of the tree is less than 20% of life expectancy)	Good vigour	6 x DBH*
	Poor vigour	9 x DBH
Mature trees (where the age of the tree is between 20% and 80% of life expectancy)	Good vigour	9 x DBH
	Poor vigour	12 x DBH
Over mature trees (where the age of tree is greater than 80% of life expectancy)	Good vigour	12 x DBH
	Poor vigour	15 x DBH

*DBH means Diameter at Breast Height which in NZ is diameter at 1.4m high (the diameter of the stem 1.4m above ground level).

7.3.1.2 Below Ground Works

If installation is required under existing trees and vegetation then trenchless technology should be considered. If this is not practicable, advice from a qualified arborist is required to minimise damage to the vegetation.

No works are to commence within 30m of historic/protected or notable trees without written approval from Council's parks staff. Council may require that an arborist monitor works in or around these trees.

7.3.1.3 Assessment Prior to Works

Prior to undertaking any work within the dripline of retained vegetation an on-site assessment of the work proposed shall be undertaken by the Arborist and those areas where supervision by the arborist is necessary.

Where heavy machinery would be operated, driven or sited within the dripline of any retained tree temporary protective fences shall be erected between the tree and the work area so as to protect the tree from damage. The position and composition of the protective fences shall be established prior to works commencing, and once erected, approved by the Arborist prior to the commencement of any site construction works. The temporary protective fences shall be strong and appropriate to the degree of construction works taking place on the site. The protective fences shall be a solid barrier which cannot easily be picked up and moved. The protective fence shall be at least 1.5m high.

No works, storage of materials, cement/concrete washings and leaching of chemicals, trenching or alteration of soil grade shall occur within those areas demarcated by a temporary protective fence. The temporary protective fences shall remain in place throughout the duration of the construction works. The position of the protective fence shall not be altered without the prior consent of the Arborist.

7.3.1.4 During Works

Within the root zone of retained trees:

- a) The removal of any existing footpath, kerb and channels, when within the root zone of retained trees, shall be carefully undertaken so as to cause no more than minor damage to the retained trees.
- b) All roots of greater than 35mm in diameter shall be carefully worked around and protected. No such roots shall be removed, except:
 - (i) where no practicable alternative to removing the root exists and;
 - (ii) where this would have a no more than minor detrimental effect on the tree and this is the supported professional opinion of the Arborist.

Any such removal shall be undertaken by the Arborist.

- c) Exposed roots of greater than 50mm shall be covered with 50mm of sand and rootzone areas shall be immediately covered with a suitable permeable Geotextile fabric immediately after removal of existing concrete.
- d) Prior to laying of basecourse the underlying roots shall be protected by laying a suitable permeable Geotextile fabric over the soil surface.
- e) There shall be no positioning (sitting or driving through) of heavy machinery unless this is on an existing hard surface (concrete or paved) or temporary hard surface - see (f) below.

- f) The temporary hard surface methodology must be approved in writing by a qualified arborist or the council's engineer. It shall be constructed by laying geotech matting on the surface, 100mm weed free mulch or similar soft material on a hard surface placed on the soft material, i.e. sheets of plyboard.

All roots that are severed shall be pruned cleanly back to the surface of the excavation using a sharp handsaw or secateurs. All exposed or severed roots shall be kept damp (using hessian cloth or similar) until the excavated area is backfilled.

No damage shall be done to the trunk and above ground parts of any tree that is to be retained.

Any pruning required to facilitate the works to retained trees shall be undertaken by the Arborist.

7.3.2 Reserves Specimen Tree Location

All reserve plantings shall be marked out on site, and approved by Council, prior to planting works commencing.

7.3.3 Site Preparation

All irrigation and drainage works, utilities installation, signs or landscape structures shall be completely installed prior to planting.

Excavation and Bedding of Planting Areas

Excavation shall be carried out where necessary to achieve either of the following required soil profiles where depths indicated are post consolidation.

7.3.3.1 Landscape Planting

Refer to [Drawing D7.1](#).

7.3.3.2 Annual Bedding Planting

Refer to [Drawing D7.1](#).

All waste material shall be removed from site.

The exposed subgrade shall be trimmed and levelled so that no part of the subgrade shall be above the required depth of cut.

7.3.4 Soil

Topsoil, both imported and existing on site, shall be:

- a loam soil of good quality
- free draining
- free of weeds and contaminants
- free of building materials and debris
- screened
- healthy; and

- contain no pans

All new planting areas on existing topsoil shall be deep ripped to a minimum of 300mm prior to planting.

7.3.5 Tree Pits

Saw-cutting of existing seal where required shall be undertaken between 250mm to 300mm from the back of the kerb. The design and measurements must be approved by Council prior to works commencing. The cut line shall be parallel the kerb lines wherever possible. All cut-outs are to be square and to be a minimum 1.0m x 1.0m dimension.

Refer to Drawings [D7.5](#) and [D7.6](#) for tree pit details.

Planting holes shall be excavated, according to the following specification:

Table 7-7: Tree Pits Design Criteria

TREE TYPE	TREE GRADE	PIT SHAPE	PIT DEPTH
Street Trees	45 litre	1.0m x 1.0m square	1000mm
Park/Reserve Tree	45 litre	2.0m diameter	1000mm
Park/Reserve Tree	90 litre	2.5m diameter	1000mm

The base of the planting hole shall be forked to a minimum depth of 200mm and any stones over 50mm diameter or poor quality subsoil shall be removed from the hole.

The sides of the planting hole shall also be loosened by forking to 150mm minimum, and the surrounding ground to two times the root ball diameter shall be 'forked' over to reduce compaction.

Where topsoil is unsuitable for backfilling, imported or modified top soil for backfilling shall be used. The imported topsoil shall be a free draining loam of a quality and subject to inspection by Council prior to placement.

Modified backfill soil shall consist of a homogenous mixture of the following.

- Parts by volume of good quality, friable topsoil from the site or imported
- Three parts by volume of council approved compost
- Two parts by volume of coarse river sand

7.3.6 Grassing, Sowing and Turfing

This section covers the preparation and sowing of any new grassed areas or those requiring reinstatement, or turfing of such areas. It includes berms, lawns and embankments.

7.3.6.1 Preparation for Sowing or Turfing

The following conditions apply:

- Grassing and fertilizing shall be carried out over all existing grassed areas disturbed by contract activity and other specified areas which may require reinstatement.

- Excessive compaction of subsoil in existing grassed areas shall be relieved to achieve satisfactory long term growing conditions
- All topsoil removed to permit contract works to be carried out shall be stockpiled for reuse.
- All new grass areas shall be built on soil prepared to industry best practice standards.
- Sloped areas shall be neatly contoured into adjoining grassed areas
- Perennial weeds shall be controlled with industry best practice methods.

7.3.6.2 **Grass Sowing**

The following requirements apply:

- The seed mixture shall be an industry standard quality.
- On large areas the seed shall be “check” sown in at least two directions and surface rolled with suitable flat roller.
- On small areas the grass seed shall be evenly applied and raked into the soil.

7.3.6.3 **Establishment of Sown Areas**

The following requirements apply:

- Newly established grass shall be protected from damage by pedestrian and vehicular traffic until grass has reached a self-sustaining state
- Grassed areas shall be watered as required to achieve an efficient germination of the seed.
- Newly grassed areas shall be maintained with regular mowing (90mm-30mm) ensuring that all clippings are removed from adjacent hard surfaces.

All grassed areas adjacent hardscape - such as paths, kerbs, hardstand areas – to ensure base of grass is flush with adjacent path. If base of grass level is 30mm lower or more than adjacent hardstand, grass will need to be removed min 1m back from path, soil put back in, levelled and re-consolidated to spec and grass re-sown to correct level. If less than 30mm top dressing at 10mm each time, over time will be acceptable until the correct level is achieved.

Turf/Instant Turf

The following requirements apply:

- The turf shall be of good quality in line with industry standards
- Turf shall be installed and maintained in accordance with supplier’s requirements
- Areas of turf where there has been a poor establishment shall be re-laid.

Slope Areas

In all sites, except natural gully systems, where the slope gradient is steeper than 1:3 (one metre high by three metres long), it is preferable that the embankment is either scarified or grooved on an angle to a depth of 200mm, from the top of the bank to the base. This assists topsoil adhesion and prevents separation of the top 150mm topsoil from the base material due to gravity and/or glazed/planning of base material.

7.3.7 Street Tree Planting

7.3.7.1 Timing

All tree planting shall be undertaken between May and August.

All trees shall be planted on the day of delivery to the site.

Council shall be provided with not less than five days' notice of dates upon which planting will commence.

7.3.7.2 Layout

Trees shall be planted in the locations shown on the planting plans and in accordance with these specifications. Unless otherwise indicated on the planting plans all plants shall be planted centrally within the road berm. Refer to Transportation Drawing [D3.1.3](#)

7.3.7.3 Tree Root Barriers

Root barriers shall be installed prior to tree planting. The location of root barriers shall be as specified and centred around the plant stem (refer to [Drawing D7.4](#)).

7.3.7.4 Street Tree Mulching

All street trees must have a minimum 1.0m diameter mulching circle from the tree trunk.

Mulch shall be well rotted organic tree mulch. Mulch shall be free of foreign debris such as rocks and plastic.

Mulch shall be applied to a depth of no more than 150mm after planting. The final settled depth shall be no more than 120mm and no less than 100mm. Ensure that mulch is welled up to ground level around the tree trunk.

7.3.8 Irrigation and Fertilising

7.3.8.1 Irrigation

During installation and establishment, the soil in all planting areas moisture shall be retained to ensure active plant growth throughout the growing season (September – May). To achieve a high level of site presentation or in areas of annual bedding display planting, irrigation systems may be required to achieve this.

Where an irrigation system is required to be installed, 'Toro' brand or a similar approved brand shall be used. The system shall be capable of providing a minimum soil moisture level of 50% to 200mm depth, throughout the planted areas or within the dripline of trees specified. It shall be capable of fully re-wetting the root zone to 200mm depth when the irrigation is applied; and shall be fully automated to operate between 1:00am and 6:00am when moisture levels drop below 50%.

7.3.8.2 Passive Street Tree Irrigation

When surrounded by hard surfaces or as specified, a street tree shall have a 1900mm long section of perforated Novaflow, or similar, perforated pipe inserted into the tree pit. The Novaflow is to run down one side of the tree pit, under the intended root ball and up the opposite side of the tree pit to be level with the ground surface. The other end is

to extend above the intended mulch layer by 20mm. Both ends of the pipe should be capped. Underground irrigation systems can be used instead of manually watering.

7.3.8.3 Fertilising

Generally, some form of fertiliser shall be applied to planting depending on the soil type. For shrubs and trees, all fertiliser shall be well mixed with the backfilled soil. For bedding or groundcover all fertiliser shall be well mixed with the site topsoil prior to planting. Fertilisers shall be either an approved pelletised natural or organic fertiliser or an approved synthetic fertiliser.

An exception to these approved pelletised natural and organic fertilisers or approved synthetic fertilisers is for the Proteaceous species and ferns which should on no account be fertilised with Phosphate (P) containing fertilisers.

Street Trees

All specimen tree plantings shall have two year slow release fertiliser tablets installed at the time of planting.

Grass Sowing and Turf

All fertilisers shall be delivered to the site immediately before they are required for spreading and shall be thoroughly mixed on the site. Council may prohibit the use of any fertilisers which have deteriorated because of interaction, wetting, etc. Fertilisers shall be lightly harrowed into the topsoil, 2-3 days prior to seed sowing, at the following rates at 200kg/ha.

Equation 7-1: Grass sowing rates

<i>30% Potassic Superphosphate</i>	<i>150 kg/ha (15g/m²)</i>
<i>Sulphate of Ammonia</i>	<i>50 kg/ha (5g/m²)</i>

This shall be followed one month after sowing, with an application of:

Di-ammonium Phosphate (DAP) 100 kg/ha.

7.3.9 Quality Control

7.3.9.1 Plant Grades, Species and Quality

General Plant Grades

All plants shall be supplied true to the species and grades specified on the approved landscape plans, and fill the specified planter bag. All street trees, unless specified otherwise, shall be of a minimum grade of 45 litres with a minimum 30mm calliper.

All other stock shall be of minimum 2 litre grade for groundcover and 3 litre grade for shrubs.

General Plant Species and Quality

- a) Where relevant, trees shall be selected from Council's approved tree species list. Where such a list exists, no substitution of species or grade shall be made without the written approval of Council. Where no such list exists, refer to HCC's [Street Tree Species list](#)

- b) All plant material supplied shall be clearly labelled
- c) Council shall be provided with not less than five working days' notice of dates upon which plants are to be delivered on site, so that arrangements can be made for quality inspection and confirmation of identification of plant material
- d) Trees shall be well branched, symmetrical and of typical habit for the species
- e) All plants shall be nursery stock of good form, healthy and vigorous with strong fibrous root systems and free of all pests and diseases
- f) All trees shall be supplied with the central leader intact - no pruning of the central leader shall have taken place. All torn or damaged roots shall be pruned before dispatch. All stock shall be well rooted but not root bound. Open ground stock shall be well-wrenched
- g) All root balls and containers shall be free of all weeds. Plants shall be well 'hardened -off' prior to supply
- h) All plants and their roots shall be maintained in a moist environment, protected from adverse conditions such as drying winds, frost or water logging. All roots must be covered during transit and storage to prevent desiccation or damage.

7.3.9.2 **Street Tree Grades, Species and Form**

All street trees, unless specified otherwise, shall be of a minimum grade of PB 95 and be first grade nursery specimens. No substitution of species or grade shall be made without the written approval of Council.

Trees shall be well branched, symmetrical and of typical habit for the species. All plants shall be nursery stock of good form, healthy and vigorous with strong fibrous root systems and free of all pests and diseases.

All trees shall be supplied with the central leader intact, whereby no pruning of the central leader shall have taken place. All torn or damaged roots shall be pruned before dispatch.

All stock shall be well rooted but not root bound. All root balls and containers shall be free of all weeds.

7.3.10 **Weed and Litter Control**

7.3.10.1 **Litter Control**

The planting area shall be kept clear of all rubbish, including domestic and building materials.

7.3.10.2 **Chemical Applications for Weed and Pest Control**

All chemical application on planted areas shall be carried out by qualified, trained personnel and according to NZS 8409:2004 – Management of Agrichemicals, any relevant local Herbicide Policy and manufacturers' requirements.

All spraying operations shall be carried out in windless, dry conditions, when rain is not imminent for at least 12 hours and at times which minimise possible hazards or disruption to the public, animals or other beneficial fauna. Care shall be taken to prevent spray drifting onto non-target areas or plants and comply with notification requirements as required by the proposed Waikato Regional Plan.

Herbicides may be used to control weeds or excess grass growth over structures, surfaces or into planting areas. Refer to Section 8 for approved herbicides.

All trees in grassed areas shall have a weed release spot spray applied between four and six months after planting. General weed control shall be carried out whenever necessary to maintain the planting weed-free.

Chemical weed control in planting areas shall be kept within the edge of the planting beds, within a maximum of 500mm of tree trunks, within 50mm of the edge of any undefined mulch surface, and within 50mm of any posts or the base of any landscape structures.

7.3.11 Mulching

Unless otherwise approved by Council, all new planting areas shall be mulched. All care shall be taken in placing the mulch so as to protect the plants and any irrigation system, ensuring that no plant canopy is covered by mulch post-installation. All damage to the plants or irrigation system shall be rectified.

7.3.11.1 Site Specific Mulch Applications

Flat Site Mulch

On sites flatter than a 1:2 grade (1.0m high by 3.0m metres long), bark or arb mulch shall be spread evenly to a depth of 80-100mm over the planted area, creating an inverted cone hollow around each plant stem with a maximum 25mm depth around plant stems. The mulch shall be supplied as scheduled, clean and free of soil, sawdust and wood preservatives, and a sample shall be provided to Council for approval prior to spread.

- a) Coarse untreated shredded pine bark should have an average diameter of 50mm and with no pieces longer than 100mm. Coarse bark is appropriate to most locations
- b) Fine untreated shredded pine bark should have no pieces longer than 40mm and be evenly graded. Fine bark may be specified by Council in commercial areas, or for other specified locations
- c) Aged woodchip or arb mulch may be used at the Council's discretion

Steep Site Mulch

On slopes steeper than 1:2 mulching for weed control shall consist of a Council approved matting with the following criteria:

- a) The matting consists of:
 - (i) A single layer of biodegradable mulching fabric or material without synthetic geonet or synthetic geotextile content; with
 - (ii) At least 1000gsm density composed of approximately 100-125mm long coir fibres; and
- b) Has preferably a 100 percent rubber-based binder to hold the fibres together
- c) It shall be installed according to manufacturer's instructions prior to planting, ensuring that the matting will not uplift due to inundation or interference from wildlife.

- d) The mulching fabric shall have a minimum 24 month life expectancy and be fully biodegraded into the soil within six years. It should be able to be walked on by maintenance staff, without causing damage to the fabric, for the first 12 months after installation.
- e) Pegs used with matting also need to be biodegradable.

A simple test to ascertain whether the mulching fabric is viable is to hold a sample to the sky. It should be mostly opaque. This density inhibits weed seeds trapped under the mulching fabric from sprouting, provides good moisture retention and assists with batter erosion control.

At Council's discretion, mat rounds may be used instead of matting. These shall be a minimum 500mm diameter and have the same characteristics as the mulch fabric. Each round shall have 8 pins: 4 pins equidistant near the outer edge and 4 pins around the plant stem.

On steep slopes (1 in 4) with erosion issues that are receiving planting, biodegradable netting with no geotextile or geonet content shall be used at Council's discretion. The netting will have an expected lifespan of at least 36 months. This may be placed on top of the mulch matting and shall be installed according to manufacturer's instructions. The netting is not intended to suppress weeds and should be used in conjunction with mulch matting or rounds.

7.3.12 Staking, Fencing and Protection

7.3.12.1 Specimen and Street Trees

Newly planted specimen trees shall be staked with two 50 x 50 x 1.8m rough sawn Pine H4 treated or hardwood stakes with at least one third of their length (600mm) in the ground and at least 1.0m exposed minimum, or as specified on the plan with the approval of Council. Two flexible biodegradable ties per stake shall be attached. Ties shall be tensioned to avoid chafing of the tree against the stakes but with enough play for the tree to move in the wind. All ties shall be fixed to the stakes.

Ties shall be positioned no more than one third of the height of the tree on the stake.

All staking shall be parallel with the road kerb for street trees, north and south for specimen trees

All stakes shall be inserted to avoid hitting the root ball.

Non-Street Tree Staking

Unless otherwise approved by Council:

- a) All shrub species shall be planted at 1.3 litre to 5 litre grades
- b) All tree species shall be planted at greater than 2.5 litre grades
- c) All non-street trees shall be staked with a rough sawn pine H4 stake with a biodegradable tie or a Council-approved alternative.

The tie shall be removed at a time designated during the design phase of the landscape planting.

Some nursery-supplied plants are provided with a stake attached, usually directly against the main stem. This stake is to be removed and replaced according to this specification.

7.3.12.2 Livestock Fencing

Where required livestock fencing shall be provided. At road frontages, no hot wires shall be used unless they are attached at 300mm inside a physical barrier.

The stock-proof fence shall be a durable fence which achieves the required purpose of preventing access of all livestock to the site under development. At road frontages the fence shall meet the following minimum standards:

Table 7-8: Livestock Fencing Standards

COMPONENT	TYPE	SIZE AND PLACING
Strainers	No.1	2.4m long with stay
Angles	No.1	2.1m long with stays (if required) at fence line
Stays	No.2	2.4m long
Posts	No.2	1.8m long
Battens	50 x 40	Equidistant placing, 0.8m maximum spacing
Wire	High Tensile Wire	8 wires

The wires shall be facing the roadside with posts and battens behind.

Strainers shall be set to lean away from the angle of the fence to some extent or at worst be vertical upon completion of the tensioned fence.

In poor soil conditions or variable topography, longer posts, longer strainers and more substantial footings and stays shall be used where necessary to achieve a stable fence.

7.3.13 Pruning

Pruning should be carried out in accordance with acceptable aboricultural and horticultural practices with oversight from Council’s arborist.

7.4 DEFECTS LIABILITY

Works to be carried out under the defects liability period include routine maintenance of the landscape planting works i.e. weeding, litter removal, mulching, watering and replacement of dead or diseased plants. Refer [Form F7.1](#).

Council may periodically check the site to ensure that maintenance requirements are being met. Should any defects be identified, the defects shall be remedied or mitigated within one month.

7.4.1 As-built Information

Upon completion of construction work, copies of As-built plans and data attributes of the completed works, as described in Clause 1.9 of Section 1 : General, shall be provided to the Council. Separate plans are required for wastewater, stormwater, and water supply.

Responsibility for providing the plans and associated data shall lie with:

- a) The Developer, in the case of land development (urban and industrial subdivision).
- b) The Contractor, in the case of works constructed for Council under contract to Council.

7.4.2 Works clearance Inspection

After completing all proposed works Council shall be provided notice at least seven working days prior to the proposed commencement of the defects liability period and shall be available for a joint pre-defects liability period inspection.

7.4.3 Defects Liability Period Final Inspection

The Developer/Contractor shall request acceptance from Council of the asset and its ongoing maintenance at least 7 working days prior to the end of the defects liability period. Refer [Form F7.2](#).

The General Planting Defects Requirements apply to all planting, except where Street Trees and Grass Turf have been planted.

7.4.4 Street Trees Defects Liability Period

The planting defects liability period shall be 2 years from works clearance or practical completion (or as defined in the resource consent) and acceptance of the landscape planting works by Council or upon release of any implementation bond held for uncompleted landscaping.

A copy of the as-built plan recording any variation from the approved landscape planting plans shall be provided to Council.

7.4.5 General Planting Defects Liability Period

The planting defects liability period shall be 2 years from works clearance or practical completion (or as defined in the resource consent) upon release of any implementation bond held for uncompleted landscaping.

During and at the end of the defects liability period, the following minimum standards are required:

- a) All topsoiled areas prior to planting and mulching shall be weed-free.
- b) All planted areas shall be kept weed-free.
- c) All planted areas including street trees shall be replenished with bark or arb mulch.
- d) All trees and other planting shall be vigorous and healthy, free of disease and free of dead growth or dead flowers.
- e) If planting is to take place during drier, summer months, provision of temporary on-site irrigation should be discussed with Council.
- f) The planting has become established. Any plants failing during this period shall be replaced to the specification, to ensure adequate establishment of the planting.
- g) The plant growth shall have been trimmed to the extent and height required for any visibility splays.

- h)** All tree stakes and ties shall be intact and correctly installed.

Refer to Table 7-9 for further maintenance objectives, methodology and frequency requirements.

7.4.5.1 Replacement Planting

All replacement plants shall have been successfully established for at least three months prior to the final defects check. Council reserves the right to request replacement records that preferably include dated digital photographic evidence to verify installation dates.

7.4.6 Fencing and Landscape Structure Defects Liability Maintenance

During and at the end of the defects liability period the following minimum standards shall be maintained

- a) All permanent or temporary landscape structures shall be structurally sound, safe, functional or operational and in a presentable finished form
- b) Paint work and other finishes shall be maintained in a clean and presentable finished form. Bolts and other fixtures shall be maintained sound and without loose parts or rough edges
- c) All structures shall be free of litter, graffiti, grime, weeds and plant growth or any other foreign matter
- d) Borders, footing edges or paving shall be maintained so that no more than 25mm of grass or other vegetation is allowed to encroach. Vertical elements without mowing edges shall have vegetation maintained clear of the structure by no less than 25mm and no more than 75mm

7.4.7 Grassing and Turf Defects Liability Period

After initial establishment, during and at the end of the defects liability period, the following minimum standards shall be maintained:

- a) All kerb and channelled verges shall have grass growth no more than 50mm high, non-kerb-and-channelled verges shall have grass growth no more than 200mm high and banks shall have grass growth not more than 250mm high.
- b) The sward shall be maintained in a healthy, weed-and-disease free state without bare patches.
- c) Trees and other plantings shall be protected from damage by maintenance or mowing operations and if damaged shall be reinstated within one week of the damage occurring.
- d) Maintenance and mowing operations shall be carried out at times which minimise disruption to the public.
- e) Maintenance and mowing operations shall be carried out only in conditions with equipment that ensures maintenance of good soil structure, minimum deformation of ground surfaces and on-going establishment of the grass sward.
- f) Litter shall be removed prior to commencing maintenance or mowing operations. Highly visible shredded litter shall be removed following maintenance and mowing.
- g) Grass clippings, when not required to be collected during mowing, shall be spread evenly over the sward.

Table 7-9 : Minimum General Landscape Maintenance Schedule during Defects Liability Period

DEFECTS LIABILITY PERIOD MAINTENANCE	REGIME	FREQUENCY	TERM	SEASON
Compliance Inspections – Council	Assess that site(s) is being maintained as per specification	Three months maximum; or as required	Defects duration	All
Compliance Inspections – Developer / Contractor	Check for problem weeds, failed plants, pest damage, pruning and replacement needs Ensure mulch application correct depth / coverage / placement	Monthly	Defects duration	All
Fertiliser (in planting areas)	Pellets: NPK at 100g/m ² on shrub planted areas or 100g/tree	Pellets: Once only at start of second growing season or after replacement planting	As applicable	Spring preferably
	Foliar Feed: On Council approval, apply approved liquid foliar feed	Foliar feed: Once two weeks prior to end of defects and liability period		
Mulching	Bark and arb mulch: Maintained at 80-100mm depth with 25mm depth around stem with inverted hollow cone. Mulch travel not evident outside planting area	Bark and arb mulch: Replace / top up once after planting (if required)	Bark and arb mulch: No more than two months before end of Defects	Apr-Oct preferably
	Matting Rounds: Check and ensure pins and matting installed correctly, fabric is intact	Matting and Rounds: Replace / repair fabric and pins (as required)	Matting and Rounds: Periodically throughout Defects	
Plant Replacement	Replace according to allocated planting scheme Plant Schedule species and centre(s)	As determined by Compliance Inspections	Up to three months before end of defects and liability period	Winter-Spring
Rubbish	Remove to waste domestic and builders rubbish from planted areas	Monthly	Defects duration	All
Staking	Damaged ties and stakes (including those leaning over) are to be replaced and reinstalled, including stakes on lean. Replant plant if on lean ensuring roots not exposed	As required. Two month inspection rotation	Defects duration	All
Weed Control	Manual removal of weeds or 'knock-down' herbicide. No spraying near waterways	Monthly	Defects duration	All

APPENDIX 7A: DRAWINGS

Table 7-10: Drawing Register

DRAWING NO	TITLE
D7.1	Landscape Planting Areas
D7.2	Street Tree Planting Clearances
D7.3	Tree Pits Within Carriageway
D7.4	Street Tree Root Barrier
D7.5	Tree Pits within Carriageway Pavements
D7.6	Kerbside Tree Pit
D7.7	Timber bollard post and chain

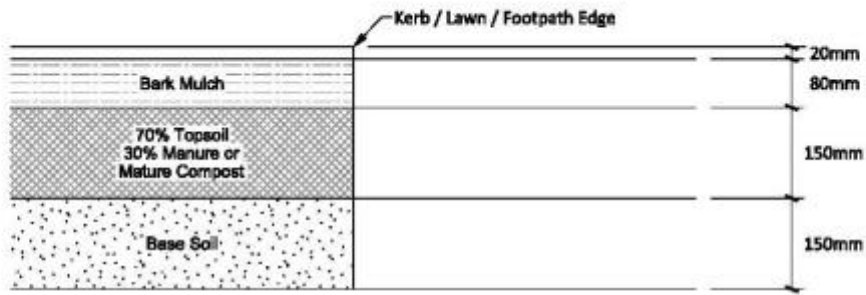

FIGURE 1: PLANTING AREA
 Topsoil and Mulch Profile, post-consolidation, for slopes less than 1:3.

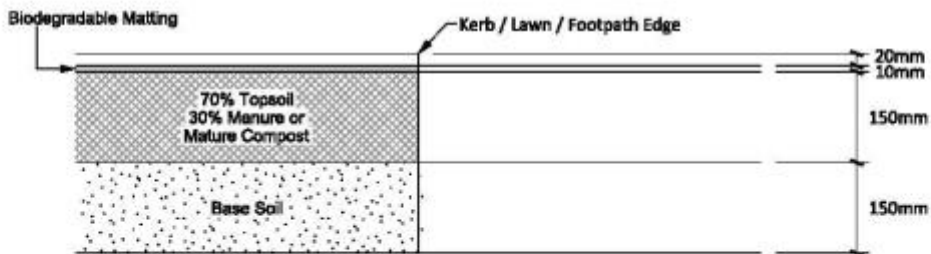

FIGURE 2: PLANTING AREA
 Topsoil and Mulch Profile, post-consolidation, for slopes greater than 1:3.

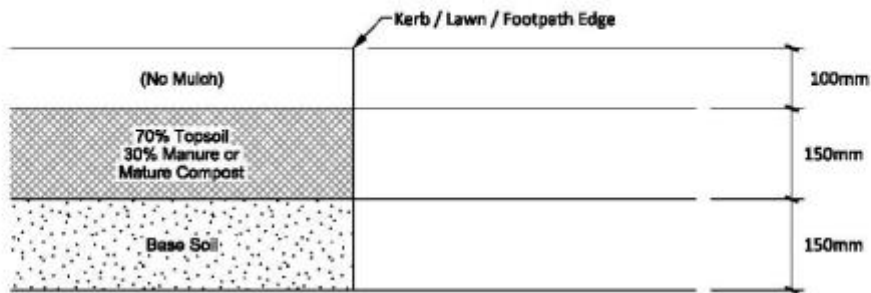
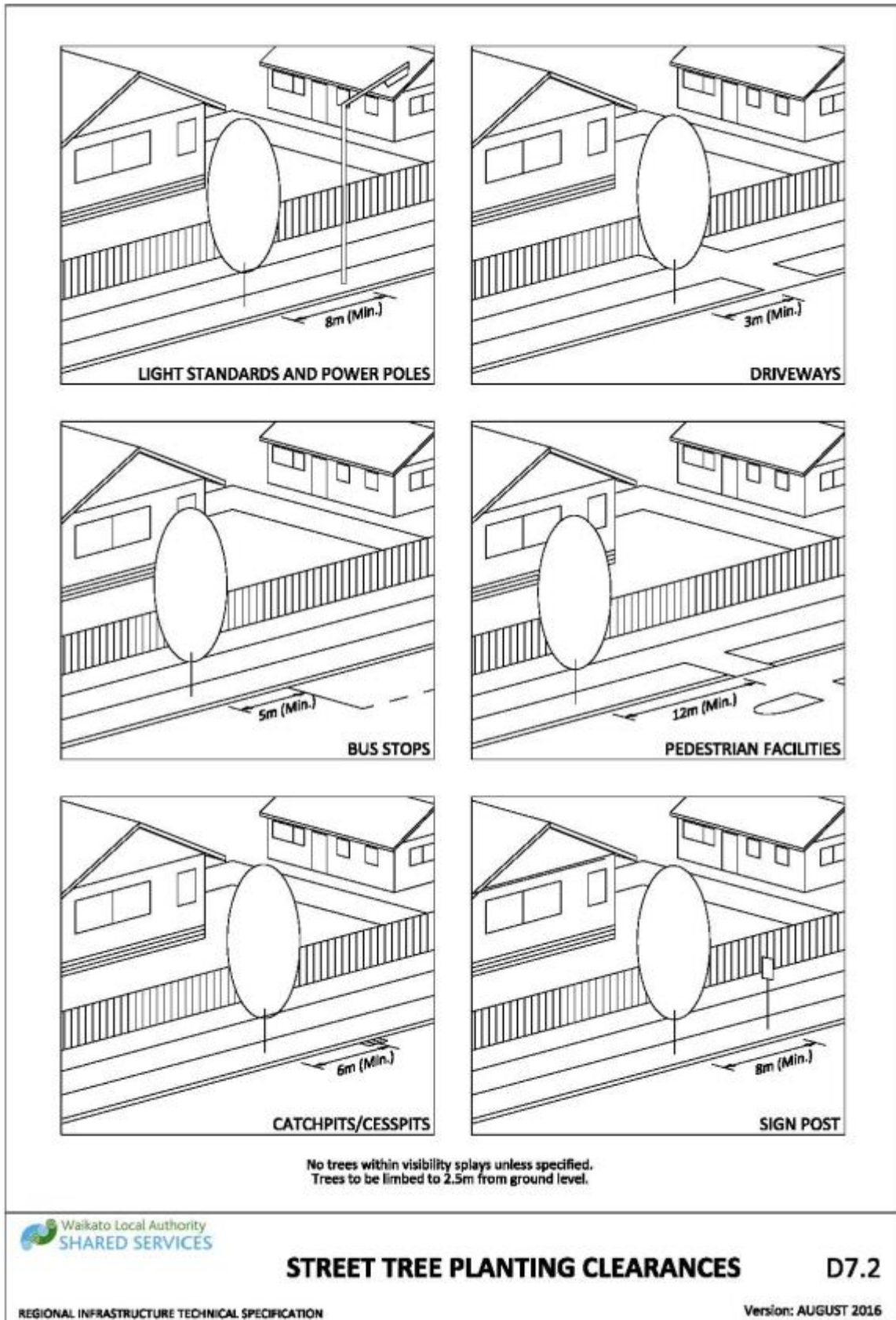
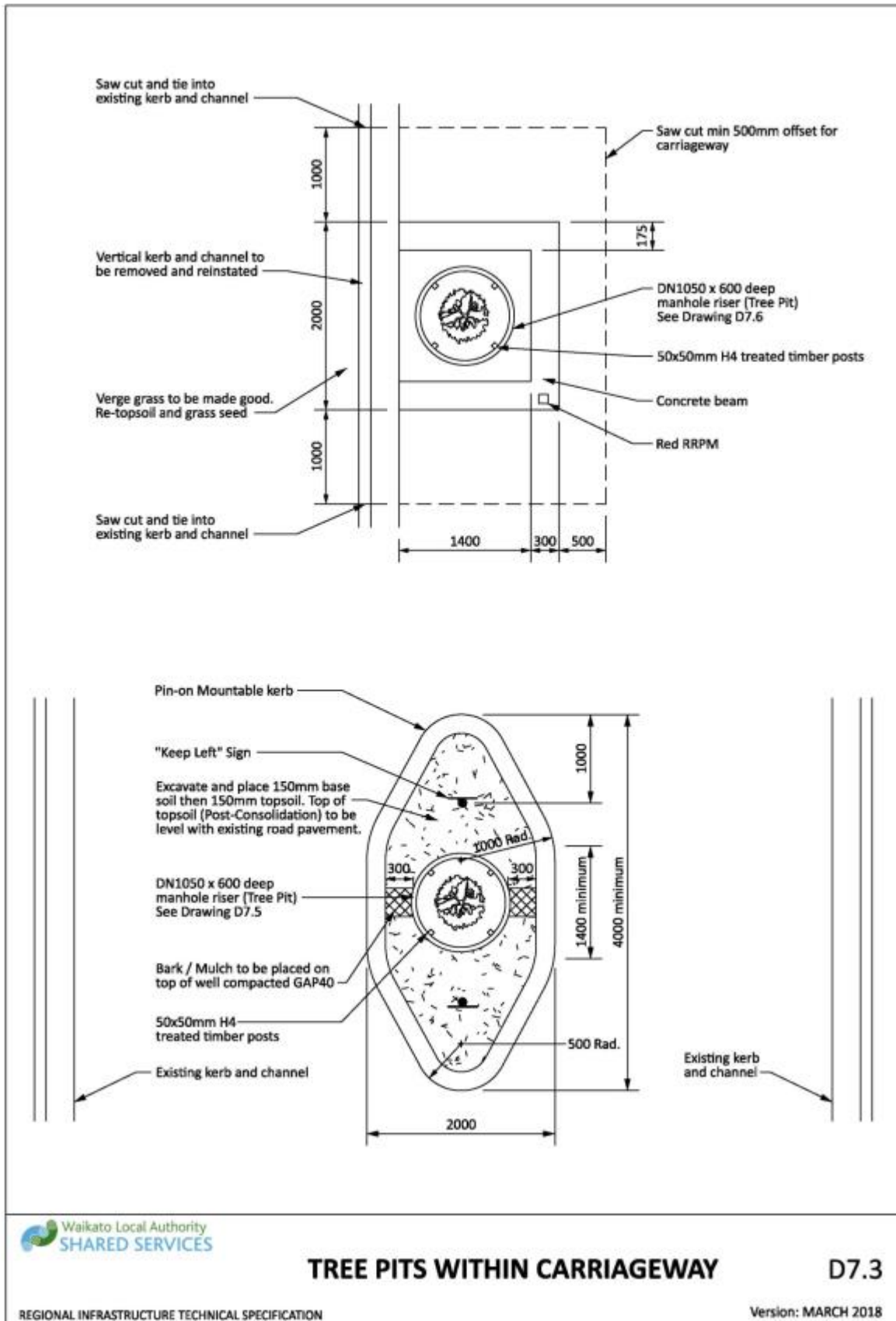

FIGURE 3: ANNUAL PLANTING AREA
 Topsoil Profile, post-consolidation.

Drawing 7-1: Landscape planting areas



Drawing 7-2: Street tree planting clearances



Drawing 7-3: Tree pits within carriageway

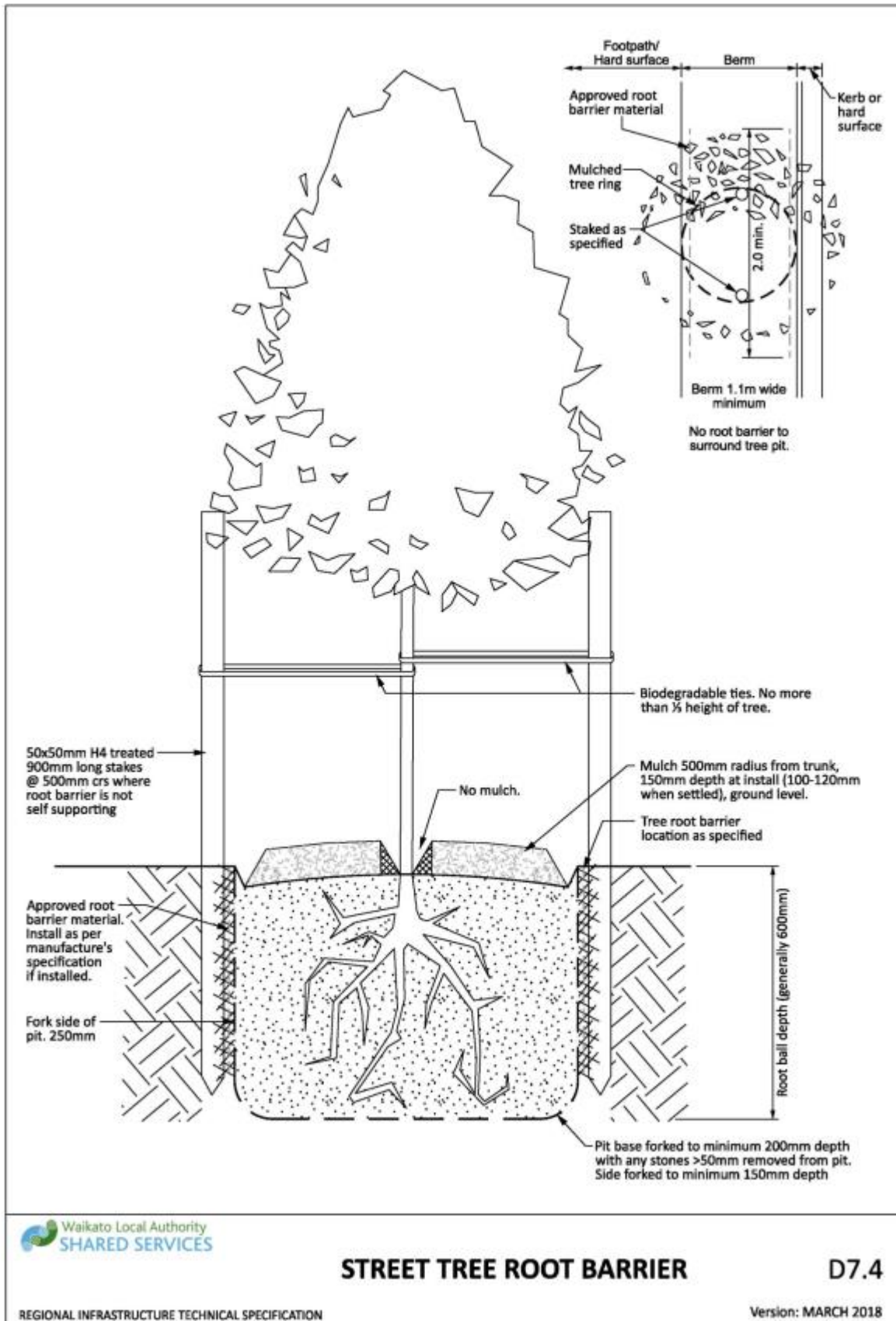

Drawing 7-4: Street tree root barrier

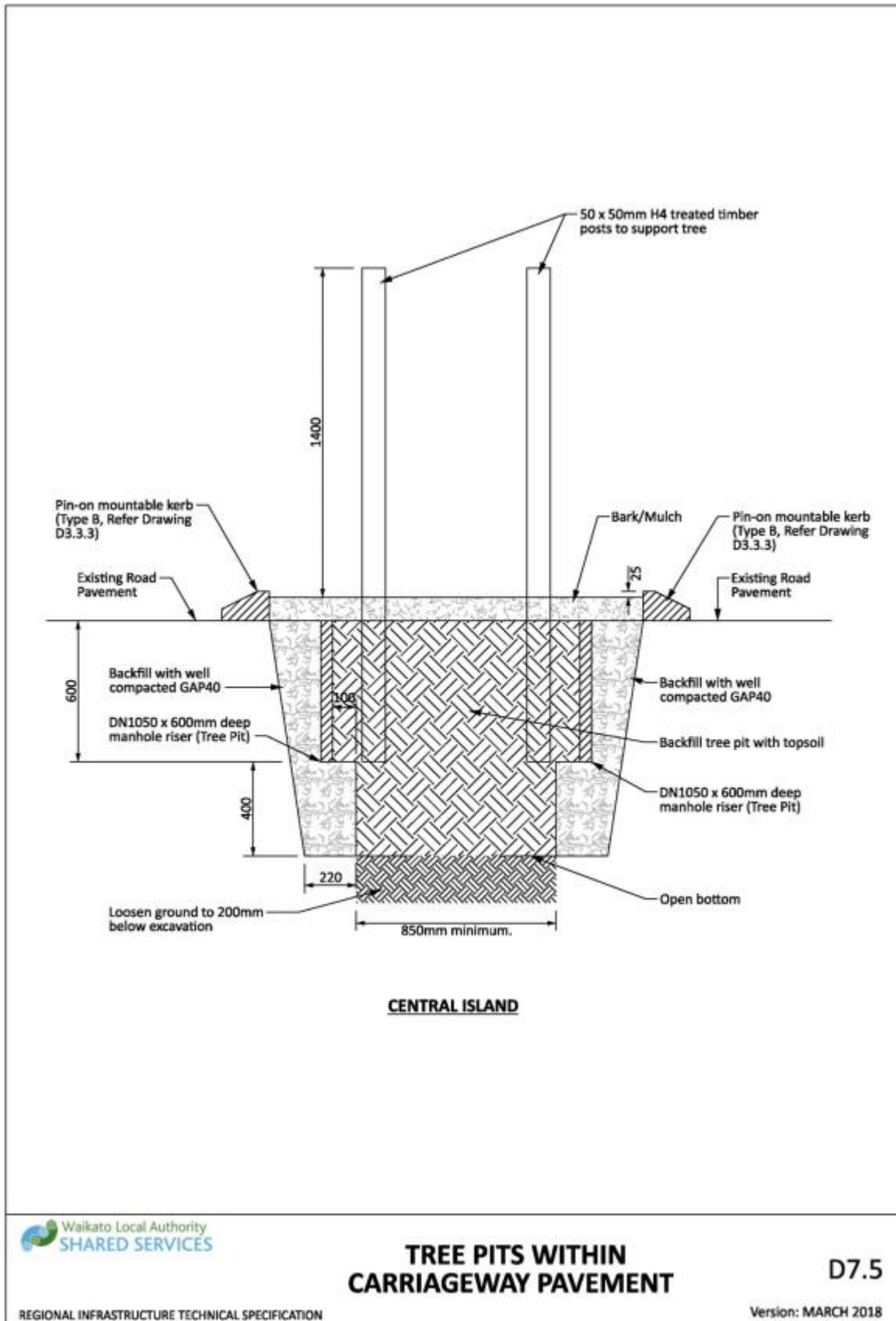

Drawing 7-5: Tree pits within carriageway pavement

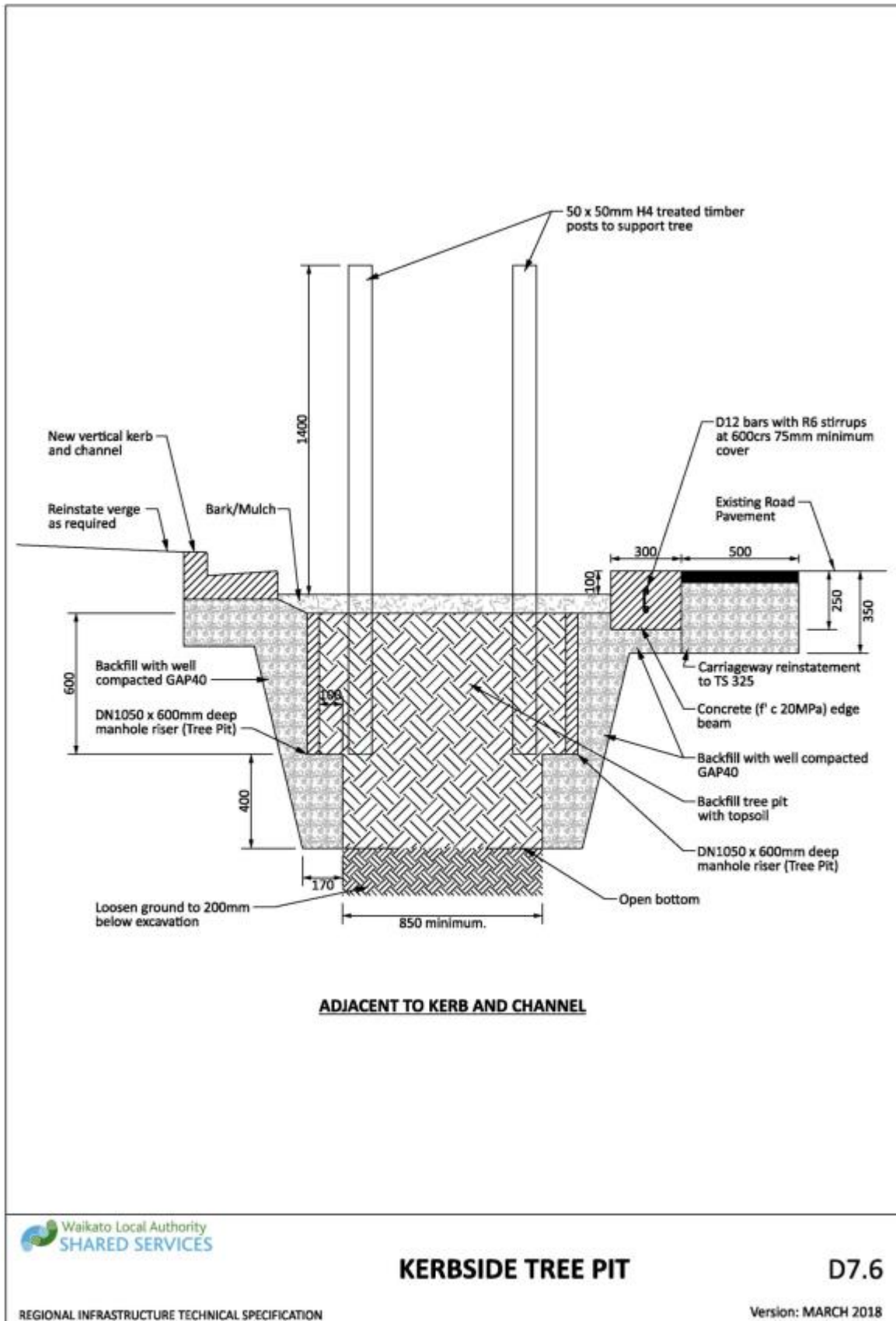

Drawing 7-6: Kerbside tree pit

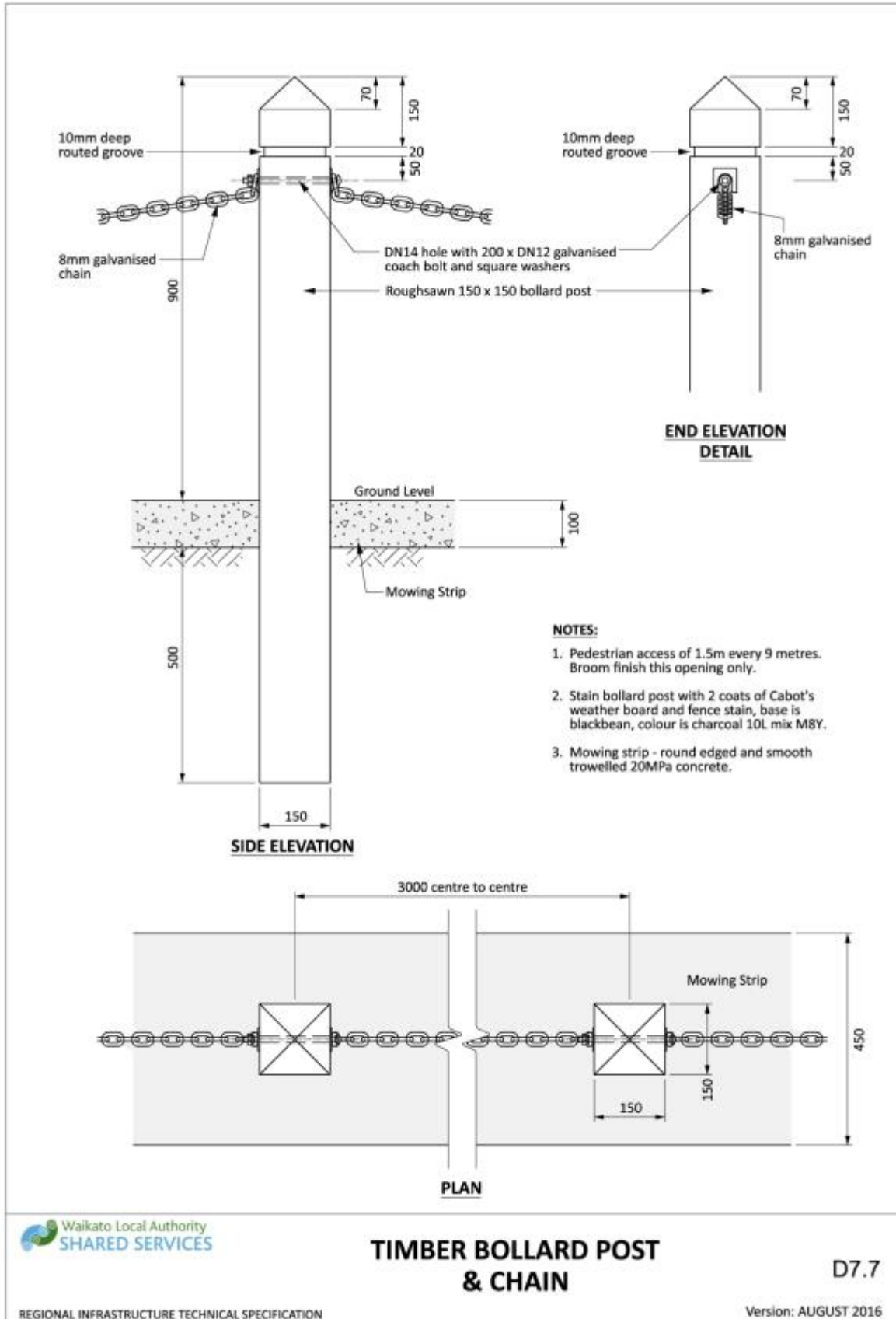

Drawing 7-7: Timber pollard post and chain

APPENDIX 7B: PLANT NUMBER CALCULATOR

Plant Number Calculator

To calculate plants required for level sites, determine the plant centre required:

Equation 7-2: Plant number calculator for level sites

Planting Area X Level Site

Example: Plants to be planted at 300mm centres in a Planting Area of 10m² on a Level Site

Planting Area (10m²) X Level Site (11.11) = 111 plants required

To calculate plants required on sloped sites, determine the plant centre required:

Equation 7-3: Plant number calculator for sloped sites

Formula: (Plant Area X Level Site) X Slope gradient

Example: Plants to be planted at 300mm centres in a Planting Area of 10m² on a Slope 1:1 (1 horizontal to 1 vertical)

(Planting Area (10m²) X Level Site (11.11)) X Slope multiplier (1.41) = 157 plants required

PLANT CENTRES (MM)	MINIMUM AREA APPLICABLE (M ²)	MULTIPLIERS				
		LEVEL SITE	SLOPE 1:1	SLOPE 1:2	SLOPE 1:3	SLOPE 1:4
250	0.10	16.00	1.41	1.12	1.05	1.025
300	0.15	11.11	1.41	1.12	1.05	1.025
400	0.25	6.25	1.41	1.12	1.05	1.025
500	0.25	4.00	1.41	1.12	1.05	1.025
600	0.50	2.75	1.41	1.12	1.05	1.025
700	0.75	2.05	1.41	1.12	1.05	1.025
750	0.75	1.78	1.41	1.12	1.05	1.025
800	1.00	1.56	1.41	1.12	1.05	1.025
900	1.00	1.23	1.41	1.12	1.05	1.025
1000	1.00	1.00	1.41	1.12	1.05	1.025
1100	1.25	0.83	1.41	1.12	1.05	1.025
1200	1.50	0.69	1.41	1.12	1.05	1.025
1300	1.75	0.59	1.41	1.12	1.05	1.025
1400	2.00	0.51	1.41	1.12	1.05	1.025
1500	2.50	0.44	1.41	1.12	1.05	1.025
1600	2.75	0.39	1.41	1.12	1.05	1.025
1700	3.00	0.35	1.41	1.12	1.05	1.025
1800	3.25	0.31	1.41	1.12	1.05	1.025
1900	3.75	0.28	1.41	1.12	1.05	1.025
2000	4.00	0.25	1.41	1.12	1.05	1.025
2100	4.50	0.23	1.41	1.12	1.05	1.025

PLANT CENTRES (MM)	MINIMUM AREA APPLICABLE (M2)	MULTIPLIERS				
		LEVEL SITE	SLOPE 1:1	SLOPE 1:2	SLOPE 1:3	SLOPE 1:4
2200	4.75	0.22	1.41	1.12	1.05	1.025
2300	5.50	0.19	1.41	1.12	1.05	1.025
2400	6.00	0.17	1.41	1.12	1.05	1.025
2500	6.25	0.16	1.41	1.12	1.05	1.025
2600	6.75	0.15	1.41	1.12	1.05	1.025
2700	7.25	0.14	1.41	1.12	1.05	1.025
2800	7.75	0.13	1.41	1.12	1.05	1.025
2900	8.35	0.12	1.41	1.12	1.05	1.025
3000	9.25	0.11	1.41	1.12	1.05	1.025

APPENDIX 7C: FORMS

Table 7-11: Forms and Checklists

NUMBER	TITLE
F7.1	Street Trees and Gardens Pre Defects liability Period Inspection
F7.2	Street Trees and Gardens Final Inspection

F7.1 STREET TREES & GARDENS – PRE-DEFECTS LIABILITY PERIOD INSPECTION

Pre-Meeting Tasks

Organisation	Action Required	Yes	No	N/A
Contractor	1) Complete all work indicated on drawings	<input type="checkbox"/>	<input type="checkbox"/>	<input type="checkbox"/>
	2) Trees staked, tied and mulched	<input type="checkbox"/>	<input type="checkbox"/>	<input type="checkbox"/>
	3) Mow grass	<input type="checkbox"/>	<input type="checkbox"/>	<input type="checkbox"/>
	4) Gardens planted, barked and weed-free	<input type="checkbox"/>	<input type="checkbox"/>	<input type="checkbox"/>
	5) Irrigation installed to specification	<input type="checkbox"/>	<input type="checkbox"/>	<input type="checkbox"/>

SITE MEETING

In Attendance

Council Officer _____
 Council Officer _____
 Contractor _____
 Consultant _____

1) Inspect site	<input type="checkbox"/>	<input type="checkbox"/>	<input type="checkbox"/>
2) Plans and specifications complied with	<input type="checkbox"/>	<input type="checkbox"/>	<input type="checkbox"/>
3) Check mowing	<input type="checkbox"/>	<input type="checkbox"/>	<input type="checkbox"/>
4) Acceptable standard agreed upon	<input type="checkbox"/>	<input type="checkbox"/>	<input type="checkbox"/>

DEFECTS LIABILITY PERIOD

6 months 1 year 2 years (delete as required)
 Start of Defects Liability Period _____ End of Defects Liability Period _____

Items to be Provided/Corrected

No	Action Required	Party to Action	Party to Accept	Acceptance	
				Approved	Date

Council

Developer

Date

F7.2 FINAL INSPECTION – STREET TREES & GARDENS

Pre-Meeting Tasks

Organisation	Action Required	Yes	No	N/A
Contractor	1) Make sure site complies with standards as agreed at pre-maintenance inspection	<input type="checkbox"/>	<input type="checkbox"/>	<input type="checkbox"/>
	2) Trees staked, tied and mulched	<input type="checkbox"/>	<input type="checkbox"/>	<input type="checkbox"/>
	3) Dead and damaged trees replaced	<input type="checkbox"/>	<input type="checkbox"/>	<input type="checkbox"/>
	4) Mow grass	<input type="checkbox"/>	<input type="checkbox"/>	<input type="checkbox"/>
	5) Gardens planted, barked and weed-free	<input type="checkbox"/>	<input type="checkbox"/>	<input type="checkbox"/>
	6) Irrigation In working order	<input type="checkbox"/>	<input type="checkbox"/>	<input type="checkbox"/>

SITE MEETING

In Attendance

Council Officer _____
 Council Officer _____
 Contractor _____
 Consultant _____

1) Inspect site	<input type="checkbox"/>	<input type="checkbox"/>	<input type="checkbox"/>
2) Trees staked, tied and mulched	<input type="checkbox"/>	<input type="checkbox"/>	<input type="checkbox"/>
3) Gardens barked and weed-free	<input type="checkbox"/>	<input type="checkbox"/>	<input type="checkbox"/>
4) Gardens and planting meet agreed standards	<input type="checkbox"/>	<input type="checkbox"/>	<input type="checkbox"/>
5) Dead and damaged plants replaced	<input type="checkbox"/>	<input type="checkbox"/>	<input type="checkbox"/>

HAND-OVER

1) Gardens and street trees now acceptable for hand-over to Council for ongoing maintenance	<input type="checkbox"/>	<input type="checkbox"/>	<input type="checkbox"/>
---	--------------------------	--------------------------	--------------------------

Council to take over maintenance as from: _____

Items to be Provided/Corrected

No	Action Required	Party to Action	Party to Accept	Acceptance	
				Approved	Date

Council

Developer

Date

8 ACCEPTABLE PRODUCTS

8.1	Acceptable Products – General	584
8.1.1	Purpose	584
8.1.2	Scope	584
8.1.3	Removal from Acceptable Products List	584
8.1.4	Acceptable Product Lists	585
8.2	New Product Acceptance Process	586
8.2.1	The Application	586
8.2.2	The Decision Process	586
8.2.3	Product Evaluation Panel.....	587
8.2.4	Trial Installation (where relevant)	587
8.2.5	Declining an Application.....	588
8.2.6	Removal from Acceptable Products List	588
8.3	Acceptable Product Lists	589
8.3.1	C1 : General Products	589
8.3.2	C2 : Water Supply Products.....	591
8.3.3	C3 : Stormwater Products.....	596
8.3.4	C4 : Wastewater Products	597
8.3.5	C5 : Landscaping Products (to be developed)	599
8.3.6	C6 : Transportation Products (to be developed).....	599

LIST OF APPENDICES

No table of figures entries found.

LIST OF TABLES

Table 8-1:	General products	589
Table 8-2:	Water supply products	591
Table 8-3:	Stowmater products	596
Table 8-4:	Wastewater products	597
Table 8-5:	Landscaping products.....	599
Table 8-6:	Transportation products	599

LIST OF FIGURES

No table of figures entries found.

LIST OF DRAWINGS

No table of figures entries found.

LIST OF EQUATIONS

No table of figures entries found.

8.1 ACCEPTABLE PRODUCTS – GENERAL

8.1.1 Purpose

Products used in the construction and maintenance of infrastructure are one of the key elements in the success or failure of the assets to reach the design life. There are many types and versions of products in the market place, and one of the big challenges for asset owners, consultants and contractors is knowing which ones will meet the design life requirements.

Well made products will possibly cost a little more than those of lower quality, but this cost becomes irrelevant if they need to be replaced earlier than planned or expected. The cost of this should not be unfairly transferred to ratepayers.

Developing a list of products that are acceptable to Asset owners, provides certainty and a level playing field for consultants and contractors that ultimately saves ratepayers and shareholders money and increases resilience.

8.1.2 Scope

This specification covers the list of products and fittings acceptable for use within the Councils utilising the Regional ITS. This covers products and fittings council has, or will, assume a continuing responsibility for.

Products not contained in the accompanying list may be rejected with a requirement to remove the non-complying product from the construction site at no cost to Council.

For specific design requirements, such as reservoir construction, interceptor sewers and structures, where a designer identifies a solution/product that is not currently accepted, the approval process outlined in [Section 1, Clause 1.1.42 : Alternative Design](#) applies.

8.1.3 Removal from Acceptable Products List

Waikato LASS reserves the right to delete any product or material from the Acceptable Products List as and when required. Removing a product may occur for many reasons but will most likely be for one of the following;

- a) Experience shows that the product or material does not meet the application criterion as expected.
- c) The source has changed
- d) The product is no longer available cost effectively in New Zealand
- e) The product has been discontinued
- f) Improved replacement product/material has become readily available

Waikato LASS will consult with the affected manufacturer outlining the reasons for the proposed removal of the material or product or material. The manufacturer will be given reasonable time to respond.

Deleted products will be removed from the Acceptable Products List as and when required.

8.1.4 Acceptable Product Lists

The following are the column headings within the Accepted Products Lists (see [Part C](#) of this section):

Category	The type of product
Application	What the product is used for
Sizing	The size (in mm) of the product
Product	The brand name and manufacturer's unique ID number of the product or material
Standards	The applicable standards and class requirement for the product or material
Manufacturer	The company who made the product.
Licence Mark	The company's product licence mark
Expiry Date	Expiry date of the Licence
Comments	Any notable requirements for the product.

8.2 NEW PRODUCT ACCEPTANCE PROCESS

8.2.1 The Application

All applications for acceptance of a product to be included on a list must be made on the prescribed "[Application Form](#)".

The following supporting information is required, as a minimum:

- a) Evidence that the product conforms to the appropriate New Zealand, Australian, British, ISO Standard or OIMLP*;
- b) Evidence of the licence mark number issued where appropriate;
- c) Details of composition, dimensions, specific use and design life supplied by the manufacturer;
- d) Details of acceptance by other New Zealand local authorities where appropriate;
- e) Installation, operational and maintenance details.

*Where there is no standard, the manufacturer must supply copies of their quality assurance procedures and producer statements to support the composition and performance claims for the product.

Completed applications and supporting information should be addressed to the Waikato LASS secretary at Waikato District Council, Private Bag 544, Ngaruawahia 3742 (07 824 8633), and/or emailed to RegionallTS@waidc.govt.nz.

It is intended that the Acceptable Products list will be updated twice per year in March and September.

To be considered for inclusion on the Acceptable Products list fully completed applications must be received by the Secretary 6 weeks prior to any update.

8.2.2 The Decision Process

Each application will be considered against the following criteria:

- a) The application form and supporting information
- b) Durability of the product during transport, storage and installation
- c) Any sample provided
- d) The track record of the manufacturer making the application
- e) Any specific installation requirements
- f) Reliability
- g) Parts availability
- h) Parts life expectancy in the physical environment it will be subjected to
- i) Maintenance requirements
- j) Manufacturer support
- k) Frequency and ease of replacement: and
- l) Compatibility with the existing network.

The products will initially be evaluated by the Regional ITS Project Manager (the RITS Manager) who will liaise directly with the product applicant.

Products not on the list can be considered for immediate use, but will need to be accepted in writing prior to installation, and meet the above criteria.

It cannot be assumed that by meeting all technical specifications of approval that a product or material will be accepted. Asset Management considerations e.g. operating, maintenance and replacement costs, product/material compatibility within networks and systems are as important as any other criteria Council considers.

Where the RITS Project Manager considers a proposed product may be suitable for acceptance, the following process will be followed:

- a) The RITS Project Manager will acknowledge receipt of the application with the applicant and add it to the list of products to be considered at the next 6-monthly review.
- b) The RITS Project Manager will forward a copy of the application and supporting information to the Product Evaluation Panel (see following clause) and relevant Council Asset Managers for their information and preliminary feedback, e.g. whether the product could/should be trialled.
- c) The RITS Project Manager will consider any feedback received and determine if a product trial is appropriate.
- d) Where appropriate, the RITS Project Manager will arrange for a product trial to be initiated.
- e) The Product Evaluation Panel carries out their scheduled 6-monthly review and makes a decision to accept, trial or decline the product(s).
- f) Where the product is accepted, the RITS Project Manager will update the Acceptable Products list and notify the applicant accordingly.

8.2.3 Product Evaluation Panel

The Production Evaluation Panel is an informal panel of experienced professionals that comprises the following:

- The Regional Infrastructure Technical Specification Project Manager (the RITS Project Manager), who will chair panel meetings.
- Relevant Council Asset Managers (appropriate to the asset/s related to the product being applied for).
- (optional) An independent industry expert (not connected in any way to the product, manufacturer, supplier or Council).
- (optional) Any other professional the Evaluation Panel considers would assist in reviewing the application. (This professional may be a member of Council staff or be an external party.)

The Product Evaluation Panel will convene bi-annually in January/February and July/August, or when a decision of extreme challenge or difficulty is required. This ensures a more streamlined and less expensive management process for the Council and applicants.

8.2.4 Trial Installation (where relevant)

Where trial installation is recommended by the Project Evaluation Panel then:

- a) The cost of this installation shall be met by Council. However Council may require an extension to any warranty and the payment of a bond to the value of replacing the product and any other cost, i.e. damage that may be incurred should the product fail.
- b) The product will be reviewed at intervals of 3, 6, 9 and 12 months to assess durability in a live situation.
- c) At the end of the specified trial period, members of the Project Evaluation Panel will inspect the product and determine if it is suitable for acceptance. Assessment will include identifying any signs of deterioration, distortion or other failure.
- d) The RITS Project Manager will notify the applicant of the trial outcome and advise of any further actions requirements (if any).

Once a decision has been reached, the process will conclude as specified in Clause 8.2.2 e) and f) above.

Note: A product undergoing a trial installation is not deemed to be an acceptable product.

8.2.5 Declining an Application

An application may be declined for one or more reasons as follows:

- a) The application form is not completed in full;
- b) The supporting information required is not supplied in full.
- c) The criteria listed in Clause 8.6 - Decision Process, do not meet Council's needs;
- d) The Product Evaluation Panel considers the product is not acceptable;
- e) The product fails any trial(s) undertaken.

Whatever the reason for declining an application, the applicant shall be advised of the reason(s) for decline.

Failure to have a product/material accepted does not mean it can never be used. It may be appropriate for use for a specific design reason but not appropriate for frequent use. (See [Section 1, Clause 1.1.42 : Alternative Design](#)). Approval shall be obtained from the Council to allow use of non-acceptable products/materials.

8.2.6 Removal from Acceptable Products List

Refer to [Clause 8.3](#) for details.

8.3 ACCEPTABLE PRODUCT LISTS

8.3.1 C1 : General Products

Table 8-1: General products

CATEGORY	APPLICATION	SIZING	PRODUCT	STANDARDS ²⁶	MANUFACTURER	LICENCE MARK #	EXPIRY DATE	COMMENTS
Common Pressure Pipe Assets	Stand Alone Flanges	DN80 to 225	Ductile/Cast Iron	AS/NZS 4087 AS/NZS 4158	Pipe and Infrastructure		xx/xx/20xx	Stand Alone Flanges; Ductile or Cast Iron coated
	Sluice Valves	DN80 to 225	Resilient Seated Gate Valves	AS/NZS 2638.2	Tyco			Anti-clockwise closing with Teflon gland packing or 2 or more “o” ring seals and dust cover. External and internal protective coating. Rated at PN16. Flanges to be raised face and drilled. Note that ductile iron must meet ASTM A536 65-45-12, EN 1563 EN-GJS-500/7 or equivalent.
AS/NZS 4158,				Hygrade				
AS/NZS 4087				Pipe & Infrastructure				
	Gate Valves	DN20 to 80						
	Bolts		Galvanised Bolts	AS/NZS 2312.2; BS 3692				Bolts, nuts and washers to be hot dipped galvanised with minimum of 15mm diameter
	Bolts		Stainless Bolts	AS/NZS 1252				Stainless steel bolts, nuts and washers are acceptable alternatives to hot dip galvanised fastenings provided they are 316 grade stainless steel with factory applied Molybond coating
Common Gravity	Manhole Risers for manholes less than	DN750	Roller Compacted	AS/NZS 4058;				

²⁶ Refer to the Reference Documents clause of the relevant section for title and date of the Standard.

CATEGORY	APPLICATION	SIZING	PRODUCT	STANDARDS 26	MANUFACTURER	LICENCE MARK #	EXPIRY DATE	COMMENTS
Drainage Assets	1m deep		or Centrifugally Spun Manufactured Concrete	NZS 3109; NZS 3114				
	Manhole Risers	DN105 0 to 2500	Roller Compacted or Centrifugally Spun Manufactured Concrete	AS/NZS 4058; NZS 3109; NZS 3114	Hynds Humes	Being updated		
		DN625 to 1000	Polyethylene Manholes and Maintenance Chambers	BS EN 13598- 2	Australasia Moulding Ltd	N 001015 (Austrian Standards)	Perpetuity while compliant	Manhole – used for less than 6m depth. Chambers – used for less than 2m depth.
	Manhole Lids & Frames		Ductile Iron Lid & Frame	AS 3996				Class D 600 diameter manhole lid & frame. Non-bolt down.
	Manhole Lids & Frames		Cast Iron Lid & Frame	AS 3996				Class D 600 diameter manhole lid & frame. Non-bolt down.

8.3.2 C2 : Water Supply Products

Table 8-2: Water supply products

CATEGORY	APPLICATION	SIZING	PRODUCT	STANDARDS	MANUFACTURER	LICENCE MARK #	EXPIRY DATE	COMMENTS
Water Supply	Trunk Mains	DN 250, 300 or 375 mm	PVC-O Pipe	AS/NZS 4441	Iplex	SMKP20682	Nov 2017	Series 2, PN 12.5, Design Material Class 355
				AS/NZS 4441	Marley	#2639		Date to be added
			Spiral welded steel	AS/NZS 4442	Steel Pipes	#2657 Dec 2023		3.2 mm wall thickness with concrete lining with Polyken Synergy Heat Fused Polyethylene 323mm OD - 1254mm OD or Polyken YGIII Cold Applied Polyethylene 323mm OD - 2030mm OD external coating
			Ductile iron	AS2280	Saint-Gobain Pam			5.0 to 7.9 for PN20 mm wall thickness with concrete lining and externally coated to suit the ground conditions.
	Principal Mains	DN 150 & 200 mm	PVC-O Pipe	AS/NZS 4441	Iplex	SMKP20400	2021	Series 2, PN 12.5, Design Material Class 355
					Marley	#2639		
					Pipemaker (Asmuss)	WM74556		
	Rider Mains	DN 50 mm & 40 mm	PE Pipe	AS/NZS 4130	Iplex	SMKP20400		PE80, PN12.5, SDR 11 (coloured blue or blue strip)
					Marley	#2639		

²⁷ Refer to the Reference Documents clause of the relevant section for title and date of the Standard.

CATEGORY	APPLICATION	SIZING	PRODUCT	STANDARDS	MANUFACTURER	LICENCE MARK #	EXPIRY DATE	COMMENTS
	Water Service Lines	DN 20, 25 & 50 mm	PE Pipe	AS/NZS 4130	Iplex	SMKP20400		PE80, PN12.5, SDR 11 (coloured Black with Blue jacket)
					Marley	#2639		
					RX Plastics	#002		
					Waters & Farr	#2729 (Whanganui), #2722 (Rangiora)		
	Rider Mains and Water Service Lines		PE mechanical fittings	AS/NZS 4129	Iplex	SMKO2018		Plasson Series 1
				AS/NZS 4130	Marley	#2639		
					Hansen	WMK21978	Sept 2020	Insert to be used to support pipe
					Plasson	WM02018 & AMI 02018		
	Rider Mains and Water Service Lines	DN 20,25, 40 and 50	PE Fittings Electrofusion	AS/NZS 4129	Plasson	WM02018 & AMI 02018		Line 7 range
	Water Service Lines	DN 15, 20, 25 mm	Manifolds	Nil		?		HCC accept a stainless steel manifold
	Water Service Lines	DN 50 mm	Stop Taps (Gate Valves)	BS EN 12288	ASMUSS Maxiflo			Dezincification resistant materials or LG2 gunmetal, with Malleable (cast) iron T bar handles. PN16 or higher.
		DN 80-600		AS 2638.2			SMKP 20171	
	Fire Hydrants			NZS 4522; Coating to AS/NZS 4158	Gillies AVK series 29			Tall (median allowed on existing mains) pattern screw down standard, with approved polyurethane cup washer. Pure PTFE gland packing or "O" ring sealing system. To be rated PN16 or higher.
					Tyco F502 Hygrade			
	Tapping Bands	DN 50 mm						a) LG2 gunmetal DR type – fully enclosed, b) Polyethylene type – fully enclosed with stainless steel bolts, c) Glass filled NORYL two part moulded with stainless steel bolts

CATEGORY	APPLICATION	SIZING	PRODUCT	STANDARDS	MANUFACTURER	LICENCE MARK #	EXPIRY DATE	COMMENTS
	Tapping Bands	DN 100 to 250 mm	'Water Meters intended for the metering of cold potable water'					a) LG2 gunmetal DR type. Fully enclosed for mPVC, blue brute, superblue, cast iron and spiral steel (AC sizing). Swivel bolt type with a flexible band for existing AC watermain; b) Glass filled NORYL two part moulded with stainless steel bolts
	Water Meters	DN < 50 mm		OIML R49				Manufactured with Class C measuring accuracy.
	Water Meters	DN 50 mm		OIML R49				All meter installations, 50mm and above, are subject to specific acceptance by the relevant TA. Suppliers listed on the Acceptable Products list will be contacted to assist in selecting a meter which is fit for purpose (e.g. Class B or C or combination meter).
	Water Meters	DN 100 & 150 mm	Electromagnetic Water Meter					Battery powered, minimum 4 year battery life.
	Water Meters	DN 100 & 150mm	ABB Water Master Electromagnetic Water Meter		ABB			Mains powered (230v)
	Backflow Prevention		Non-Testable Double Check (Low Risk)	AS/NZS 2845.1				Devices manufactured to satisfy the Water NZ publication 'Backflow Prevention for Drinking Water Suppliers Code of Practice', or ASSE Standards (American Society of Sanitary Engineers Standards)

CATEGORY	APPLICATION	SIZING	PRODUCT	STANDARDS	MANUFACTURE R	LICENCE MARK #	EXPIRY DATE	COMMENTS
	Backflow Prevention		Testable Double Check (Medium Risk)	AS/NZS 2845.1				Devices manufactured to satisfy the Water NZ publication 'Backflow Prevention for Drinking Water Suppliers Code of Practice', or ASSE Standards (American Society of Sanitary Engineers Standards)
	Backflow Prevention		Testable Reduced Pressure Zone Device (High Risk)	AS/NZS 2845.1	Watts			Devices manufactured to satisfy the Water NZ publication 'Backflow Prevention for Drinking Water Suppliers Code of Practice', or ASSE Standards (American Society of Sanitary Engineers Standards)
Miscellaneous Water Supply	Valve, Fire Hydrant, Meter Boxes, Packers & Valve Marker Plate			Standard Drawings				Cast iron to Standard Drawings. Polypropylene or polyethylene meter boxes with black or blue lids. Other colour lids may be installed only as approved. NOTE: Only cast iron meter boxes may be used in driveways or carriageways.
	Concrete Valve Marker Post			Standard Drawing D6.4				
	Fire Hydrant Concrete Surrounds			Standard Drawings D6.3				
	Valve Concrete Surrounds			Standard Drawings D6.2				
	Wooden Valve Post			Standard Drawing				
	Cast Iron Toby Box		Cast iron	Standard Drawing D6.7				
	Polyethylene Toby Box		Polyethylene	Standard Drawing D6.7				

CATEGORY	APPLICATION	SIZING	PRODUCT	STANDARDS	MANUFACTURER	LICENCE MARK #	EXPIRY DATE	COMMENTS
	mPVC Toby Box Riser	150 mm	mPVC	Standard Drawing D6.9	Iplex Marley			

8.3.3 C3 : Stormwater Products

Table 8-3: Stowmater products

CATEGORY	APPLICATION	SIZING	PRODUCT	STANDARDS	MANUFACTURER	LICENCE MARK #	EXPIRY DATE	COMMENTS
Stormwater	Stormwater Mains	DN 150 mm	PVC-U Pipe	AS/NZS 1254				Class SN16 RRJ
	Stormwater Mains	DN 225 to 600 mm	Centrifugally Spun Manufactured Concrete Pipes	AS/NZS 4058				Rubber Ring jointed Class 2, 3 & 4
	Stormwater Mains	>DN 600mm	PKS & Profix (PFX) Polyethylene (PE100) Profile (PR) Pipe	AS/NZS ISO 9001:2015; AS/NZS 5065; AS/NZS 4130				Consideration will only be given to pipe diameters greater than DN600mm.
	Single Catchpit Lead	DN 225 mm	Centrifugally Spun Manufactured Concrete Pipes	AS/NZS 4058				Rubber Ring jointed Class 2, 3 & 4.
	Double Catchpit Lead	DN 300 mm	Centrifugally Spun Manufactured Concrete Pipes	AS/NZS 4058				Rubber Ring jointed Class 2, 3 & 4.
	Single Dwelling	DN 100 mm	PVC-U Pipe	AS/NZS 1254				100mm diameter in private non-trafficked areas are to be SN6 RRJ and in private trafficked areas and all public areas are to be SN10 RRJ
	2 to 3 Dwellings	DN 150 mm	PVC-U Pipe	AS/NZS 1254				Class SN8 RRJ in private non-trafficked areas and SN16 RRJ in private trafficked and public areas
	Kerb outlet							90 degree and 45 degree ductile iron kerb outlets and associated rubber couple fitting use.

²⁸ Refer to the Reference Documents clause of the relevant section for title and date of the Standard.

8.3.4 Wastewater Products

Table 8-4: Wastewater products

CATEGORY	APPLICATION	SIZING	PRODUCT	STANDARDS	MANUFACTURER	LICENCE MARK #	EXPIRY DATE	COMMENTS
Wastewater	Wastewater Mains	DN 100 to 225 mm	PVC-U Pipe	AS/NZS 1260	Iplex	SMKP20400		Class SN16 RRJ DN 150 to 225mm. DN 100 SN10 RRJ With ongoing compliance.
					Marley	#2639		
					Waters & Farr	# 2730 (Whanganui)		
	Wastewater Connections	DN 100 to 150 mm	PVC-U Pipe	AS/NZS 1260				Class SN16 RRJ
Wastewater Pump Station	Rising Main	DN 40 to 600 mm	PE100 Polyethylene Pipe	AS/NZS 4130	Iplex	SMKP20400		PE100, PN 12+, coloured black with cream strip or jacket welded or flanged joints (fusion welded fittings are acceptable). With ongoing compliance.
					Marley	#2639		
					Waters & Farr	# 2730 (Whanganui)		
	Pumps		Flygt – size to suit application		Flygt			Pump options are; N type impellers. The available sizes are 3085, 3102, 3127 or 3153. Unless agreed with council, the impellers should be the medium head (MT) option.
	Pump Discharge Bend		Flygt – size to suit application		Flygt			To suit pump
	Guide Rail Brackets		Flygt		Flygt			Hot dip galvanised. To suit pump.
	Guide Rails	DN 50 mm	Stainless Steel Pipe					Schedule 10, 316 grade stainless steel. Any joints to be an internal pressed fit stainless steel sleeve.

²⁹ Refer to the Reference Documents clause of the relevant section for title and date of the Standard.

CATEGORY	APPLICATION	SIZING	PRODUCT	STANDARDS	MANUFACTURER	LICENCE MARK #	EXPIRY DATE	COMMENTS
	Pump Riser Pipe	DN 80 to 150 mm	Stainless Steel Pipe					Schedule 40, 316 grade stainless steel.
	Pump Backflow Prevention		Flap Check or Ball Check Valve	AS/NZS 4158 AS/NZS 4087				External and internal protective coating. Rated at PN16. Flanges to be raised face and drilled.
	Washdown Backflow Prevention	DN 50 mm	Testable Reduced Pressure Zone Device (High Risk)	AS/NZS 2845.1				Devices manufactured to satisfy the Water NZ publication 'Backflow Prevention for Drinking Water Suppliers Code of Practice', or ASSE Standards (American Society of Sanitary Engineers Standards)
	Flow Meter	Sized to suit the rising main	ABB Water Master potted for IP68		ABB			

8.3.5 Landscaping Products (to be developed)

Table 8-5: Landscaping products

CATEGORY	APPLICATION	SIZING	PRODUCT	STANDARDS ³⁰	MANUFACTURER	LICENCE MARK #	EXPIRY DATE	COMMENTS
Landscaping								

8.3.6 Transportation Products (to be developed)

Table 8-6: Transportation products

CATEGORY	APPLICATION	SIZING	PRODUCT	STANDARDS ³⁰	MANUFACTURER	LICENCE MARK #	EXPIRY DATE	COMMENTS
Roading								

³⁰ Refer to the Reference Documents clause of the relevant section for title and date of the Standard.



APPLICATION FOR ACCEPTANCE OF PRODUCT FOR INCLUSION IN REGIONAL INFRASTRUCTURE TECHNICAL SPECIFICATION

Product ID:

Purpose of Product:

Manufacturer:

Contact Person:

Contact Phone No.:

Installation Details:

Copies attached

Product Life (years):

Standard(s):

Licence Number:

Copy attached

Previously accepted by the following authorities:

Letter(s) attached

Signature of Applicant

Date

for Office Use only

Received by Regional ITS Project Manager

Letter(s) attached:

Yes

No

Date:

Receipt of application acknowledged

Letter(s) attached:

Yes

No

Date:

Further Information requested? :

Yes

No

Date:

Copy of application forwarded to Product Evaluation Panel

Forwarded by:

Date:

PRODUCT FORMALLY EVALUATED AT REVIEW MEETING

Attendees:

Date of meeting:

Product to be:

ACCEPTED

TRIALLED

DECLINED

Product trial required?

Yes

No

If yes, what arrangements have been made?

Appropriate action taken on (tick following as appropriate):

By whom:

Date:

ADDED TO ACCEPTABLE PRODUCTS

TRIAL ORGANISED

APPLICANT ADVISED